

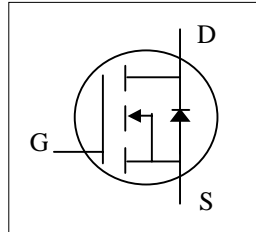

- ▼ Low Gate Charge
- ▼ Fast Switching Characteristics
- ▼ Simple Drive Requirement



BV_{DSS}	600V
$R_{DS(ON)}$	12 Ω
I_D	160mA

Description

Advanced Power MOSFETs utilized advanced processing techniques to achieve the lowest possible on-resistance, extremely efficient and cost-effectiveness device.

The TO-92 package is widely used for commercial-industrial applications.

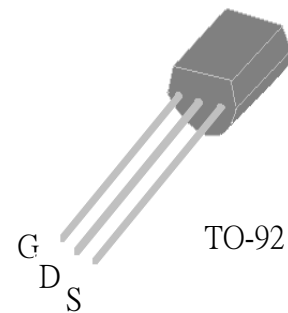

Absolute Maximum Ratings

Symbol	Parameter	Rating	Units
V_{DS}	Drain-Source Voltage	600	V
V_{GS}	Gate-Source Voltage	± 30	V
$I_D @ T_A=25^\circ C$	Continuous Drain Current, V_{GS} @ 10V	160	mA
$I_D @ T_A=100^\circ C$	Continuous Drain Current, V_{GS} @ 10V	100	mA
I_{DM}	Pulsed Drain Current ¹	300	mA
$P_D @ T_A=25^\circ C$	Total Power Dissipation	0.83	W
T_{STG}	Storage Temperature Range	-55 to 150	$^\circ C$
T_J	Operating Junction Temperature Range	-55 to 150	$^\circ C$

Thermal Data

Symbol	Parameter	Value	Unit
Rthj-a	Maximum Thermal Resistance, Junction-ambient	150	$^\circ C/W$



AP01L60AT

Electrical Characteristics @T_j=25°C(unless otherwise specified)

Symbol	Parameter	Test Conditions	Min.	Typ.	Max.	Units
BV _{DSS}	Drain-Source Breakdown Voltage	V _{GS} =0V, I _D =1mA	600	-	-	V
ΔBV _{DSS} /ΔT _j	Breakdown Voltage Temperature Coefficient	Reference to 25°C, I _D =1mA	-	0.8	-	V/°C
R _{DS(ON)}	Static Drain-Source On-Resistance ²	V _{GS} =10V, I _D =0.5A	-	-	12	Ω
V _{GS(th)}	Gate Threshold Voltage	V _{DS} =V _{GS} , I _D =250uA	2	-	4	V
g _{fs}	Forward Transconductance	V _{DS} =10V, I _D =0.5A	-	0.8	-	S
I _{DSS}	Drain-Source Leakage Current (T _j =25°C)	V _{DS} =600V, V _{GS} =0V	-	-	10	uA
	Drain-Source Leakage Current (T _j =150°C)	V _{DS} =480V, V _{GS} =0V	-	-	100	uA
I _{GSS}	Gate-Source Leakage	V _{GS} = ± 30V	-	-	±100	nA
Q _g	Total Gate Charge ²	I _D =0.1A	-	6.0	10	nC
Q _{gs}	Gate-Source Charge	V _{DS} =480V	-	1.0	-	nC
Q _{gd}	Gate-Drain ("Miller") Charge	V _{GS} =10V	-	2.5	-	nC
t _{d(on)}	Turn-on Delay Time ²	V _{DD} =300V	-	6.6	-	ns
t _r	Rise Time	I _D =1A	-	5.0	-	ns
t _{d(off)}	Turn-off Delay Time	R _G =3.3Ω, V _{GS} =10V	-	11.7	-	ns
t _f	Fall Time	R _D =300Ω	-	9.2	-	ns
C _{iss}	Input Capacitance	V _{GS} =0V	-	170	270	pF
C _{oss}	Output Capacitance	V _{DS} =25V	-	30.7	-	pF
C _{rss}	Reverse Transfer Capacitance	f=1.0MHz	-	5.1	-	pF

Source-Drain Diode

Symbol	Parameter	Test Conditions	Min.	Typ.	Max.	Units
I _S	Continuous Source Current (Body Diode)	V _D =V _G =0V , V _S =1.2V	-	-	160	mA
V _{SD}	Forward On Voltage ²	I _S =160mA, V _{GS} =0V	-	-	1.2	V

Notes:

- 1.Pulse width limited by Max. junction temperature.
- 2.Pulse test

THIS PRODUCT IS AN ELECTROSTATIC SENSITIVE, PLEASE HANDLE WITH CAUTION.

THIS PRODUCT HAS BEEN QUALIFIED FOR CONSUMER MARKET. APPLICATIONS OR USES AS CRITERIAL COMPONENT IN LIFE SUPPORT DEVICE OR SYSTEM ARE NOT AUTHORIZED.

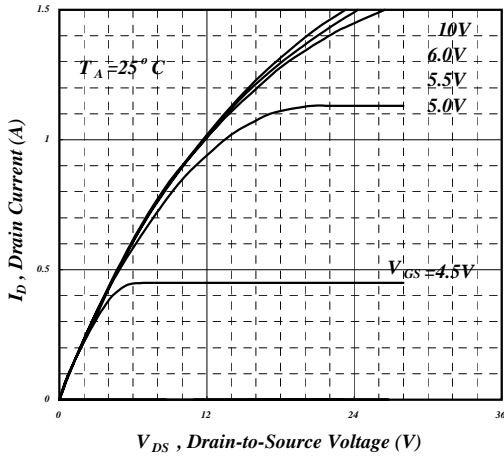

Fig 1. Typical Output Characteristics

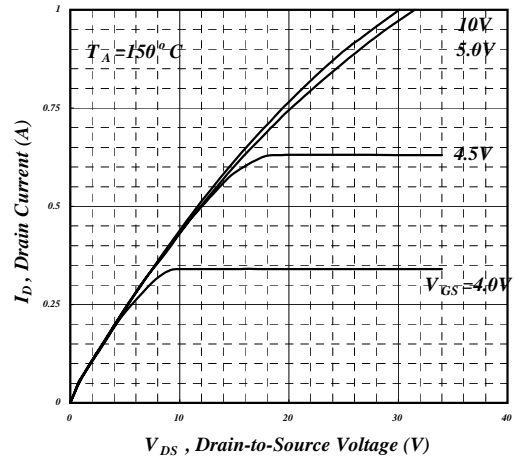

Fig 2. Typical Output Characteristics

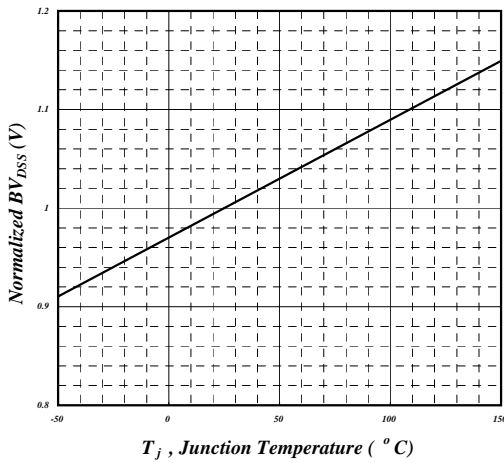

Fig 3. Normalized BV_{DSS} v.s. Junction Temperature

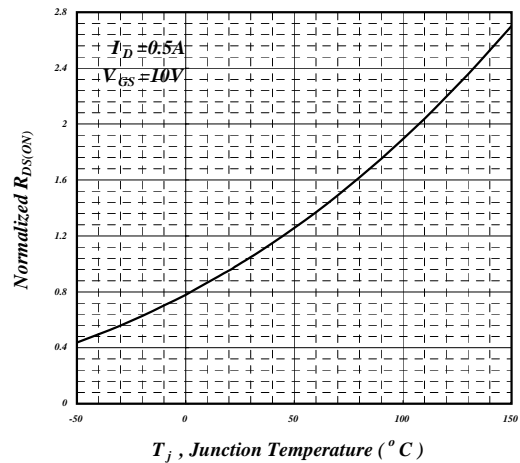

Fig 4. Normalized On-Resistance v.s. Junction Temperature

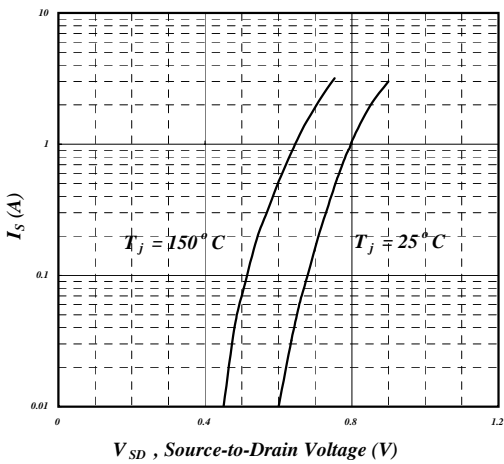

Fig 5. Forward Characteristic of Reverse Diode

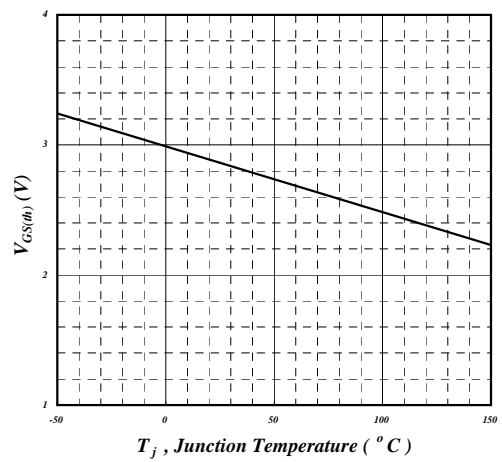

Fig 6. Gate Threshold Voltage v.s. Junction Temperature

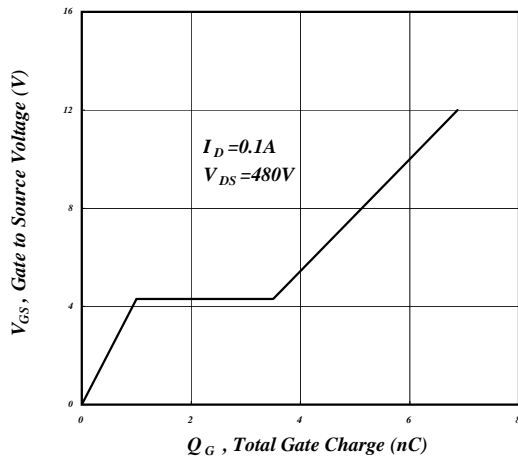

Fig 7. Gate Charge Characteristics

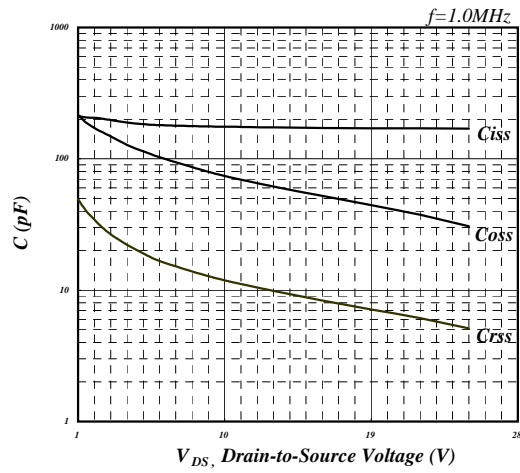

Fig 8. Typical Capacitance Characteristics

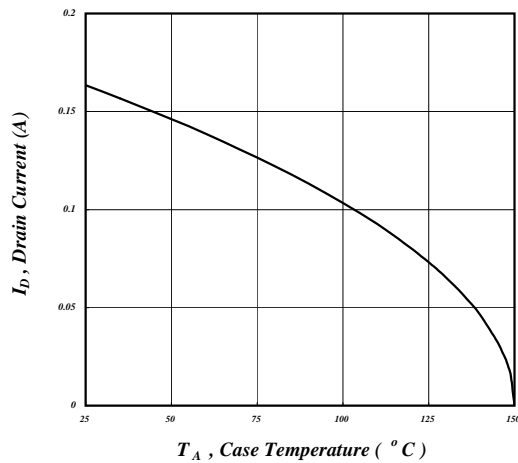

Fig 9. Maximum Drain Current v.s. Case Temperature

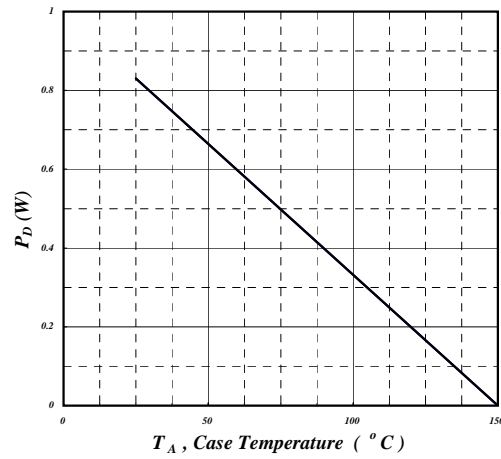

Fig 10. Typical Power Dissipation

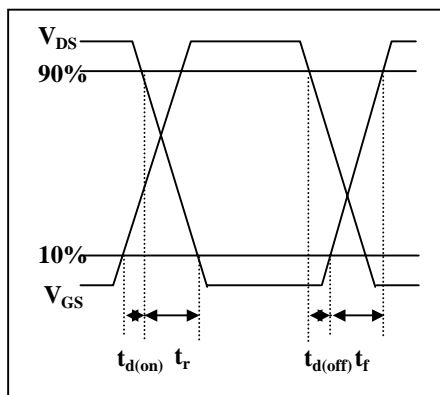

Fig 11. Switching Time Waveform

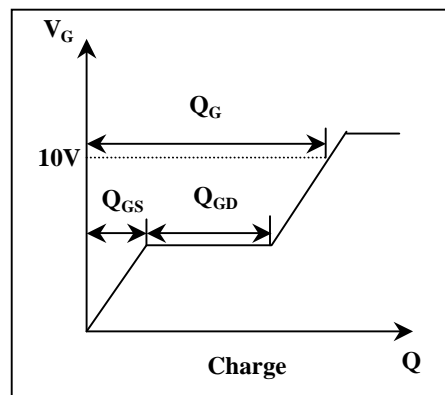
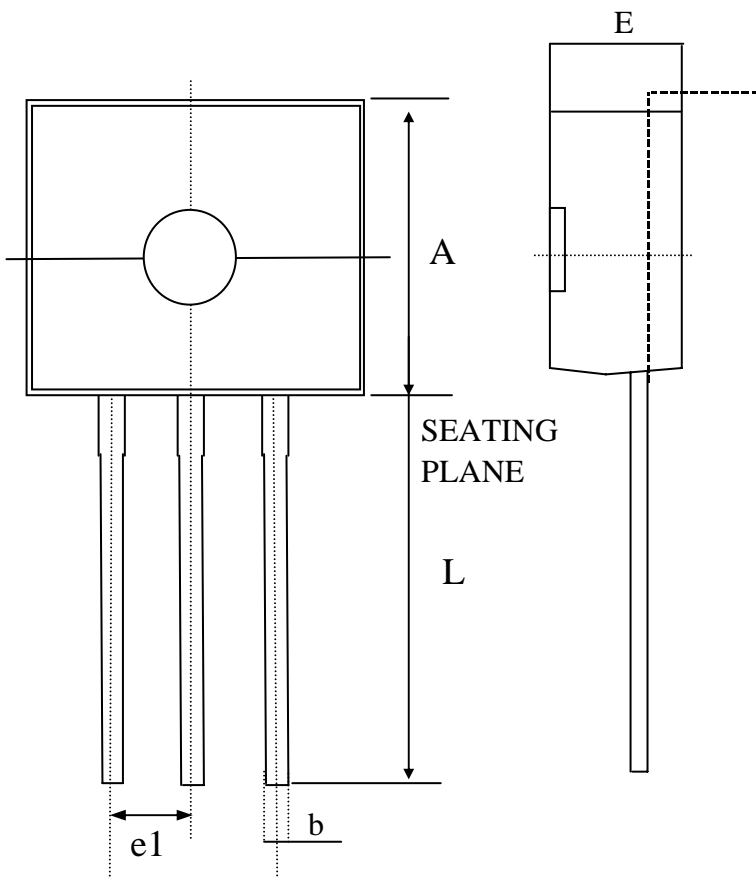

Fig 12. Gate Charge Waveform



Package Outline : TO-92



SYMBOL	Millimeters		
	MIN	NOM	MAX
A	4.32	4.83	5.34
D	4.1	4.8	5.3
E	3.1	3.9	4.7
b	----	0.38	----
L	12.7	---	----
e1	----	1.27	----

1. All Dimensions Are in Millimeters.
2. Dimension Does Not Include Mold Protrusions.

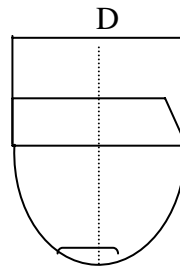

Part Marking Information & Packing : TO-92

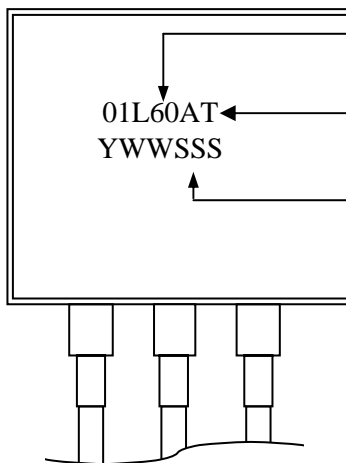

Part Number

01L60AT
YWWSSS

Package Code

Date Code (YWWSSS)

Y : Last Digit Of The Year

WW : Week

SSS : Sequence