

DESCRIPTION

This Microsemi Powermite® surface mount low noise Zener package series provides a higher power handling capability that are also RoHS compliant. In addition to its size advantages, Powermite® package features include a full-metallic bottom that eliminates the possibility of solder flux entrapment during assembly, and a unique locking tab acts as an efficient heat path from die to mounting plane for external heat sinking with very low thermal resistance junction to case (bottom). Its innovative design makes this device ideal for use with automatic insertion equipment.

IMPORTANT: For the most current data, consult MICROSEMI's website: <http://www.microsemi.com>

APPEARANCE



DO-216

FEATURES

- Surface mount equivalent to JEDEC registered 1N4099 thru 1N4135 and 1N4614 thru 1N4627 series except with additional power capability
- Extensive selection from 1.8 to 100 V
- Regulates voltage over a broad operating current and temperature range
- Low noise density (1-3 kHz) at test current
- Low reverse leakage current
- RoHS compliant

MAXIMUM RATINGS

- Operating and Storage Temperatures: -55°C to +150°C
- Steady-State Power: 1.0 watt at $T_C \leq 120^\circ\text{C}$ where T_C is case bottom temperature at mounting plane, or 0.5 watts at $T_A = 30^\circ\text{C}$ (ambient temperature) when mounted on FR4 PC board as described for thermal resistance (also see power deratings in Figure 1)
- Thermal Resistance: 30°C/W junction to case (bottom) and 240°C/W junction to ambient on FR4 PC board (1 oz copper) with recommended footprint (see last page)
- Forward voltage: 1.1 Volts @ 200 mA
- Solder Temperatures: 260°C for 10 s (max)

APPLICATIONS / BENEFITS

- Tight tolerances available in plus or minus 2% or 1% with C or D suffix respectively
- Moisture classification Level 1 per IPC/JEDEC J-STD-020B with no dry pack required
- Nonsensitive to ESD per MIL-STD-750 Method 1020
- Compatible with automatic insertion equipment
- Full metallic bottom eliminates flux entrapment

MECHANICAL AND PACKAGING

- CASE: Void-free transfer molded thermosetting epoxy compound meeting UL94V-0
- FINISH: Annealed matte-Tin plating over copper and readily solderable per MIL-STD-750 method 2026 (consult factory for Tin-Lead plating)
- POLARITY: Cathode designated by Tab 1 (bottom)
- MARKING: Three numerical digits of P/N and a dot (see next page listing)
- WEIGHT: 0.016 grams (approx.)
- Package dimensions on last page
- Tape & Reel option: Standard per EIA-481-B
3000 on 7 inch reel and 12,000 on 13" reel



1PMT4614e3 thru 1PMT4627e3,
1PMT4099e3 thru 1PMT4135e3

POWERMITE™
Low Noise 1 Watt Zener Diodes

ELECTRICAL CHARACTERISTICS @ 25°C

PART NUMBER (4)	DEVICE MARKING	NOMINAL ZENER VOLTAGE (1)	ZENER TEST CURRENT	MAXIMUM ZENER IMPEDANCE (2)	MAXIMUM REVERSE CURRENT		MAXIMUM NOISE DENSITY	MAXIMUM ZENER CURRENT (3)	TYPICAL TEMPERATURE COEFFICIENT OF ZENER VOLTAGE
		$V_Z @ I_{ZT}$	I_{ZT}	Z_{ZT}	$I_R @ V_R$		$N_D @ I_{ZT}$	I_{ZM}	α_{VZ}
		VOLTS	μA	OHMS	μA	VOLTS	$\mu V/\sqrt{HZ}$	mA	%/°C
1PMT4614	614*	1.8	250	1200	7.5	1.0	1	262.4	-0.075
1PMT4615	615*	2.0	250	1250	5.0	1.0	1	240.6	-0.075
1PMT4616	616*	2.2	250	1300	4.0	1.0	1	218.7	-0.075
1PMT4617	617*	2.4	250	1400	2.0	1.0	1	207.8	-0.075
1PMT4618	618*	2.7	250	1500	1.0	1.0	1	196.8	-0.075
1PMT4619	619*	3.0	250	1600	0.8	1.0	1	190.3	-0.075
1PMT4620	620*	3.3	250	1650	7.5	1.5	1	185.9	-0.075
1PMT4621	621*	3.6	250	1700	7.5	2.0	1	181.5	-0.065
1PMT4622	622*	3.9	250	1650	5.0	2.0	1	174.9	-0.060
1PMT4623	623*	4.3	250	1600	4.0	2.0	1	168.4	-0.050
1PMT4624	624*	4.7	250	1550	10	3.0	1	164.0	-0.040 +0.020
1PMT4625	625*	5.1	250	1500	10	3.0	2	153.1	-0.045 +0.030
1PMT4626	626*	5.6	250	1400	10	4.0	4	142.2	-0.020 +0.040
1PMT4627	627*	6.2	250	1200	10	5.0	5	133.4	-0.010 +0.050
1PMT4099	099*	6.8	250	200	10	5.17	40	122.5	0.040
1PMT4100	100*	7.5	250	200	10	5.70	40	111.5	0.045
1PMT4101	101*	8.2	250	200	1.0	6.24	40	100.6	0.048
1PMT4102	102*	8.7	250	200	1.0	6.61	40	96.2	0.049
1PMT4103	103*	9.1	250	200	1.0	6.92	40	91.9	0.050
1PMT4104	104*	10	250	200	1.0	7.60	40	83.1	0.055
1PMT4105	105*	11	250	200	.05	8.44	40	76.5	0.060
1PMT4106	106*	12	250	200	.05	9.12	40	69.9	0.065
1PMT4107	107*	13	250	200	.05	9.87	40	63.4	0.065
1PMT4108	108*	14	250	200	.05	10.65	40	59.0	0.070
1PMT4109	109*	15	250	100	.05	11.40	40	54.8	0.070
1PMT4110	110*	16	250	100	.05	12.15	40	52.5	0.070
1PMT4111	111*	17	250	100	.05	12.92	40	48.1	0.075
1PMT4112	112*	18	250	100	.05	13.37	40	45.9	0.075
1PMT4113	113*	19	250	150	.05	14.44	40	43.7	0.075
1PMT4114	114*	20	250	150	.01	15.20	40	41.6	0.075
1PMT4115	115*	22	250	150	.01	16.72	40	37.2	0.080
1PMT4116	116*	24	250	150	.01	18.25	40	34.9	0.080
1PMT4117	117*	25	250	150	.01	19.00	40	32.8	0.080
1PMT4118	118*	27	250	150	.01	20.45	40	30.6	0.085
1PMT4119	119*	28	250	200	.01	21.28	40	30.6	0.085
1PMT4120	120*	30	250	200	.01	22.80	40	28.4	0.085
1PMT4121	121*	33	250	200	.01	25.08	40	26.2	0.085
1PMT4122	122*	36	250	200	.01	27.38	40	24.0	0.090
1PMT4123	123*	39	250	200	.01	29.65	40	21.4	0.090
1PMT4124	124*	43	250	250	.01	32.65	40	19.5	0.090
1PMT4125	125*	47	250	250	.01	35.75	40	17.7	0.090
1PMT4126	126*	51	250	300	.01	38.76	40	16.4	0.090
1PMT4127	127*	56	250	300	.01	42.60	40	14.7	0.090
1PMT4128	128*	60	250	400	.01	45.60	40	13.9	0.090
1PMT4129	129*	62	250	500	.01	47.10	40	13.3	0.090
1PMT4130	130*	68	250	700	.01	51.68	40	12.2	0.095
1PMT4131	131*	75	250	700	.01	57.00	40	11.2	0.095
1PMT4132	132*	82	250	800	.01	62.32	40	10.1	0.095
1PMT4133	133*	87	250	1000	.01	66.12	40	9.6	0.095
1PMT4134	134*	91	250	1200	.01	69.16	40	9.2	0.095
1PMT4135	135*	100	250	1500	.01	76.00	40	8.3	0.095

NOTE 1: Product shown has a standard tolerance of $\pm 5\%$ on the nominal zener voltage. Also available in 2% and 1% tolerance with suffix C and D respectively. V_Z is measured at I_{ZT} with T_c (TAB 1) at 30°C.

NOTE 2: Zener impedance is derived by superimposing on I_{ZT} a 60 Hz rms ac current equal to 10% of I_{ZT} (25 μA ac).

NOTE 3: Based on 1 W maximum power dissipation before any derating. Allowance has been made for higher voltage with operation at higher currents and temperature. For determination of voltage change with current deviations from I_{ZT} see Micro Note 202

NOTE 4: Part number should also include the e3 suffix since the only option is for RoHS Compliant product.

www.Microsemi.com

1PMT4614e3 - 27e3 &
1PMT4099e3 - 4135e3

▶ **GRAPHS AND TEST CIRCUIT**

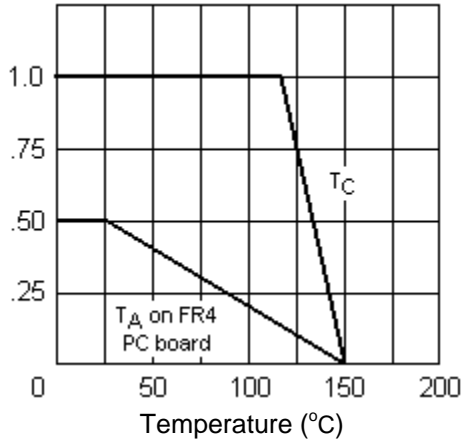
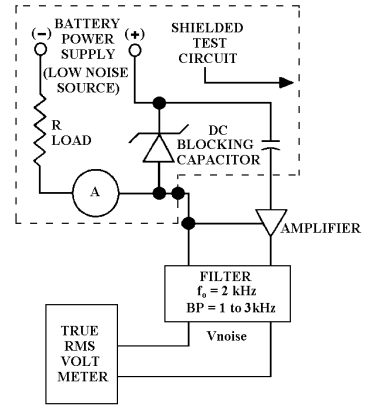

FIGURE 1

Power Derating Curve Where T_c is case (bottom) temperature and T_A is Ambient Temperature on FR4 PC board



NOISE TEST CIRCUIT
FIGURE 2

CAPACITANCE vs. V_Z CURVE

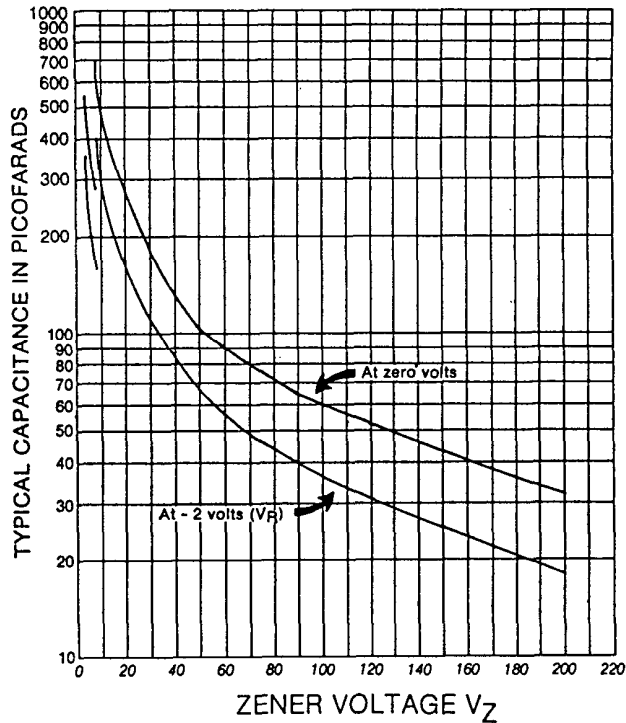
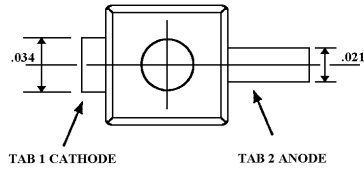

FIGURE 3

PACKAGE DIMENSIONS & PAD LAYOUT



TAB 1 CATHODE

TAB 2 ANODE

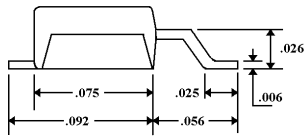

All dimensions +/- .005 inches

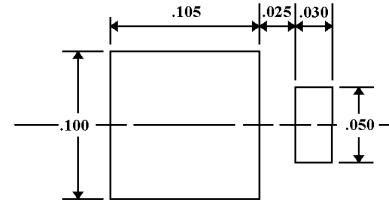
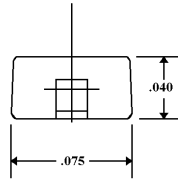

MOUNTING PAD in inches