

Super Junction MOSFET

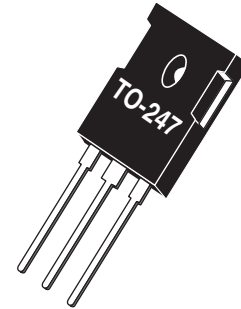

- Ultra low $R_{DS(ON)}$
- Increased Power Dissipation
- Low Miller Capacitance
- Ultra Low Gate Charge, Q_g
- Avalanche Energy Rated
- TO-247 or Surface Mount D³PAK Package



MAXIMUM RATINGS

All Ratings: $T_C = 25^\circ\text{C}$ unless otherwise specified.

Symbol	Parameter	APT47N65BC3	UNIT
V_{DSS}	Drain-Source Voltage	650	Volts
I_D	Continuous Drain Current @ $T_C = 25^\circ\text{C}$	47	Amps
I_{DM}	Pulsed Drain Current ¹	141	
V_{GS}	Gate-Source Voltage Continuous	± 20	Volts
V_{GSM}	Gate-Source Voltage Transient	± 30	
P_D	Total Power Dissipation @ $T_C = 25^\circ\text{C}$	417	Watts
	Linear Derating Factor	3.33	W/ $^\circ\text{C}$
T_J, T_{STG}	Operating and Storage Junction Temperature Range	-55 to 150	$^\circ\text{C}$
T_L	Lead Temperature: 0.063" from Case for 10 Sec.	260	
dv/dt	Drain-Source Voltage slope ($V_{DS} = 480\text{V}$, $I_D = 47\text{A}$, $T_J = 125^\circ\text{C}$)	50	V/ns
I_{AR}	Repetitive Avalanche Current ⁷	20	Amps
E_{AR}	Repetitive Avalanche Energy ⁷	1	mJ
E_{AS}	Single Pulse Avalanche Energy ⁴	1800	

STATIC ELECTRICAL CHARACTERISTICS

Symbol	Characteristic / Test Conditions	MIN	TYP	MAX	UNIT
BV_{DSS}	Drain-Source Breakdown Voltage ($V_{GS} = 0\text{V}$, $I_D = 250\mu\text{A}$)	650			Volts
$R_{DS(on)}$	Drain-Source On-State Resistance ² ($V_{GS} = 10\text{V}$, $I_D = 30\text{A}$)		0.06	0.07	Ohms
I_{DSS}	Zero Gate Voltage Drain Current ($V_{DS} = 650\text{V}$, $V_{GS} = 0\text{V}$)		0.5	25	μA
	Zero Gate Voltage Drain Current ($V_{DS} = 650\text{V}$, $V_{GS} = 0\text{V}$, $T_J = 150^\circ\text{C}$)			250	
I_{GSS}	Gate-Source Leakage Current ($V_{GS} = \pm 20\text{V}$, $V_{DS} = 0\text{V}$)			± 100	nA
$V_{GS(th)}$	Gate Threshold Voltage ($V_{DS} = V_{GS}$, $I_D = 2.7\text{mA}$)	2.10	3	3.9	Volts

 CAUTION: These Devices are Sensitive to Electrostatic Discharge. Proper Handling Procedures Should Be Followed.

"COOLMOS™" comprise a new family of transistors developed by Infineon Technologies AG. "COOLMOS" is a trademark of Infineon Technologies AG."

Microsemi Website - <http://www.microsemi.com>

DYNAMIC CHARACTERISTICS

APT47N65BC3

Symbol	Characteristic	Test Conditions	MIN	TYP	MAX	UNIT
C_{iss}	Input Capacitance	$V_{GS} = 0V$ $V_{DS} = 25V$ $f = 1\text{ MHz}$		7015		pF
C_{oss}	Output Capacitance			2565		
C_{rss}	Reverse Transfer Capacitance			210		
Q_g	Total Gate Charge ³	$V_{GS} = 10V$ $V_{DD} = 300V$ $I_D = 47A @ 25^\circ C$		260		nC
Q_{gs}	Gate-Source Charge			29		
Q_{gd}	Gate-Drain ("Miller") Charge			110		
$t_{d(on)}$	Turn-on Delay Time	RESISTIVE SWITCHING $V_{GS} = 13V$ $V_{DD} = 380V$ $I_D = 47A @ 125^\circ C$ $R_G = 1.8\Omega$		18		ns
t_r	Rise Time			27		
$t_{d(off)}$	Turn-off Delay Time			110		
t_f	Fall Time			8		
E_{on}	Turn-on Switching Energy ⁶	INDUCTIVE SWITCHING @ 25°C $V_{DD} = 400V, V_{GS} = 15V$ $I_D = 47A, R_G = 5\Omega$		670		μJ
E_{off}	Turn-off Switching Energy			980		
E_{on}	Turn-on Switching Energy ⁶	INDUCTIVE SWITCHING @ 125°C $V_{DD} = 400V, V_{GS} = 15V$ $I_D = 47A, R_G = 5\Omega$		1100		
E_{off}	Turn-off Switching Energy			1200		

SOURCE-DRAIN DIODE RATINGS AND CHARACTERISTICS

Symbol	Characteristic / Test Conditions	MIN	TYP	MAX	UNIT
I_S	Continuous Source Current (Body Diode)			47	Amps
I_{SM}	Pulsed Source Current ¹ (Body Diode)			141	
V_{SD}	Diode Forward Voltage ² ($V_{GS} = 0V, I_S = -47A$)			1.2	Volts
t_{rr}	Reverse Recovery Time ($I_S = -47A, di_S/dt = 100A/\mu s, V_R = 350V$)		580		ns
Q_{rr}	Reverse Recovery Charge ($I_S = -47A, di_S/dt = 100A/\mu s, V_R = 350V$)		23		μC
dv/dt	Peak Diode Recovery dv/dt ⁵			6	V/ns

THERMAL CHARACTERISTICS

Symbol	Characteristic	MIN	TYP	MAX	UNIT
$R_{\theta JC}$	Junction to Case			0.30	$^\circ C/W$
$R_{\theta JA}$	Junction to Ambient			62	

① Repetitive Rating: Pulse width limited by maximum junction temperature

② Pulse Test: Pulse width < 380 μs , Duty Cycle < 2%

③ See MIL-STD-750 Method 3471

④ Starting $T_J = +25^\circ C, L = 36.0mH, R_G = 25\Omega, \text{Peak } I_L = 10A$

⑤ dv/dt numbers reflect the limitations of the test circuit rather than the device itself. $I_S = -I_D 47A, di/dt = 700A/\mu s, V_R = V_{DSS}, T_J = 150^\circ C$

⑥ E_{on} includes diode reverse recovery. See figures 18, 20.

⑦ Repetitive avalanche causes additional power losses that can be calculated as $P_{AV} = E_{AR} * f$

Microsemi Reserves the right to change, without notice, the specifications and information contained herein.

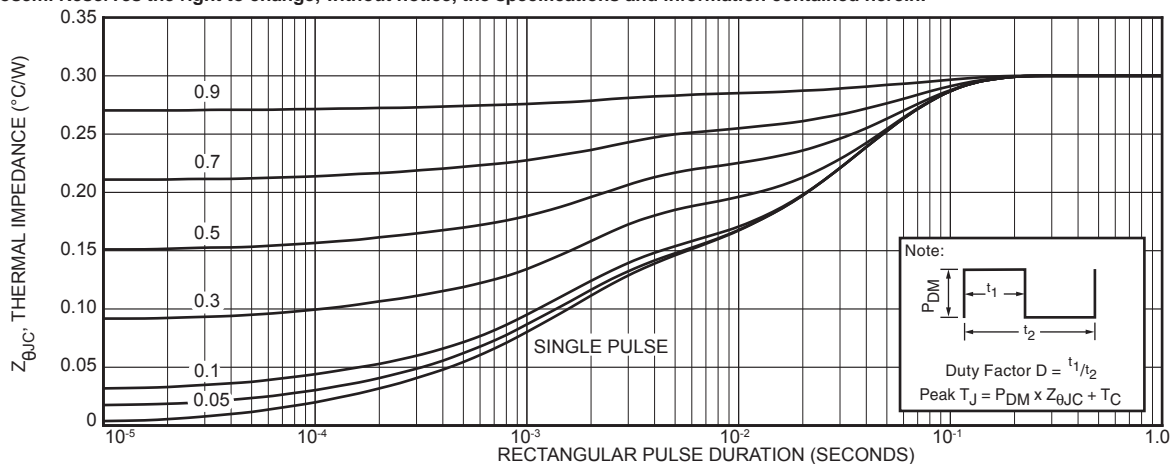

FIGURE 1, MAXIMUM EFFECTIVE TRANSIENT THERMAL IMPEDANCE, JUNCTION-TO-CASE vs PULSE DURATION

Typical Performance Curves

APT47N65BC3

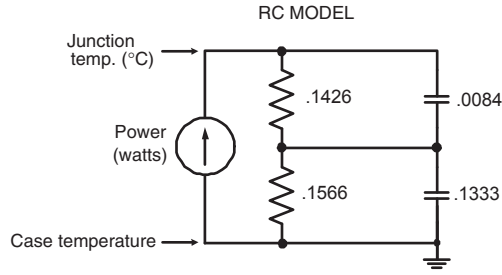

FIGURE 2, TRANSIENT THERMAL IMPEDANCE MODEL

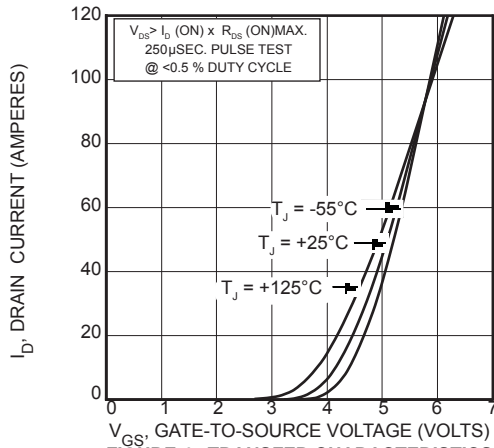

FIGURE 4, TRANSFER CHARACTERISTICS

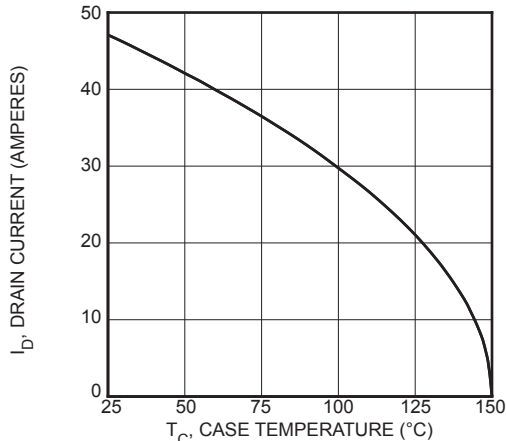

FIGURE 6, MAXIMUM DRAIN CURRENT vs CASE TEMPERATURE

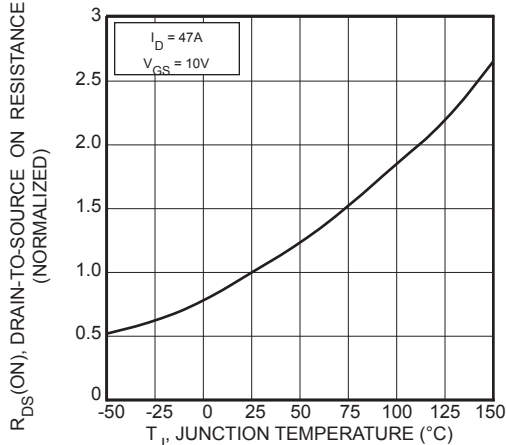

FIGURE 8, ON-RESISTANCE vs. TEMPERATURE

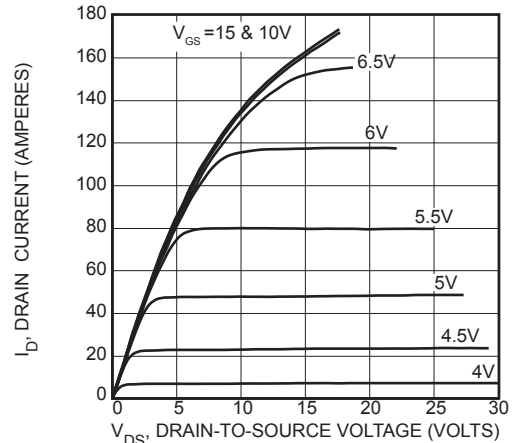

FIGURE 3, LOW VOLTAGE OUTPUT CHARACTERISTICS

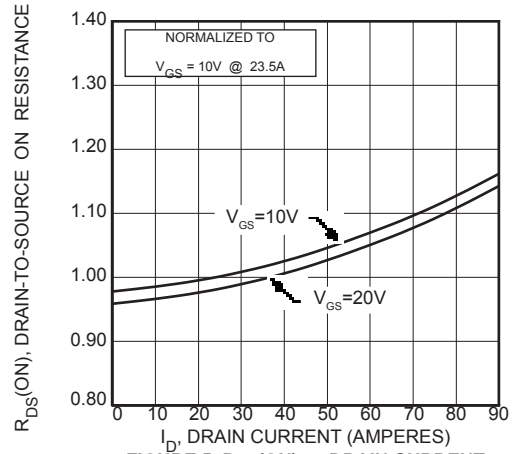

FIGURE 5, $R_{DS(ON)}$ vs DRAIN CURRENT

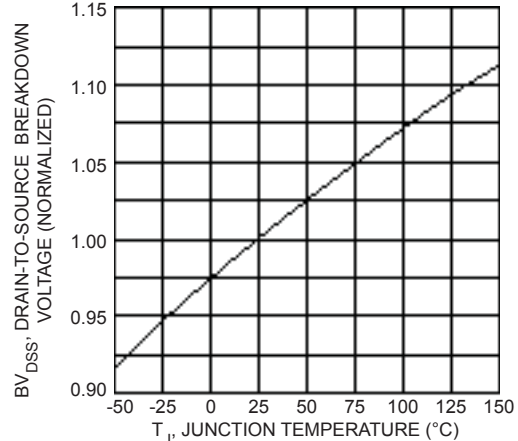

FIGURE 7, BREAKDOWN VOLTAGE vs TEMPERATURE

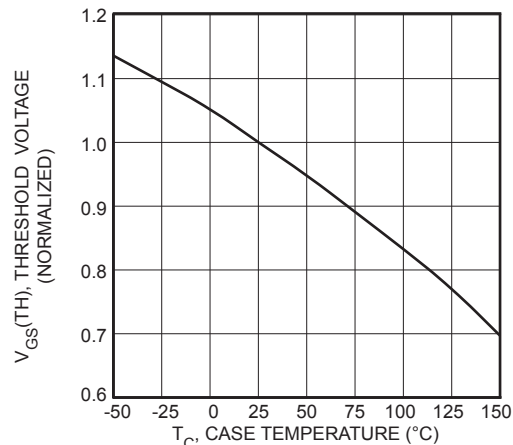

FIGURE 9, THRESHOLD VOLTAGE vs TEMPERATURE

Typical Performance Curves

APT47N65BC3

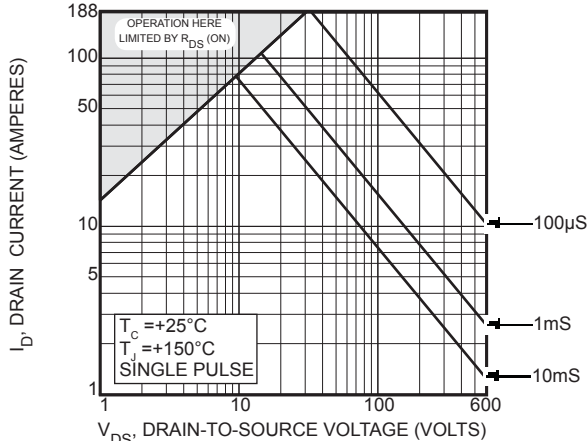

FIGURE 10, MAXIMUM SAFE OPERATING AREA

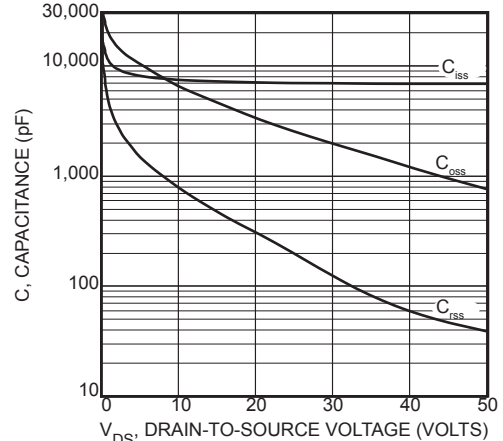

FIGURE 11, CAPACITANCE vs DRAIN-TO-SOURCE VOLTAGE

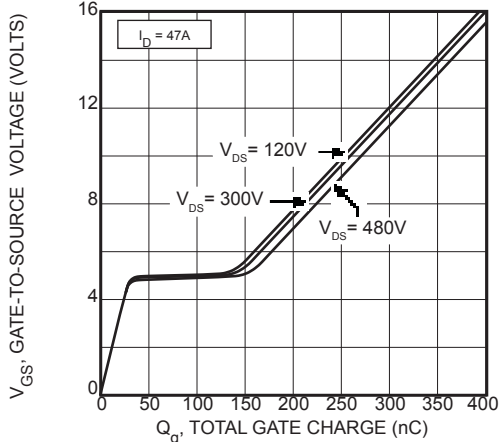

FIGURE 12, GATE CHARGES vs GATE-TO-SOURCE VOLTAGE

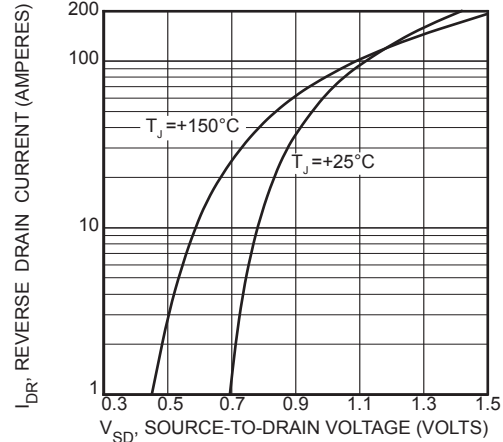

FIGURE 13, SOURCE-DRAIN DIODE FORWARD VOLTAGE

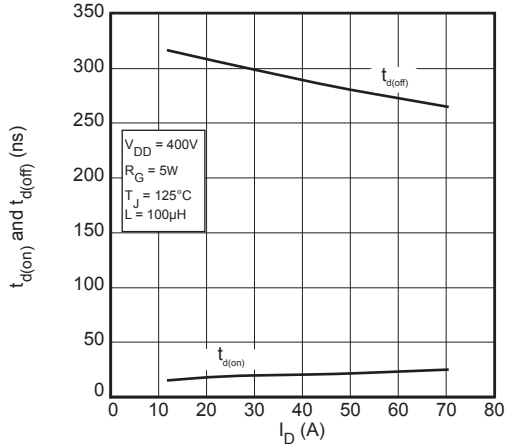

FIGURE 14, DELAY TIMES vs CURRENT

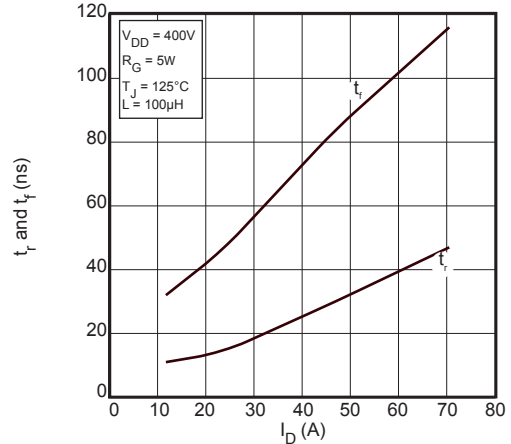

FIGURE 15, RISE AND FALL TIMES vs CURRENT

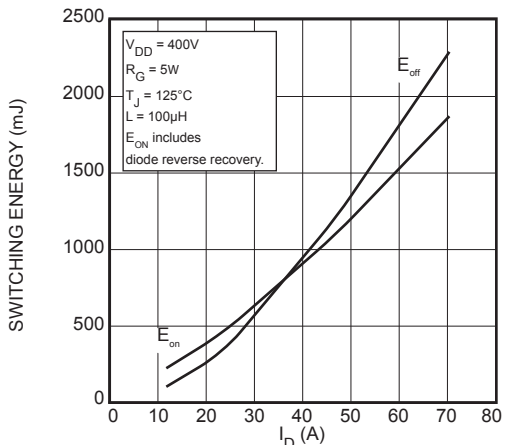

FIGURE 16, SWITCHING ENERGY vs CURRENT

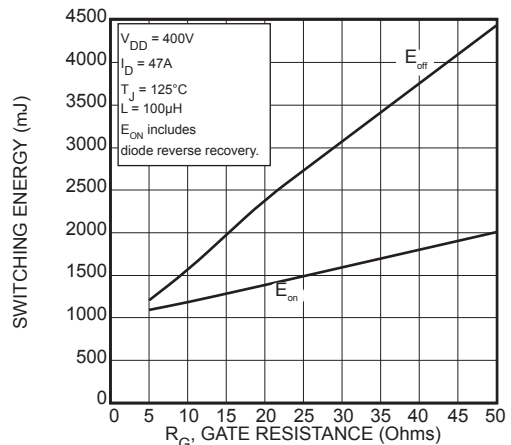

FIGURE 17, SWITCHING ENERGY vs. GATE RESISTANCE

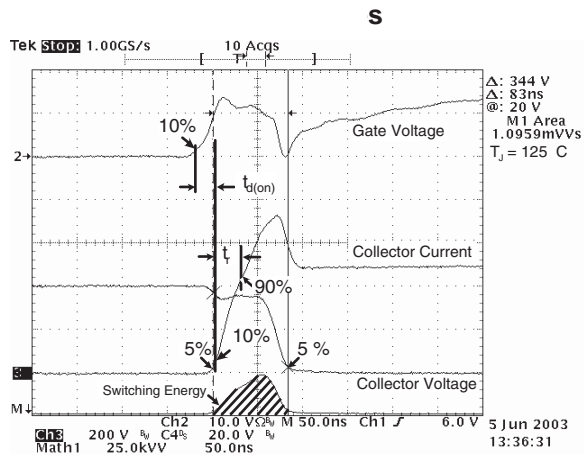

Figure 18, Turn-on Switching Waveforms and Definitions

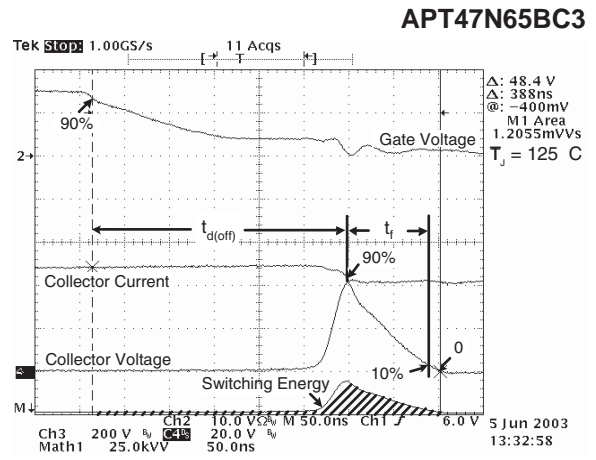

Figure 19, Turn-off Switching Waveforms and Definitions

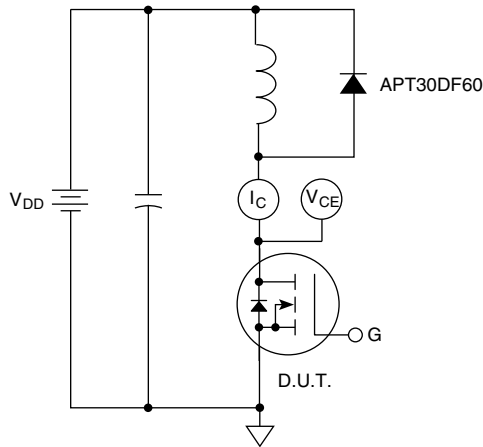
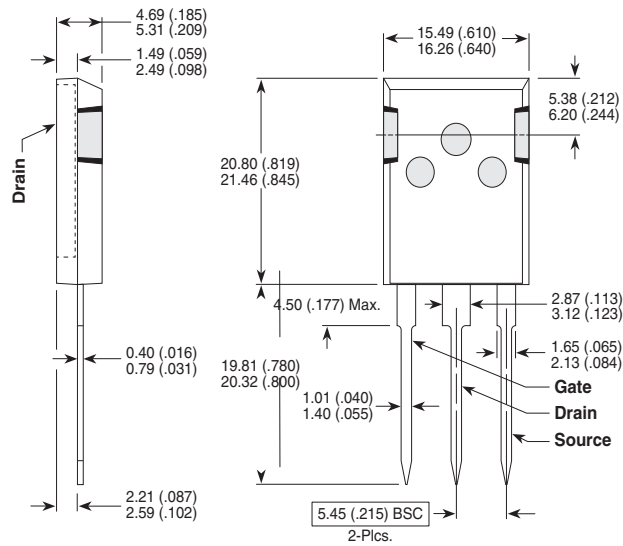

Figure 20, Inductive Switching Test Circuit

TO-247 Package Outline



These dimensions are equal to the TO-247 without the mounting hole.

Dimensions in Millimeters and (Inches)

Microsemi's products are covered by one or more of U.S. patents 4,895,810 5,045,903 5,089,434 5,182,234 5,019,522 5,262,336 6,503,786 5,256,583 4,748,103 5,283,202 5,231,474 5,434,095 5,528,058 6,939,743, 7,352,045 5,283,201 5,801,417 5,648,283 7,196,634 6,664,594 7,157,886 6,939,743 7,342,262 and foreign patents. US and Foreign patents pending. All Rights Reserved.