

MITSUBISHI HVIGBT MODULES
CM800E2Z-66H

2nd-Version HVIGBT (High Voltage Insulated Gate Bipolar Transistor) Modules

HIGH POWER SWITCHING USE
INSULATED TYPE

CM800E2Z-66H



- IC.....800A
- VCES 3300V
- Insulated Type
- 1-elements in a pack (for brake)

APPLICATION

DC choppers, Dynamic braking choppers.

OUTLINE DRAWING & CIRCUIT DIAGRAM

Dimensions in mm

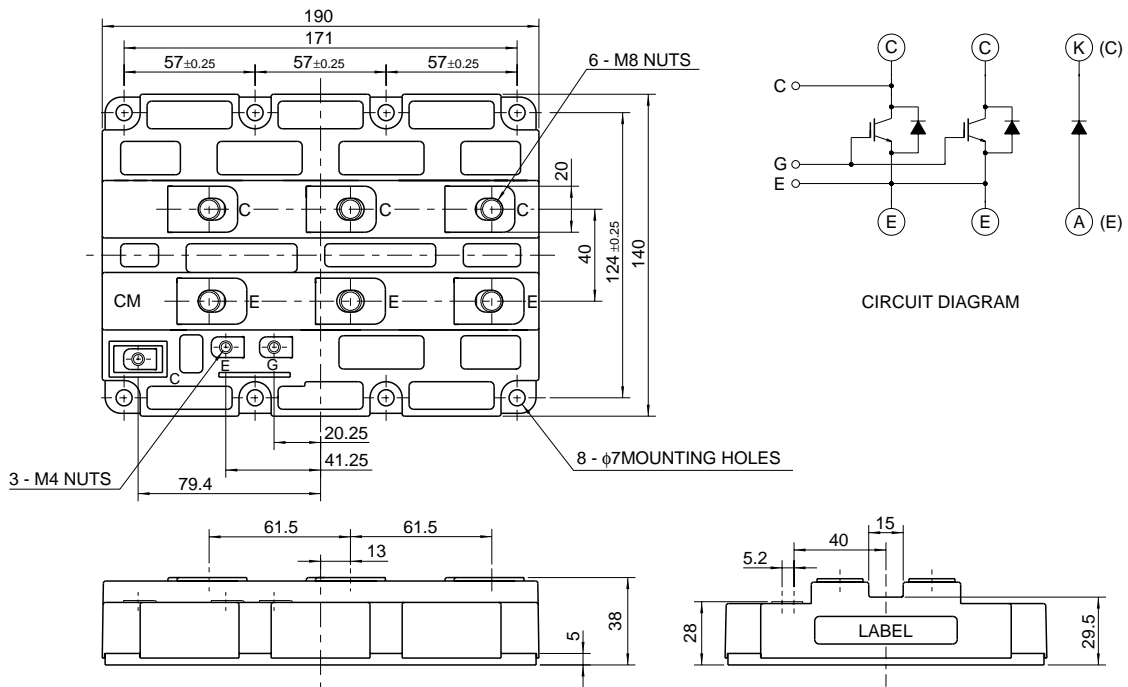

HVIGBT MODULES (High Voltage Insulated Gate Bipolar Transistor Modules)

Mar. 2003

CM800E2Z-66H

**HIGH POWER SWITCHING USE
INSULATED TYPE**

2nd-Version HVIGBT (High Voltage Insulated Gate Bipolar Transistor) Modules

MAXIMUM RATINGS (T_j = 25°C)

Symbol	Item	Conditions	Ratings	Unit
V _{CES}	Collector-emitter voltage	V _{GE} = 0V	3300	V
V _{GES}	Gate-emitter voltage	V _{CE} = 0V	±20	V
I _C	Collector current	DC, T _C = 100°C	800	A
I _{CM}		Pulse (Note 1)	1600	A
I _E (Note 2)	Emitter current		800	A
I _{EM} (Note 2)		Pulse (Note 1)	1600	A
P _C (Note 3)	Maximum collector dissipation	T _C = 25°C, IGBT part	10400	W
T _j	Junction temperature	—	-40 ~ +150	°C
T _{stg}	Storage temperature	—	-40 ~ +125	°C
V _{iso}	Isolation voltage	Charged part to base plate, rms, sinusoidal, AC 60Hz 1min.	6000	V
—	Mounting torque	Main terminals screw M8	6.67 ~ 13.00	N·m
		Mounting screw M6	2.84 ~ 6.00	N·m
		Auxiliary terminals screw M4	0.88 ~ 2.00	N·m
—	Mass	Typical value	2.2	kg

ELECTRICAL CHARACTERISTICS (T_j = 25°C)

Symbol	Item	Conditions	Limits			Unit
			Min	Typ	Max	
I _{CES}	Collector cutoff current	V _{CE} = V _{CES} , V _{GE} = 0V	—	—	10	mA
V _{GE(th)}	Gate-emitter threshold voltage	I _C = 80mA, V _{CE} = 10V	4.5	6.0	7.5	V
I _{GES}	Gate-leakage current	V _{GE} = V _{GES} , V _{CE} = 0V	—	—	0.5	µA
V _{CE(sat)}	Collector-emitter saturation voltage	T _j = 25°C	—	3.80	4.94	V
		T _j = 125°C	—	4.00	—	
C _{ies}	Input capacitance	V _{CE} = 10V V _{GE} = 0V	—	120	—	nF
C _{oes}	Output capacitance		—	12.0	—	nF
C _{res}	Reverse transfer capacitance		—	3.6	—	nF
Q _G	Total gate charge	V _{CC} = 1650V, I _C = 800A, V _{GE} = 15V	—	5.7	—	µC
t _{d(on)}	Turn-on delay time	V _{CC} = 1650V, I _C = 800A	—	—	1.60	µs
t _r	Turn-on rise time	V _{GE1} = V _{GE2} = 15V	—	—	2.00	µs
t _{d(off)}	Turn-off delay time	R _G = 2.5Ω	—	—	2.50	µs
t _f	Turn-off fall time	Resistive load switching operation	—	—	1.00	µs
V _{EC} (Note 2)	Emitter-collector voltage	I _E = 800A, V _{GE} = 0V	—	2.80	3.64	V
t _{rr} (Note 2)	Reverse recovery time	I _E = 800A	—	—	1.40	µs
Q _{rr} (Note 2)	Reverse recovery charge	die / dt = -1600A / µs	—	270	—	µC
R _{th(j-c)Q}	Thermal resistance	Junction to case, IGBT part	—	—	0.012	K/W
R _{th(j-c)R}		Junction to case, FWDi part	—	—	0.024	K/W
R _{th(c-f)}	Contact thermal resistance	Case to fin, conductive grease applied (Per 2/3 module)	—	0.008	—	K/W
V _{FM}	Forward voltage	I _F = 800A, Clamp diode part	—	3.00	3.90	V
t _{rr}	Reverse recovery time	I _F = 800A	—	—	1.40	µs
Q _{rr}	Reverse recovery charge	die / dt = -1600A / µs, Clamp diode part	—	270	—	µC
R _{th(j-c)}	Thermal resistance	Junction to case, Clamp diode part	—	—	0.024	K/W
R _{th(c-f)}	Contact thermal resistance	Case to fin, conductive grease applied (Per 1/3 module)	—	0.008	—	K/W

- Note 1. Pulse width and repetition rate should be such that the device junction temp. (T_j) does not exceed T_{jmax} rating.
 2. I_E, V_{EC}, t_{rr}, Q_{rr} & die/dt represent characteristics of the anti-parallel, emitter to collector free-wheel diode.
 3. Junction temperature (T_j) should not increase beyond 150°C.
 4. Pulse width and repetition rate should be such as to cause negligible temperature rise.

CM800E2Z-66H

HIGH POWER SWITCHING USE
INSULATED TYPE

2nd-Version HVIGBT (High Voltage Insulated Gate Bipolar Transistor) Modules

PERFORMANCE CURVES

OUTPUT CHARACTERISTICS
(TYPICAL)

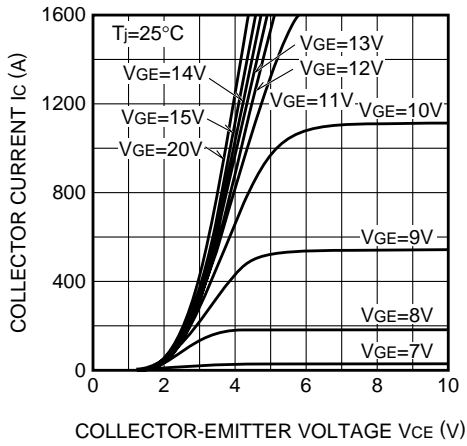

TRANSFER CHARACTERISTICS
(TYPICAL)

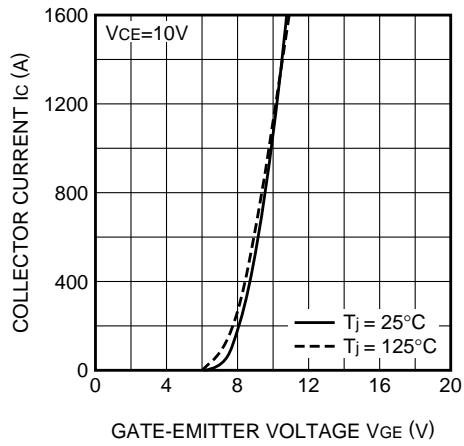

COLLECTOR-EMITTER SATURATION
VOLTAGE CHARACTERISTICS
(TYPICAL)

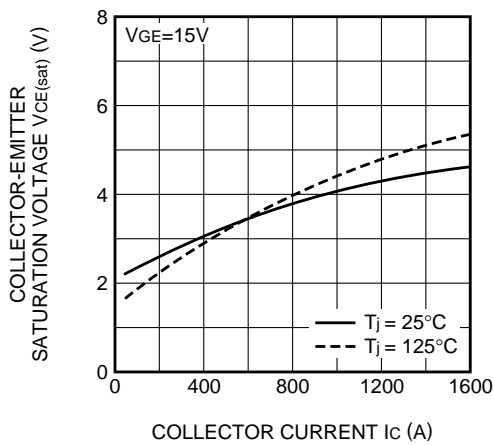

COLLECTOR-EMITTER SATURATION
VOLTAGE CHARACTERISTICS
(TYPICAL)

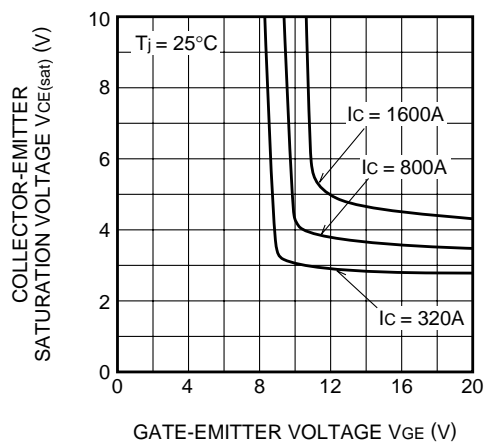

FREE-WHEEL DIODE
FORWARD CHARACTERISTICS
(TYPICAL)

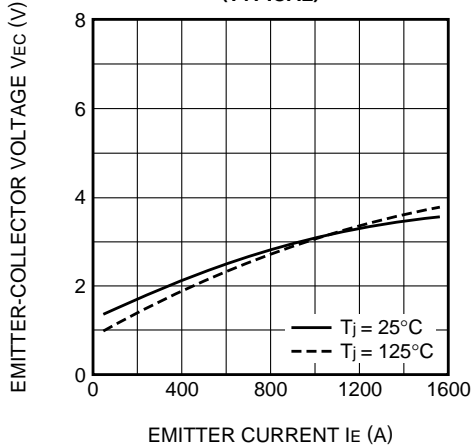

CAPACITANCE CHARACTERISTICS
(TYPICAL)

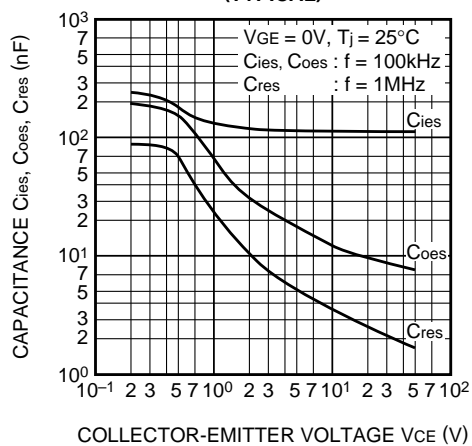

CM800E2Z-66H

HIGH POWER SWITCHING USE
INSULATED TYPE

2nd-Version HVIGBT (High Voltage Insulated Gate Bipolar Transistor) Modules

