

MITSUBISHI IGBT MODULES
CM100DU-12F

HIGH POWER SWITCHING USE

CM100DU-12F



- IC 100A
- VCES 600V
- Insulated Type
- 2-elements in a pack

APPLICATION

General purpose inverters & Servo controls, etc

OUTLINE DRAWING & CIRCUIT DIAGRAM

Dimensions in mm

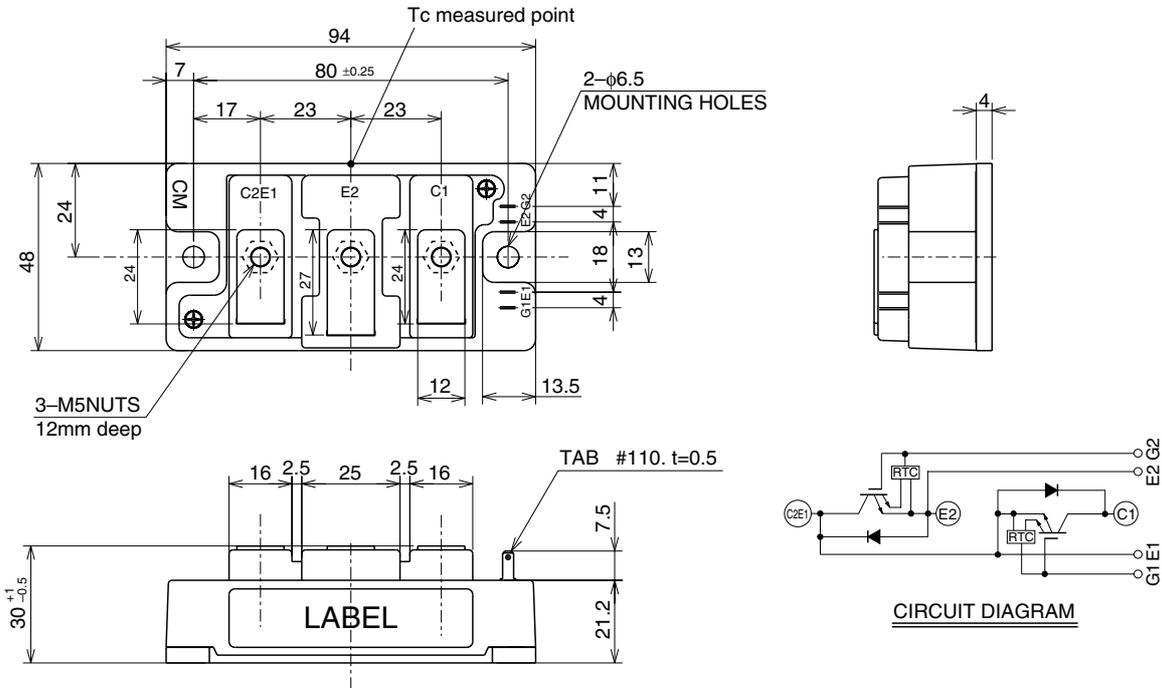

CM100DU-12F

HIGH POWER SWITCHING USE

MAXIMUM RATINGS (T_J = 25°C, unless otherwise specified)

| Symbol | Parameter | Conditions | Ratings | Unit |
|--------------------------|-------------------------------|---|------------|------------------|
| V _{CE} S | Collector-emitter voltage | G-E Short | 600 | V |
| V _{GE} S | Gate-emitter voltage | C-E Short | ±20 | V |
| I _C | Collector current | T _C = 25°C | 100 | A |
| I _{CM} | | Pulse (Note 2) | 200 | A |
| I _E (Note 1) | Emitter current | T _C = 25°C | 100 | A |
| I _{EM} (Note 1) | | Pulse (Note 2) | 200 | A |
| P _C (Note 3) | Maximum collector dissipation | T _C = 25°C | 350 | W |
| T _J | Junction temperature | | -40 ~ +150 | °C |
| T _{stg} | Storage temperature | | -40 ~ +125 | °C |
| V _{iso} | Isolation voltage | Charged part to base plate, f = 60Hz, AC 1 minute | 2500 | V _{rms} |
| — | Torque strength | Main terminals M5 screw | 2.5 ~ 3.5 | N • m |
| | | Mounting M6 screw | 3.5 ~ 4.5 | N • m |
| — | Weight | Typical value | 310 | g |

ELECTRICAL CHARACTERISTICS (T_J = 25°C, unless otherwise specified)

| Symbol | Parameter | Test conditions | Limits | | | Unit |
|--------------------------|--------------------------------------|---|------------------------|------|--------|------|
| | | | Min. | Typ. | Max. | |
| I _{CE} S | Collector cutoff current | V _{CE} = V _{CE} S, V _{GE} = 0V | — | — | 1 | mA |
| V _{GE(th)} | Gate-emitter threshold voltage | I _C = 10mA, V _{CE} = 10V | 5 | 6 | 7 | V |
| I _{GE} S | Gate leakage current | ±V _{GE} = V _{GE} S, V _{CE} = 0V | — | — | 20 | μA |
| V _{CE(sat)} | Collector-emitter saturation voltage | I _C = 100A, V _{GE} = 15V | T _J = 25°C | | 2.2 | V |
| | | | T _J = 125°C | | — | |
| C _{ies} | Input capacitance | V _{CE} = 10V V _{GE} = 0V | — | — | 27 | nF |
| C _{oes} | Output capacitance | | — | — | 1.8 | nF |
| C _{res} | Reverse transfer capacitance | | — | — | 1 | nF |
| Q _G | Total gate charge | V _{CC} = 300V, I _C = 100A, V _{GE} = 15V | — | 620 | — | nC |
| t _{d(on)} | Turn-on delay time | V _{CC} = 300V, I _C = 100A V _{GE} = ±15V R _G = 6.3Ω, Inductive load I _E = 100A | — | — | 100 | ns |
| t _r | Turn-on rise time | | — | — | 80 | ns |
| t _{d(off)} | Turn-off delay time | | — | — | 300 | ns |
| t _f | Turn-off fall time | | — | — | 250 | ns |
| t _{rr} (Note 1) | Reverse recovery time | | — | — | 150 | ns |
| Q _{rr} (Note 1) | Reverse recovery charge | | — | 1.9 | — | μC |
| V _{EC} (Note 1) | Emitter-collector voltage | I _E = 100A, V _{GE} = 0V | — | — | 2.6 | V |
| R _{th(j-c)Q} | Thermal resistance *1 | IGBT part (1/2 module) | — | — | 0.35 | K/W |
| R _{th(j-c)R} | | FWDi part (1/2 module) | — | — | 0.70 | K/W |
| R _{th(c-f)} | Contact thermal resistance | Case to heat sink, Thermal compound applied*2 (1/2 module) | — | 0.07 | — | K/W |
| R _{th(j-c)Q} | Thermal resistance | Case temperature measured point is just under the chips | — | — | 0.28*3 | K/W |
| R _G | External gate resistance | | 6.3 | — | 63 | Ω |

Note 1. I_E, V_{EC}, t_{rr}, Q_{rr} & die/dt represent characteristics of the anti-parallel, emitter-collector free-wheel diode (FWDi).
 2. Pulse width and repetition rate should be such that the device junction temperature (T_J) does not exceed T_{Jmax} rating.
 3. Junction temperature (T_J) should not increase beyond 150°C.
 *1 : Case temperature (T_C) measured point is indicated in OUTLINE DRAWING.
 *2 : Typical value is measured by using thermally conductive grease of λ = 0.9[W/(m • K)].
 *3 : If you use this value, R_{th(f-a)} should be measured just under the chips.

PERFORMANCE CURVES

OUTPUT CHARACTERISTICS (TYPICAL)

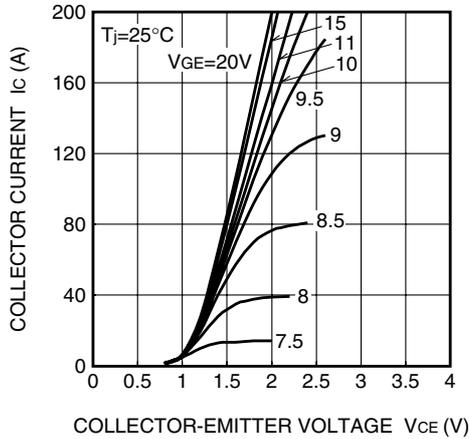

COLLECTOR-EMITTER SATURATION VOLTAGE CHARACTERISTICS (TYPICAL)

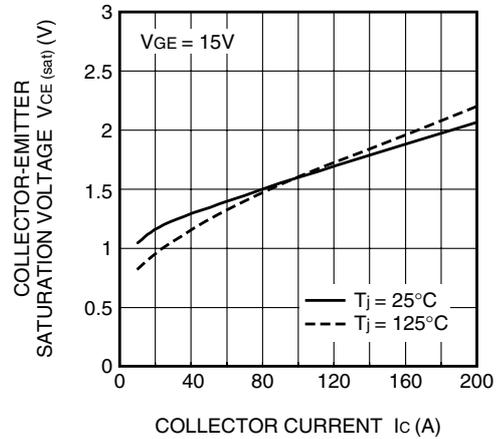

COLLECTOR-EMITTER SATURATION VOLTAGE CHARACTERISTICS (TYPICAL)

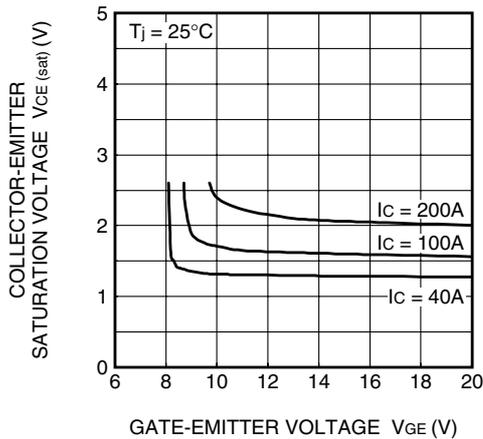

FREE-WHEEL DIODE FORWARD CHARACTERISTICS (TYPICAL)

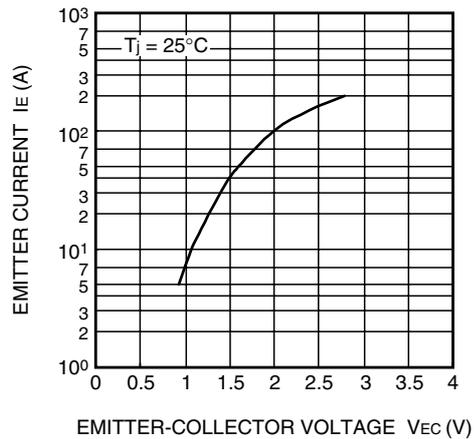

CAPACITANCE-Vce CHARACTERISTICS (TYPICAL)

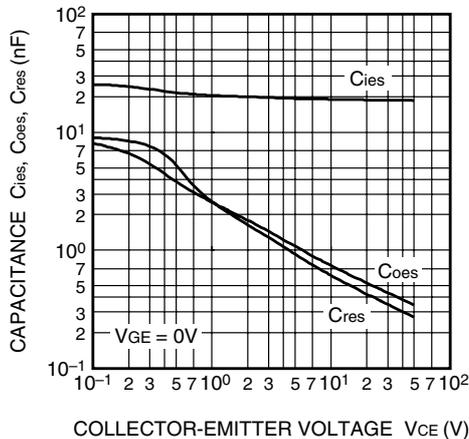

HALF-BRIDGE SWITCHING CHARACTERISTICS (TYPICAL)

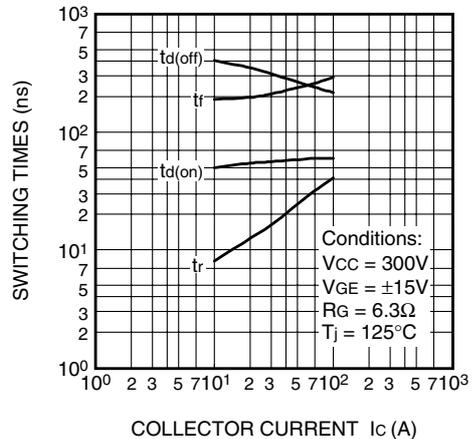

REVERSE RECOVERY CHARACTERISTICS OF FREE-WHEEL DIODE (TYPICAL)

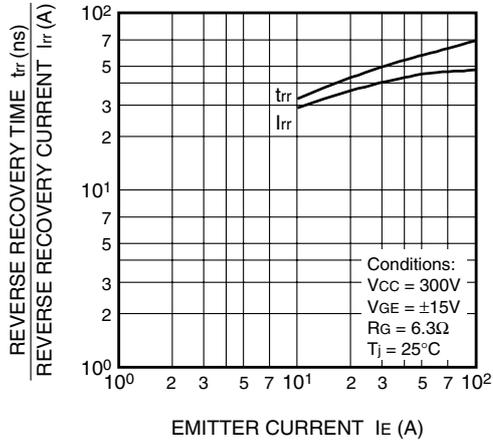

TRANSIENT THERMAL IMPEDANCE CHARACTERISTICS (IGBT part & FWDi part)

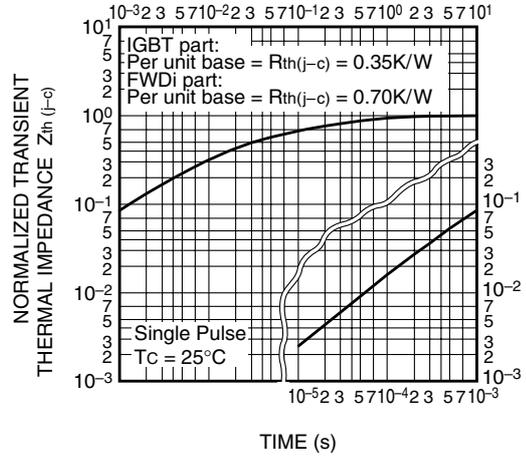

GATE CHARGE CHARACTERISTICS (TYPICAL)

