

## Not for new designs

Low  $V_{CE(sat)}$  IGBT with Diode  
High Speed IGBT with Diode

IXSH 20 N60U1  
IXSH 20 N60AU1

$V_{CES}$	$I_{C25}$	$V_{CE(sat)}$
600 V	40 A	2.5 V
600 V	40 A	3.0 V

## Combi Packs

### Short Circuit SOA Capability

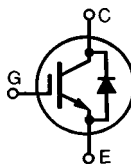

Symbol	Test Conditions	Maximum Ratings	
$V_{CES}$	$T_J = 25^\circ\text{C}$ to $150^\circ\text{C}$	600	V
$V_{CGR}$	$T_J = 25^\circ\text{C}$ to $150^\circ\text{C}$ ; $R_{GE} = 1\text{ M}\Omega$	600	V
$V_{GES}$	Continuous	$\pm 20$	V
$V_{GEM}$	Transient	$\pm 30$	V
$I_{C25}$	$T_C = 25^\circ\text{C}$	40	A
$I_{C90}$	$T_C = 90^\circ\text{C}$	20	A
$I_{CM}$	$T_C = 25^\circ\text{C}$ , 1 ms	80	A
<b>SSOA (RBSOA)</b>	$V_{GE} = 15\text{ V}$ , $T_J = 125^\circ\text{C}$ , $R_G = 82\ \Omega$ Clamped inductive load, $L = 100\ \mu\text{H}$	$I_{CM} = 40$ @ $0.8 V_{CES}$	A
<b><math>t_{SC}</math> (SCSOA)</b>	$V_{GE} = 15\text{ V}$ , $V_{CE} = 360\text{ V}$ , $T_J = 125^\circ\text{C}$ $R_G = 82\ \Omega$ , non repetitive	10	$\mu\text{s}$
$P_C$	$T_C = 25^\circ\text{C}$	150	W
$T_J$		-55 ... +150	$^\circ\text{C}$
$T_{JM}$		150	$^\circ\text{C}$
$T_{stg}$		-55 ... +150	$^\circ\text{C}$
$M_d$	Mounting torque	1.13/10	Nm/lb.in.
<b>Weight</b>		6	g
Maximum lead temperature for soldering 1.6 mm (0.062 in.) from case for 10 s		300	$^\circ\text{C}$

### TO-247 AD

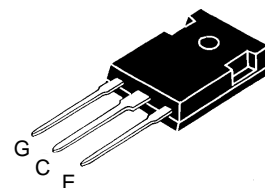

G = Gate,                      C = Collector,  
E = Emitter,                TAB = Collector

### Features

- International standard package JEDEC TO-247 AD
- High frequency IGBT with guaranteed Short Circuit SOA capability
- IGBT and anti-parallel FRED in one package
- 2nd generation HDMOS™ process
- Low  $V_{CE(sat)}$ 
  - for low on-state conduction losses
- MOS Gate turn-on
  - drive simplicity

### Applications

- AC motor speed control
- DC servo and robot drives
- DC choppers
- Uninterruptible power supplies (UPS)
- Switch-mode and resonant-mode power supplies

### Advantages

- Space savings (two devices in one package)
- Easy to mount with 1 screw (isolated mounting screw hole)
- Reduces assembly time and cost
- High power density

Symbol	Test Conditions	Characteristic Values ( $T_J = 25^\circ\text{C}$ , unless otherwise specified)		
		min.	typ.	max.
$BV_{CES}$	$I_C = 1.75\text{ mA}$ , $V_{GE} = 0\text{ V}$	600		V
$V_{GE(th)}$	$I_C = 1.5\text{ mA}$ , $V_{CE} = V_{GE}$	3.5		V
$I_{CES}$	$V_{CE} = 0.8 \cdot V_{CES}$ , $T_J = 25^\circ\text{C}$ $V_{GE} = 0\text{ V}$ , $T_J = 125^\circ\text{C}$			500 $\mu\text{A}$ 8 mA
$I_{GES}$	$V_{CE} = 0\text{ V}$ , $V_{GE} = \pm 20\text{ V}$			$\pm 100\text{ nA}$
$V_{CE(sat)}$	$I_C = I_{C90}$ , $V_{GE} = 15\text{ V}$			2.5 V 3.0 V
				20N60U1 20N60AU1

Symbol	Test Conditions	Characteristic Values ( $T_J = 25^\circ\text{C}$ , unless otherwise specified)		
		min.	typ.	max.
$g_{fs}$	$I_C = I_{C90}$ ; $V_{CE} = 10\text{ V}$ , Pulse test, $t \leq 300\ \mu\text{s}$ , duty cycle $\leq 2\%$	6	7	S
$I_{C(on)}$	$V_{GE} = 15\text{ V}$ , $V_{CE} = 10\text{ V}$		65	A
$C_{ies}$	$V_{CE} = 25\text{ V}$ , $V_{GE} = 0\text{ V}$ , $f = 1\text{ MHz}$		1800	pF
$C_{oes}$			250	pF
$C_{res}$			45	pF
$Q_g$	$I_C = I_{C90}$ , $V_{GE} = 15\text{ V}$ , $V_{CE} = 0.5 V_{CES}$		90	nC
$Q_{ge}$			40	nC
$Q_{gc}$			65	nC
$t_{d(on)}$	<b>Inductive load, <math>T_J = 25^\circ\text{C}</math></b> $I_C = I_{C90}$ , $V_{GE} = 15\text{ V}$ , $L = 100\ \mu\text{H}$ , $V_{CE} = 0.8 V_{CES}$ , $R_G = 39\ \Omega$ Remarks: Switching times may increase for $V_{CE}$ (Clamp) > $0.8 \cdot V_{CES}$ , higher $T_J$ or increased $R_G$		100	ns
$t_{ri}$			200	ns
$t_{d(off)}$			450	ns
$t_{fi}$		20N60U1		ns
$E_{off}$		20N60AU1	350	ns
$t_{d(on)}$	<b>Inductive load, <math>T_J = 125^\circ\text{C}</math></b> $I_C = I_{C90}$ , $V_{GE} = 15\text{ V}$ , $L = 100\ \mu\text{H}$ $V_{CE} = 0.8 V_{CES}$ , $R_G = 39\ \Omega$ Remarks: Switching times may increase for $V_{CE}$ (Clamp) > $0.8 \cdot V_{CES}$ , higher $T_J$ or increased $R_G$		100	ns
$t_{ri}$			200	ns
$E_{on}$			1	mJ
$t_{d(off)}$		20N60U1		1000 ns
$t_{fi}$		20N60AU1		600 ns
$E_{off}$	20N60U1	9	mJ	
	20N60AU1	3	5 mJ	
$R_{thJC}$			0.83	K/W
$R_{thCK}$			0.25	K/W

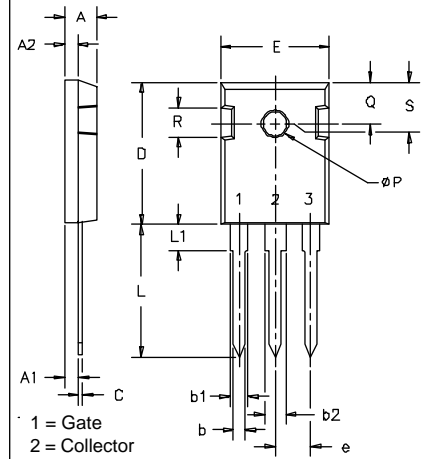
**TO-247 AD Outline**

- 1 = Gate
- 2 = Collector
- 3 = Emitter
- Tab = Collector

SYM	INCHES		MILLIMETERS	
	MIN	MAX	MIN	MAX
A	.185	.209	4.7	5.3
A1	.087	.102	2.2	2.54
A2	.059	.098	2.2	2.6
b	.040	.055	1.0	1.4
b1	.065	.084	1.65	2.13
b2	.113	.123	2.87	3.12
C	.016	.031	.4	.8
D	.819	.845	20.80	21.46
E	.610	.640	15.75	16.26
e	.215 BSC		5.45 BSC	
L	.780	.800	19.81	20.32
L1		.177		4.50
$\phi P$	.140	.144	3.55	3.65
Q	.212	.244	5.4	6.2
R	.170	.216	4.32	5.49
S	.242 BSC		6.15 BSC	

Symbol	Test Conditions	Characteristic Values ( $T_J = 25^\circ\text{C}$ , unless otherwise specified)		
		min.	typ.	max.
$V_F$	$I_F = I_{C90}$ , $V_{GE} = 0\text{ V}$ , Pulse test, $t \leq 300\ \mu\text{s}$ , duty cycle $d \leq 2\%$			1.6 V
$I_{RM}$	$I_F = I_{C90}$ , $V_{GE} = 0\text{ V}$ , $-di_F/dt = 240\text{ A}/\mu\text{s}$ $V_R = 360\text{ V}$ , $T_J = 125^\circ\text{C}$ $I_F = 1\text{ A}$ ; $-di/dt = 100\text{ A}/\mu\text{s}$ ; $V_R = 30\text{ V}$ , $T_J = 25^\circ\text{C}$		10	A
$t_{rr}$			150	ns
			35	50 ns
$R_{thJC}$				1 K/W

**Fig. 1 Saturation Characteristics**

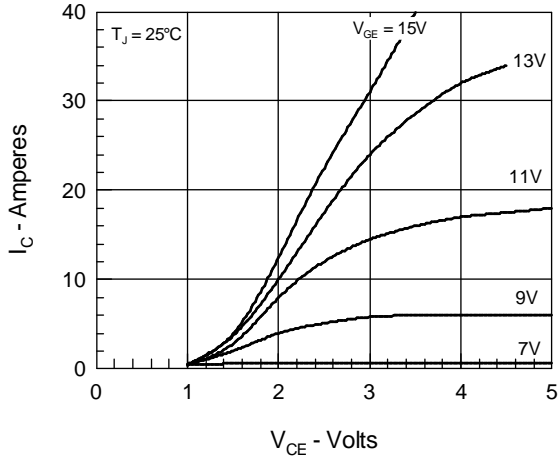

**Fig. 2 Output Characteristics**

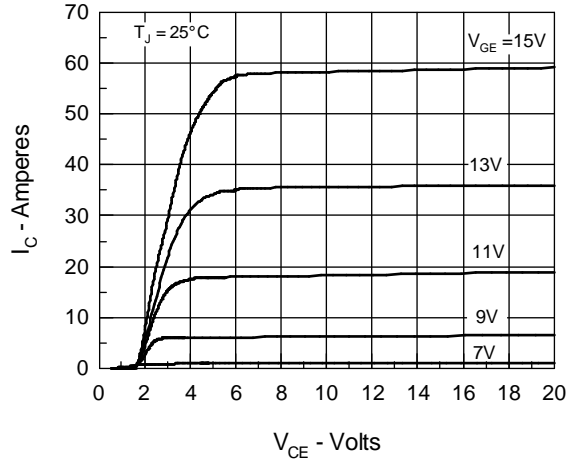

**Fig. 3 Collector-Emitter Voltage vs. Gate-Emitter Voltage**

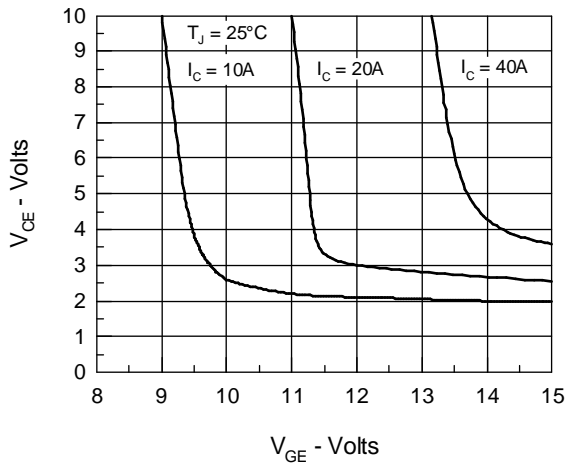

**Fig. 4 Temperature Dependence of Output Saturation Voltage**

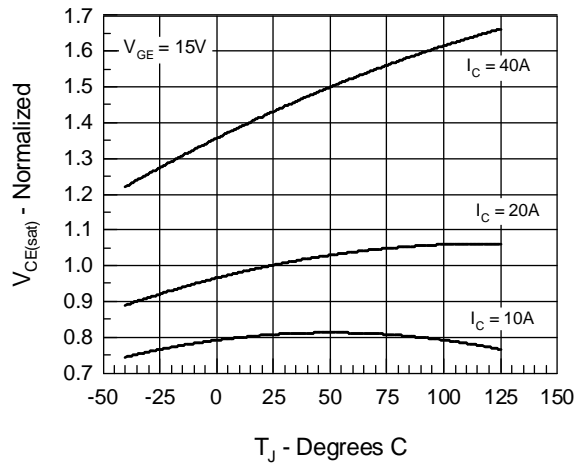

**Fig. 5 Input Admittance**

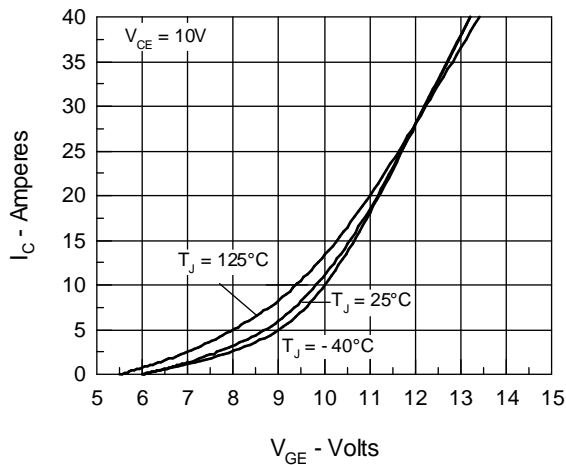

**Fig. 6 Temperature Dependence of Breakdown and Threshold Volt.**

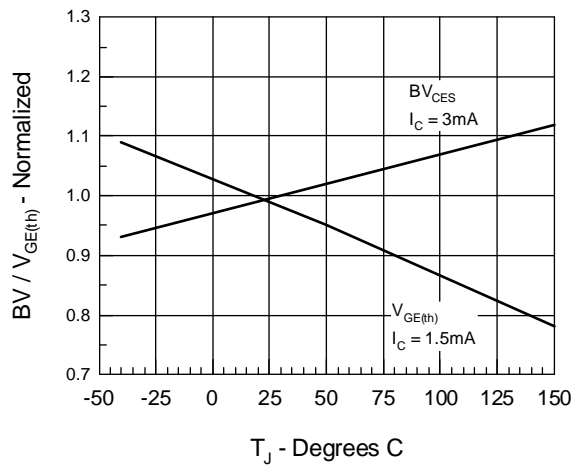

Fig.7 Turn-Off Energy per Pulse and Fall Time on Collector Current

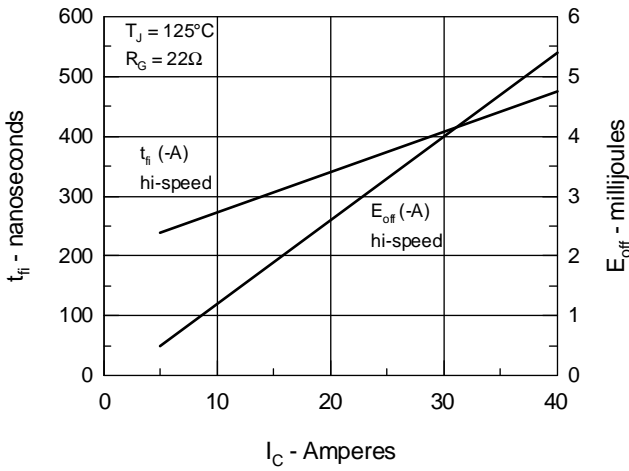

Fig.8 Dependence of Turn-Off Energy Per Pulse and Fall Time on  $R_G$

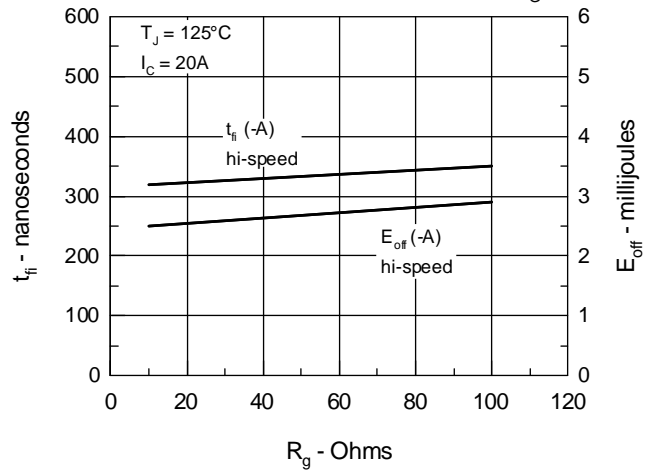

Fig.9 Gate Charge Characteristic Curve

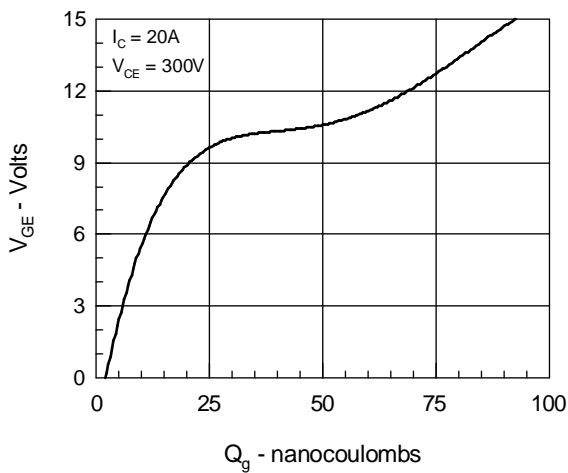

Fig.10 Turn-Off Safe Operating Area

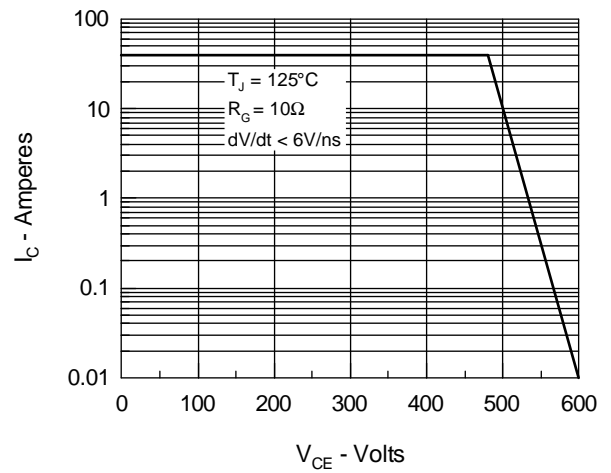

Fig.11 Transient Thermal Impedance

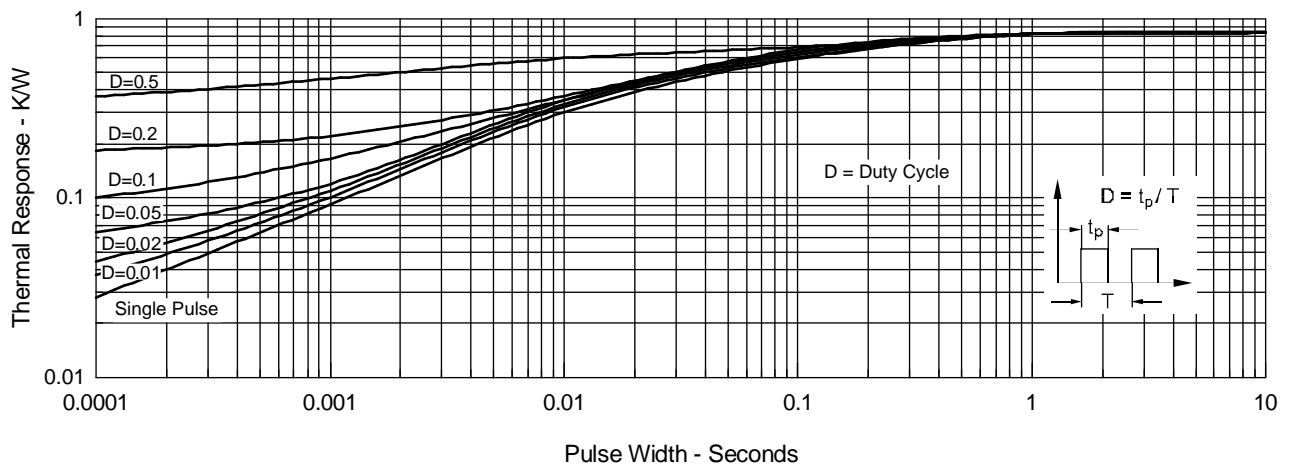

Fig.12 Maximum Forward Voltage Drop

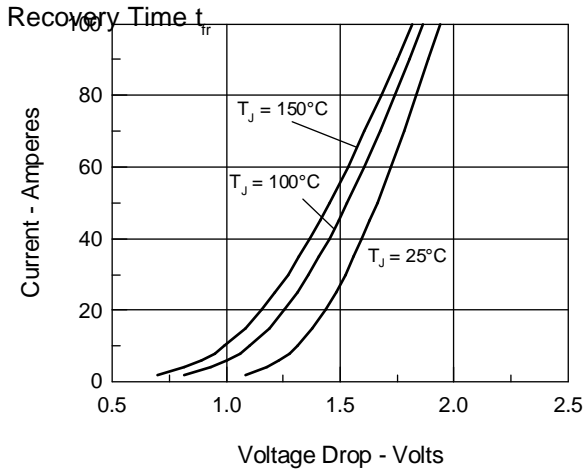

Fig.13 Peak Forward Voltage  $V_{FR}$  and Forward Recovery Time  $t_{fr}$

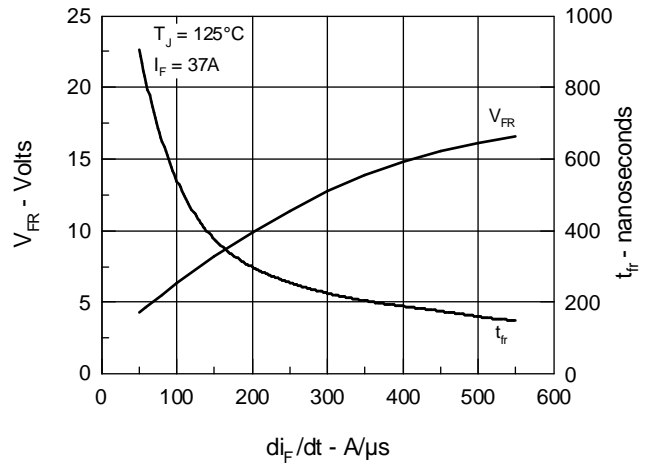

Fig.14 Junction Temperature Dependence of  $I_{RM}$  and  $Q_r$

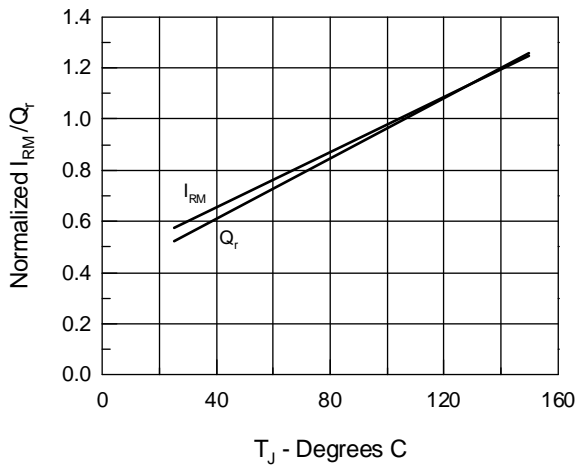

Fig.15 Reverse Recovery Charge

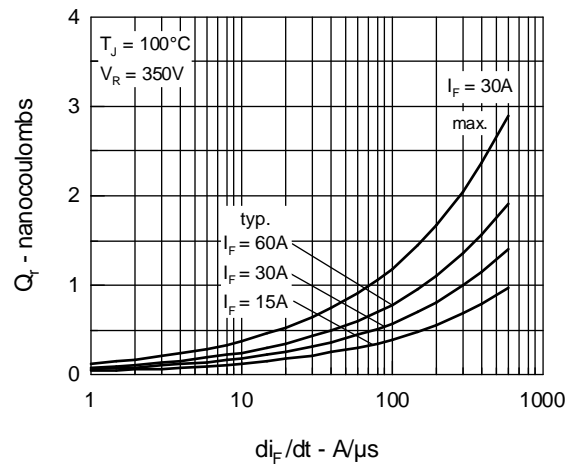

Fig.16 Peak Reverse Recovery Current

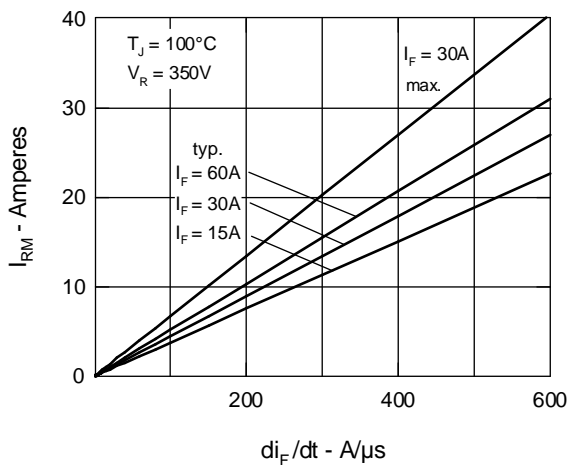

Fig.17 Reverse Recovery Time

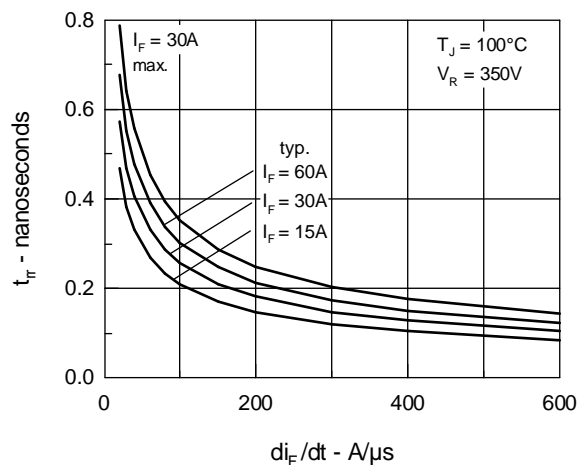

Fig.18 Diode Transient Thermal resistance junction to case

