

#### 1 Description

These N-Channel enhancement mode power field effect transistors are produced using planar stripe, DMOS technology.

This advanced technology has been especially tailored to minimize on-state resistance, provide superior switching performance, and withstand high energy pulse in the avalanche and commutation mode. These devices are well suited for high efficiency switched mode power supplies, active power factor correction based on half bridge topology.

#### 2 Features

- 500V / 4.5A
- $R_{DS(on)} = 1.2\Omega(\text{typ})$ ,  $V_{GS} = 10V$ ,  $I_D = 2.7A$
- Fast switching
- 100% avalanche tested
- Improved dv/dt capability..

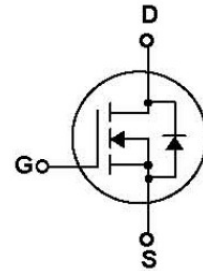
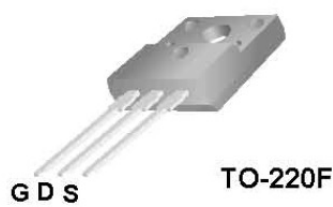
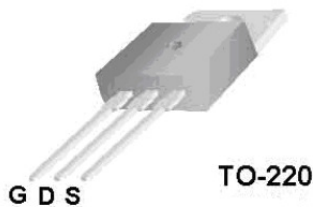

#### 3 Absolute Maximum Ratings $T_C = 25^\circ\text{C}$ unless otherwise noted

Symbol	Parameter	APQ4ESN50AH-XXM0	APQ4ESN50AF-XXM0	Units
		APQ4ESN50AH-XXJ0	APQ4ESN50AF-XXJ0	
		TO-220	TO-220F	
$V_{DSS}$	Drain-Source Voltage	500		V
$I_D$	Drain Current - Continuous ( $T_C = 25^\circ\text{C}$ ) - Continuous ( $T_C = 100^\circ\text{C}$ )	4.5		A
		2.7		A
$I_{DM}$	Drain Current – Pulsed ①	18		A
$V_{GS}$	Gate-Source Voltage	$\pm 30$		V
$E_{AS}$	Single Pulsed Avalanche Energy ②	280		mJ
$I_{AR}$	Avalanche Current	3.5		A
$E_{AR}$	Repetitive Avalanche Energy	7.4		mJ
dv/dt	Peak Diode Recovery dv/dt ③	3.5		V/ns
$P_D$	Power Dissipation ( $T_C = 25^\circ\text{C}$ ) - De-rate above $25^\circ\text{C}$	74	38	W
		0.58	0.3	W/ $^\circ\text{C}$
$T_J, T_{STG}$	Operating and Storage Temperature Range	-55 to +150		$^\circ\text{C}$
$T_L$	Maximum lead temperature for soldering purposes, 1/8" from case for 5 seconds	300		$^\circ\text{C}$

\* note :

- ① Repetitive Rating: Pulse width limited by maximum junction temperature.
- ②  $V_{DD} = 50V$ , starting  $T_J = 25^\circ\text{C}$ ,  $L = 24\text{mH}$ ,  $R_G = 25\Omega$ ,  $I_{AS} = 4.5A$
- ③  $I_{SD} \leq 4.5A$ ,  $di/dt \leq 100A/\mu\text{s}$ ,  $V_{DD} \leq V_{(BR)DSS}$ ,  $T_J \leq 150^\circ\text{C}$ .



4 Thermal Characteristics

Symbol	Parameter	APQ4ESN50AH-XXM0	APQ4ESN50AF-XXM0	Units
		APQ4ESN50AH-XXJ0	APQ4ESN50AF-XXJ0	
		TO-220	TO-220F	
$R_{\theta JC}$	Thermal Resistance, Junction-to-Case	1.7	3.3	°C/W
$R_{\theta CS}$	Thermal Resistance, Case-to-Sink Typ.	0.5	--	°C/W
$R_{\theta JA}$	Thermal Resistance, Junction-to-Ambient	62.5	62.5	°C/W

5 Electrical Characteristics  $T_C = 25^\circ\text{C}$  unless otherwise noted

Symbol	Parameter	Test Conditions	Min	Typ	Max	Units
<b>Off Characteristics</b>						
$BV_{DSS}$	Drain-Source Breakdown Voltage	$V_{GS} = 0\text{ V}, I_D = 250\ \mu\text{A}$	500	--	--	V
$\Delta BV_{DSS} / \Delta T_J$	Breakdown Voltage Temperature Coefficient	$I_D = 1\text{ mA}$ , Referenced to $25^\circ\text{C}$	--	0.61	--	V/°C
$I_{DSS}$	Gate to Source leakage current	$V_{DS} = 500\text{ V}, V_{GS} = 0\text{ V}$	--	--	20	$\mu\text{A}$
$I_{GSSF}$	Gate-Body Leakage Current, Forward	$V_{GS} = 30\text{ V}, V_{DS} = 0\text{ V}$	--	--	100	nA
$I_{GSSR}$	Gate-Body Leakage Current, Reverse	$V_{GS} = -30\text{ V}, V_{DS} = 0\text{ V}$	--	--	-100	nA
<b>On Characteristics</b>						
$V_{GS(th)}$	Gate Threshold Voltage	$V_{DS} = V_{GS}, I_D = 250\ \mu\text{A}$	2.0	--	4.0	V
$R_{DS(on)}$	Static Drain-Source On-Resistance	$V_{GS} = 10\text{ V}, I_D = 2.7\text{ A}$ ④	--	1.2	1.5	$\Omega$
$g_{FS}$	Forward Transconductance	$V_{DS} = 15\text{ V}, I_D = 2.25\text{ A}$ ①	--	--	10	S
<b>Dynamic Characteristics</b>						
$C_{iss}$	Input Capacitance	$V_{DS} = 25\text{ V}, V_{GS} = 0\text{ V}, f = 1.0\text{ MHz}$	--	610	--	pF
$C_{oss}$	Output Capacitance		--	160	--	pF
$C_{rss}$	Reverse Transfer Capacitance		--	68	--	pF
<b>Switching Characteristics</b>						
$t_{d(on)}$	Turn-On Delay Time	$V_{DD} = 300\text{ V}, I_D = 6\text{ A}, R_G = 25\ \Omega$ ④	--	8.2	--	ns
$t_r$	Turn-On Rise Time		--	16	--	ns
$t_{d(off)}$	Turn-Off Delay Time		--	42	--	ns
$t_f$	Turn-Off Fall Time		--	16	--	ns
$Q_g$	Total Gate Charge	$V_{DS} = 400\text{ V}, I_D = 3.1\text{ A}, V_{GS} = 10\text{ V}$ ④	--	--	38	nC
$Q_{gs}$	Gate-Source Charge		--	--	5	nC
$Q_{gd}$	Gate-Drain Charge		--	--	22	nC
<b>Drain-Source Diode Characteristics and Maximum Ratings</b>						
$I_S$	Maximum Continuous Drain-Source Diode Forward Current	--	--	4.5	--	A
$I_{SM}$	Maximum Pulsed Drain-Source Diode Forward Current	--	--	18	--	A

$V_{SD}$	Drain-Source Diode Forward Voltage	$V_{GS} = 0\text{ V}, I_S = 4.5\text{ A}$	--	--	1.6	V
$t_{rr}$	Reverse Recovery Time	$V_{GS} = 0\text{ V}, I_F = 3.1\text{ A},$ $di_F/dt = 100\text{ A}/\mu\text{s}$ ④	--	320	--	ns
$Q_{rr}$	Reverse Recovery Charge		--	1.0	--	$\mu\text{C}$

**Notes:**

- ① Repetitive Rating: Pulse width limited by maximum junction temperature.
- ②  $V_{DD} = 50\text{V}$ , starting  $T_J = 25^\circ\text{C}$ ,  $L = 24\text{mH}$ ,  $R_G = 25\Omega$ ,  $I_{AS} = 4.5\text{A}$
- ③  $I_{SD} \leq 4.5\text{A}$ ,  $di/dt \leq 75\text{A}/\mu\text{s}$ ,  $V_{DD} \leq V_{(BR)DSS}$ ,  $T_J \leq 150^\circ\text{C}$
- ④ Pulse Test: Pulse width  $\leq 300\mu\text{s}$ , Duty cycle  $\leq 2\%$ . Depend on FT Test.
- ⑤ CP Test

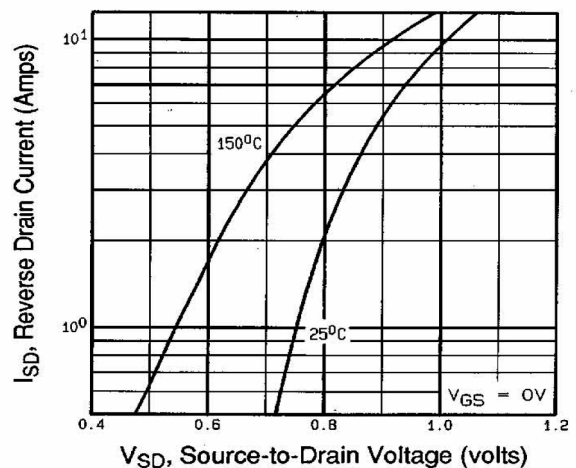
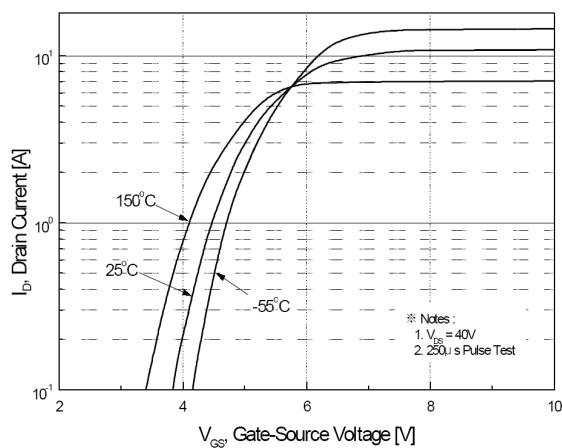
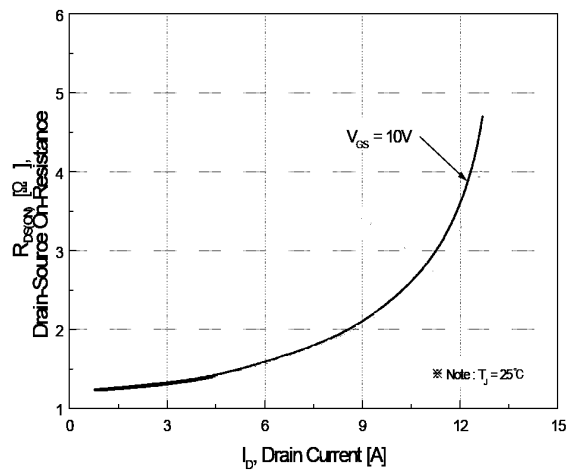
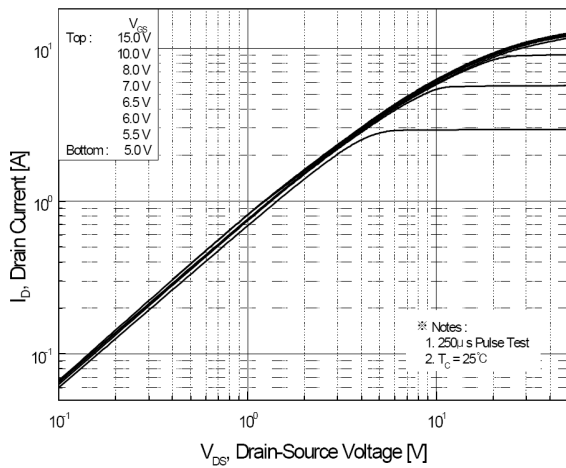

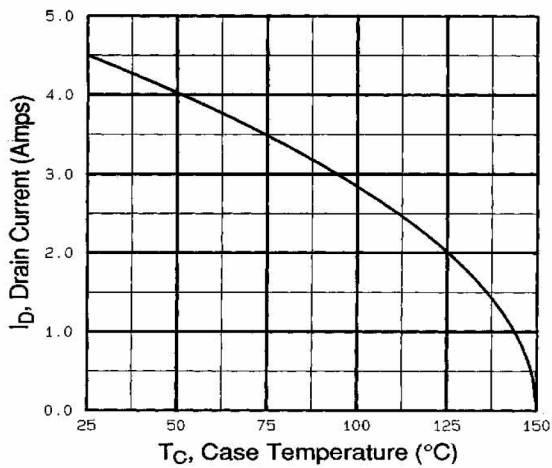
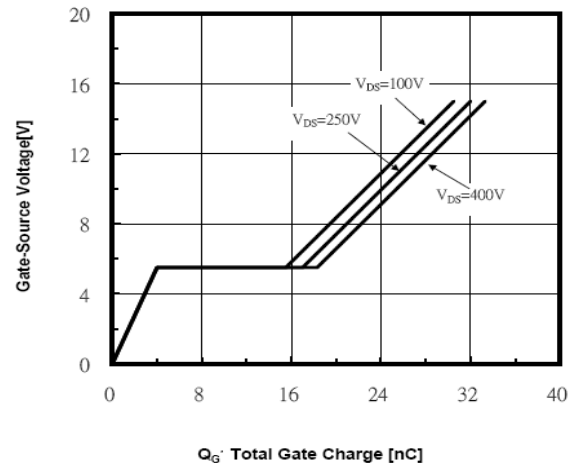
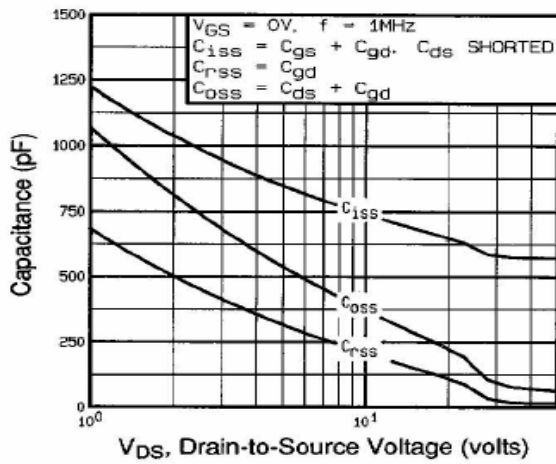
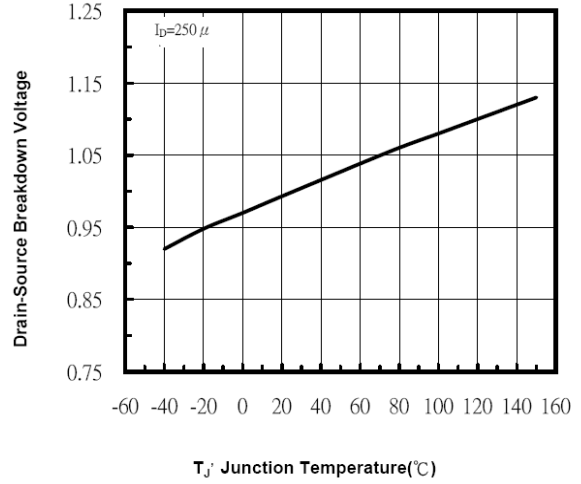
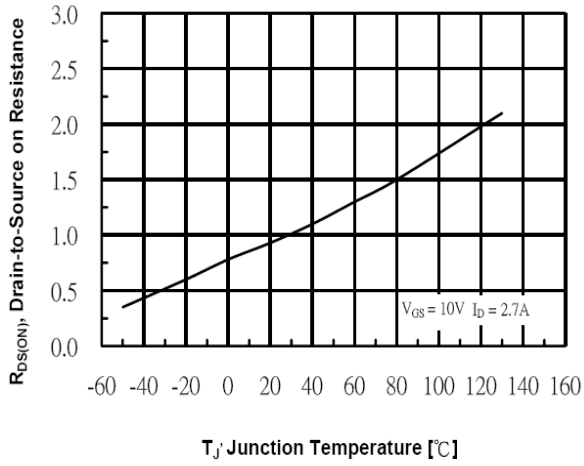

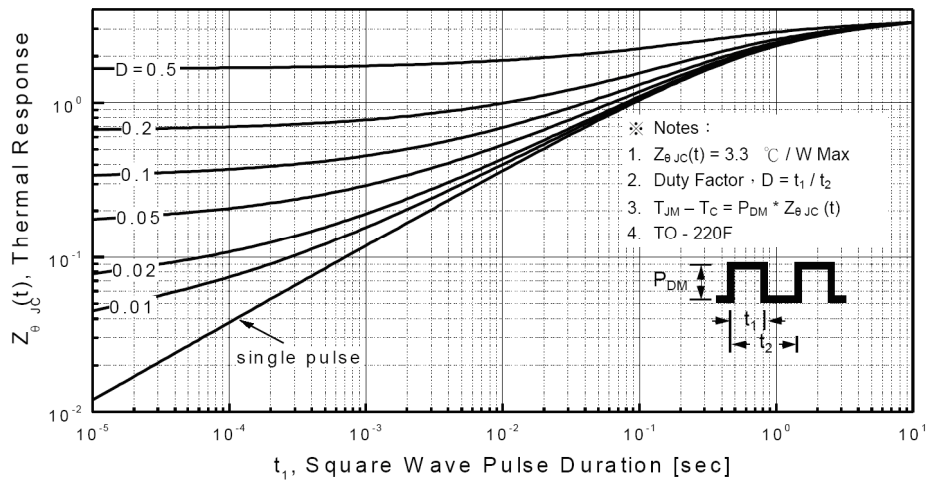
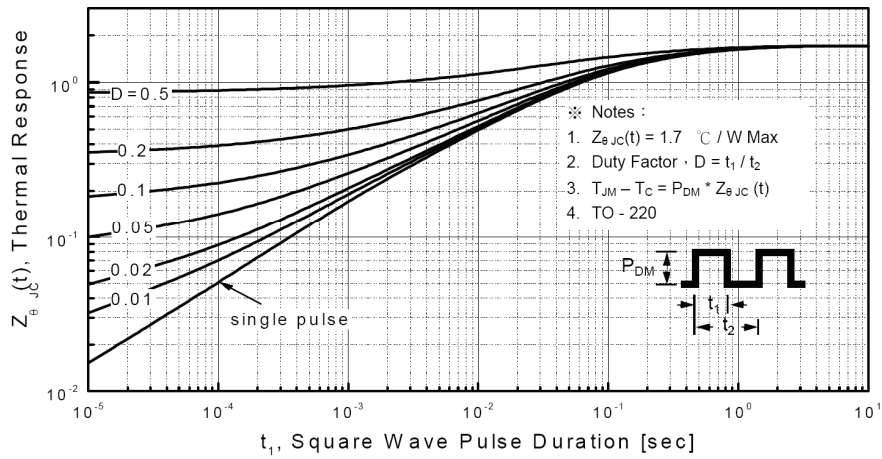
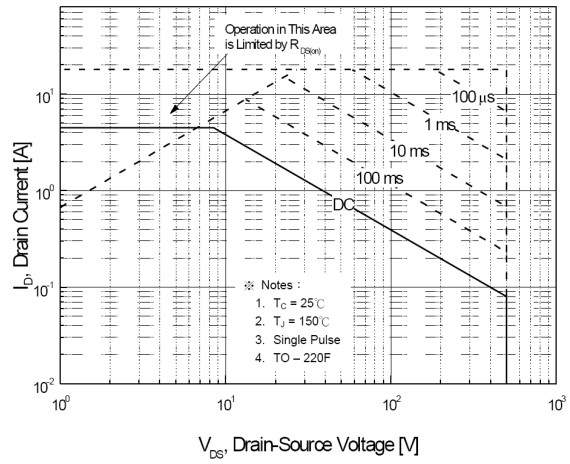
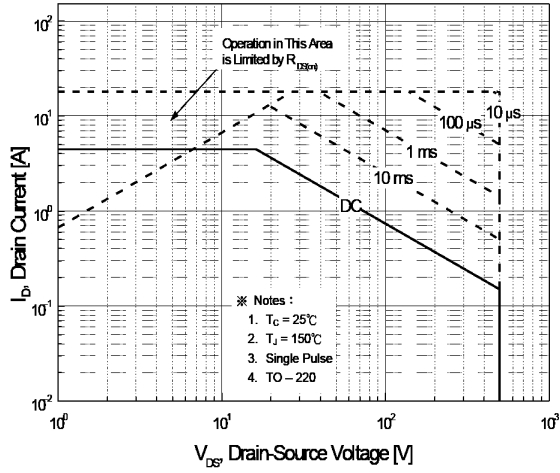

6 Package Dimensions

APQ4ESN50AH-XXM0  
TO-220

TO-220 DIMENSION			
DIM	MILLIMETERS		
	MIN	MAX	TYP.
A	10.04	10.41	10.23
B	3.66	3.88	3.77
C	2.50	2.84	2.67
D	3.31	4.50	3.91
E	0.70	0.91	0.81
F	2.54(typ.)		2.54
G	5.08(typ.)		5.08
H	13.47	14.20	13.84
I	8.50	9.00	8.80
J	14.80	15.49	15.15
K	4.32	4.57	4.45
L	1.22	1.42	1.30
M	28.27	29.69	28.98
N	2.40	2.90	2.65
O	0.36	0.53	0.45
P	5.97	6.47	6.22
Q	1.15	1.45	1.30

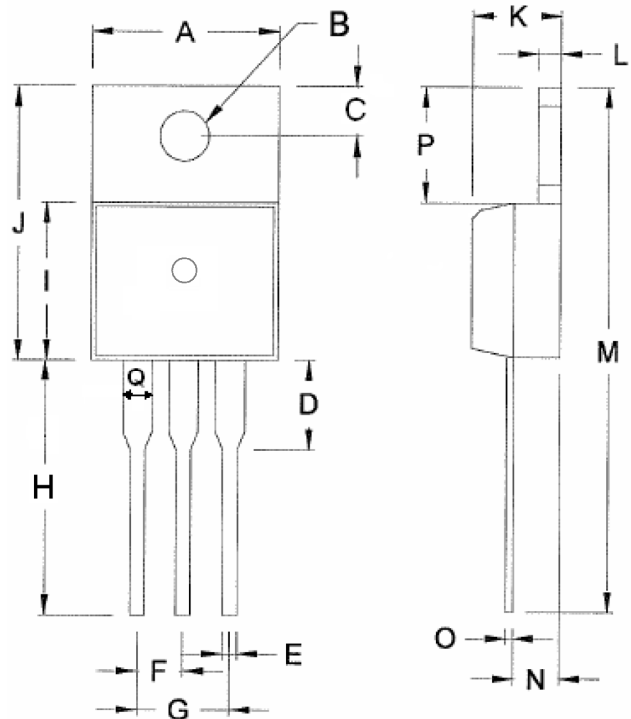

APQ4ESN50AH-XXJ0  
TO-220

TO-220 DIMENSION			
DIM	MILLIMETERS		
	MIN	MAX	TYP.
A	10.01	10.31	10.16
B	3.66	3.94	3.80
C	2.59	2.89	2.74
D	3.5	3.96	3.73
E	0.70	0.90	0.80
F	2.54 TYP.		
G	4.98	5.18	5.08
H	13.4	13.8	13.6
I	8.5	8.9	8.70
J	14.65	15.35	15.05
K	4.47	4.67	4.57
L	1.22	1.42	1.32
M	28.05	29.15	28.60
N	2.52	2.82	2.67
O	0.31	0.53	0.42
P	6.10	6.50	6.30
Q	1.17	1.37	1.27

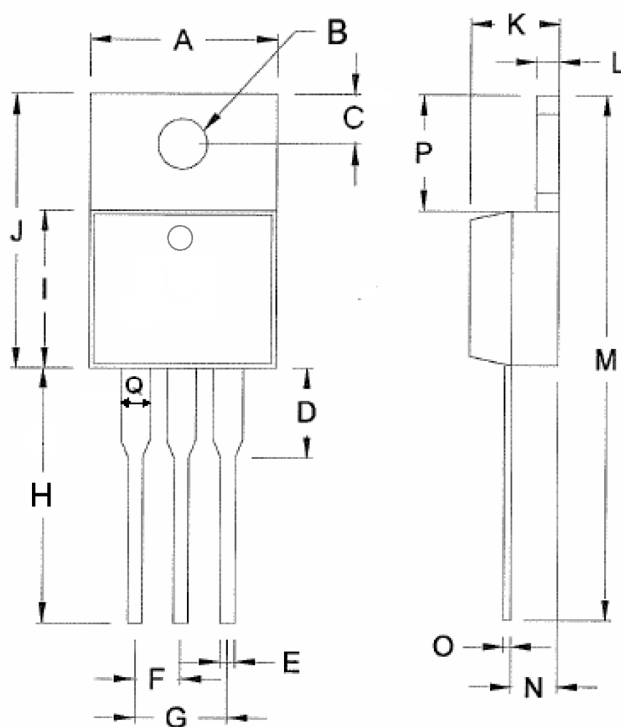

APQ4ESN50AF-XXM0  
TO-220F

TO-220F DIMENSION			
DIM	MILLIMETERS		
	MIN	MAX	TYP.
A	9.96	10.36	10.16
B	6.50 TYP.		6.50
C	3.00	3.20	3.10
E	15.10	16.07	15.59
F	0.55	1.39	0.97
G	2.54 TYP.		
H	12.37	13.5	12.94
I	2.23	3.90	3.07
J	2.90	3.50	3.2
K	4.45	4.93	4.69
L	1.15 TYP.		
M	2.34	2.74	2.54
N	2.56	2.96	2.76
O	6.50	7.10	6.8
P	0.36	0.68	0.52
Q	1.15	1.66	1.41

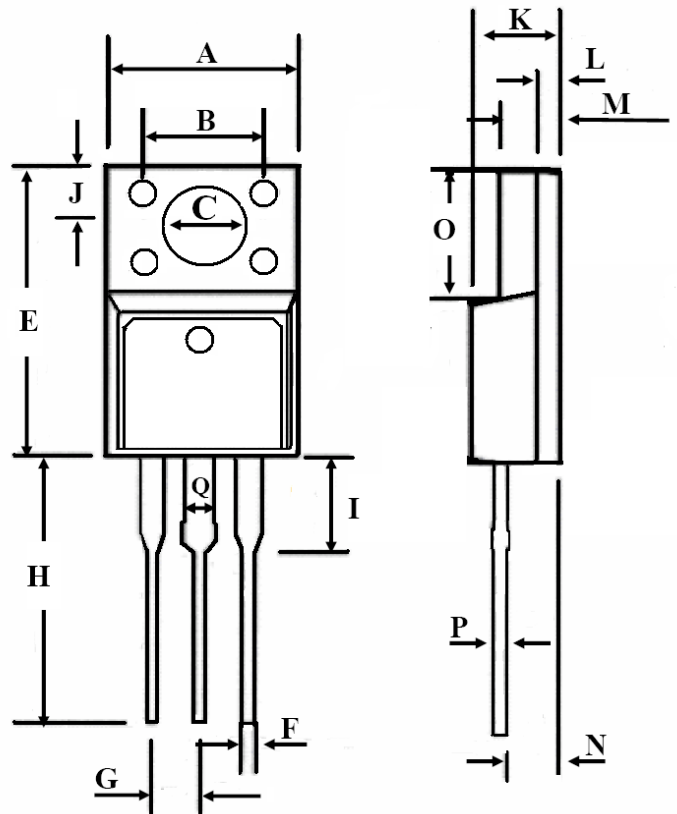



APQ4ESN50AF-XXJ0  
TO-220F

TO-220F DIMENSION			
DIM	MILLIMETERS		
	MIN	MAX	TYP.
A	9.96	10.36	10.16
B	6.50 TYP.		
C	3.5 REF.		
E	14.8	15.2	15.0
F	0.45	0.75	0.55
G	2.54 TYP.		
H	13.23	14.33	13.78
I	3.60	4.00	3.80
J	2.70 TYP.		
K	4.30	4.70	4.50
L	1.30 TYP.		
M	2.80	3.20	3.00
N	2.50	2.90	2.70
O	6.50	7.10	6.8
P	0.45	0.75	0.55
Q	1.05	1.75	1.40

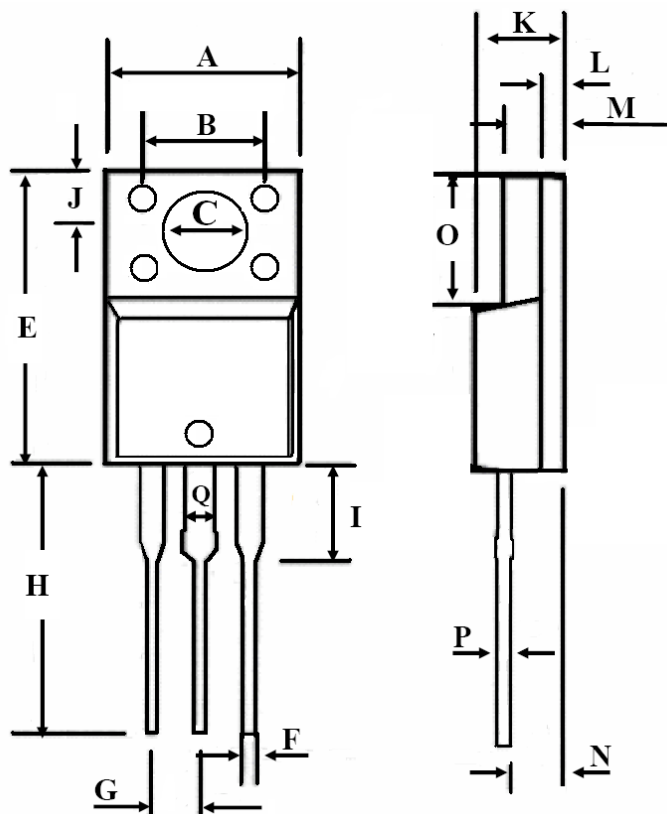



## DEVICE SPECIFICATION

APQ4ESN50AH  
APQ4ESN50AF

---

**500V/4.5A N-Channel MOSFET**

---

### Note

The declared data are only a description of product, information furnished is believed to be accurate and reliable. However, alpha pacific assumes no responsibility for the consequences of use of such information nor for any infringement of patents or other rights of third parties which may result from its use. No license is granted by implication or otherwise under any patent or patent rights of alpha pacific. alpha pacific reserves the right to make changes on this specification without notice at any time.

This publication supersedes and replaces all information previously supplied. All alpha pacific products are not authorized for use as critical components in life support devices or systems, except by a written approval of alpha pacific.

Reprinting this data sheet - or parts of it - is only allowed with a license of alpha pacific.

### contact

**Alpha Pacific Technologies Co., Ltd**  
3F-6, No.18, Lane 609, Sec.5  
Chung Sin road, Shan Chang District,  
New Taipei City, TAIWAN, R.O.C

tel +886-2-2999 5456  
fax +886-2-2999 5270  
internet [www.aptw.com](http://www.aptw.com)