

High Voltage Fast-Switching NPN Power Transistor

Features

- Very High Switching Speed
- Minimum Lot-to-Lot hFE Variation
- Wide Reverse Bias S.O.A

General Description

This device is designed for high voltage, high speed switching characteristic required such as lighting system, switching mode power supply.

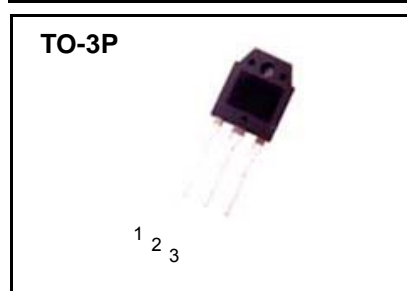
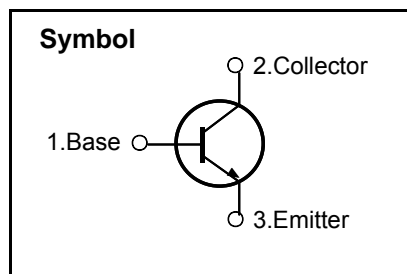

Absolute Maximum Ratings

Symbol	Parameter	Value	Units
V_{CES}	Collector-Emitter Voltage ($V_{BE} = 0$)	700	V
V_{CEO}	Collector-Emitter Voltage ($I_B = 0$)	400	V
V_{EBO}	Emitter-Base Voltage ($I_C = 0$)	9.0	V
I_C	Collector Current	12.0	A
I_{CP}	Collector Pulse Current	24.0	A
I_B	Base Current	6.0	A
I_{BM}	Base Peak Current ($t_p < 5$ ms)	12.0	A
P_C	Total Dissipation at $T_C = 25$ °C	130	W
T_{STG}	Storage Temperature	- 65 ~ 150	°C
T_J	Max. Operating Junction Temperature	150	°C

Thermal Characteristics

Symbol	Parameter	Value	Units
$R_{\theta JC}$	Thermal Resistance, Junction-to-Case	1.67	°C/W
$R_{\theta JA}$	Thermal Resistance, Junction-to-Ambient	62.5	°C/W

SBW13009-S

Electrical Characteristics ($T_C = 25\text{ }^\circ\text{C}$ unless otherwise noted)

Symbol	Parameter	Condition	Min	Typ	Max	Units
I_{CEV}	Collector Cut-off Current ($V_{BE} = -1.5V$)	$V_{CE} = 700V$ $V_{CE} = 700V$ $T_C = 100\text{ }^\circ\text{C}$	-	-	1.0 5.0	mA
$V_{CEO(sus)}$	Collector-Emitter Sustaining Voltage ($I_B = 0$)	$I_C = 10\text{ mA}$	400	-	-	V
$V_{CE(sat)}$	Collector-Emitter Saturation Voltage	$I_C = 5.0A$ $I_B = 1.0A$ $I_C = 8.0A$ $I_B = 1.6A$ $I_C = 12.0A$ $I_B = 3.0A$	-	-	0.5 0.6 1.0	V
$V_{BE(sat)}$	Base-Emitter Saturation Voltage	$I_C = 5.0A$ $I_B = 1.0A$ $I_C = 8.0A$ $I_B = 1.6A$	-	-	1.2 1.6	V
h_{FE}^*	DC Current Gain	$I_C = 5.0A$ $V_{CE} = 5V$ $I_C = 8.0A$ $V_{CE} = 5V$	20 5	-	40 30	
t_s t_f	Storage Time Fall Time	$I_C = 8.0A$ $V_{CC} = 125V$ $I_{B1} = 1.6A$ $I_{B2} = -1.6A$ $T_P = 25\mu s$	-		3.0 0.7	μs



Fig 1. Saturation voltage

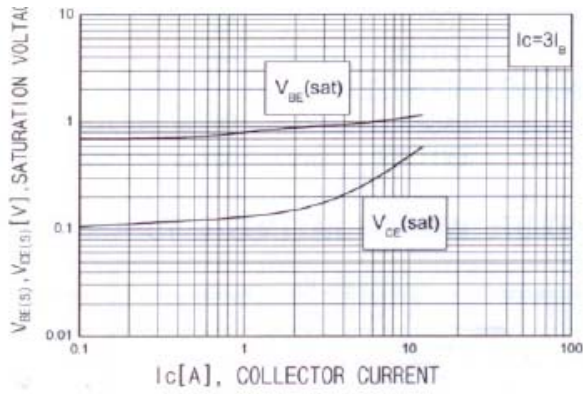

Fig 2. DC Current Gain

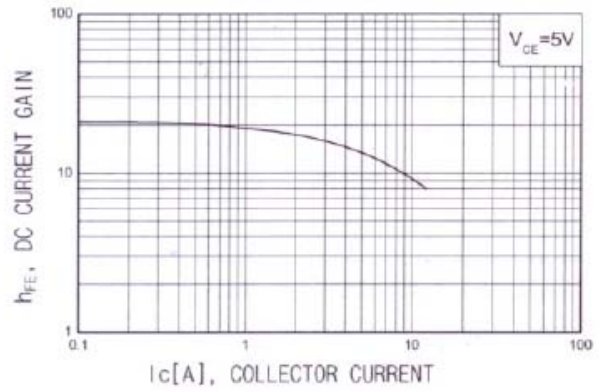

Fig 3. Switching Time

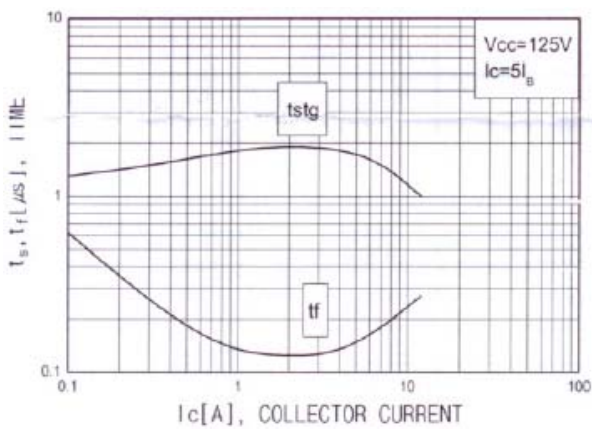

Fig 4. Power Derating

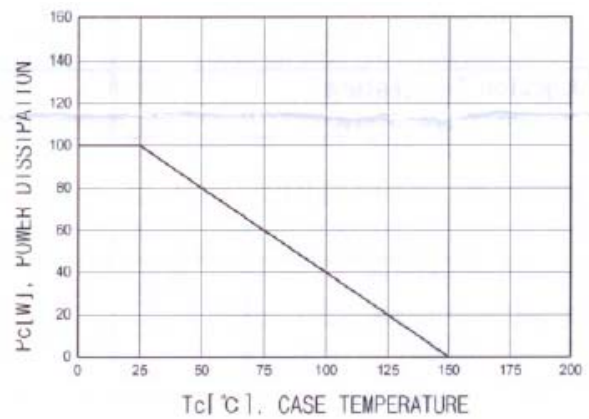

Fig 5. Safe operation area

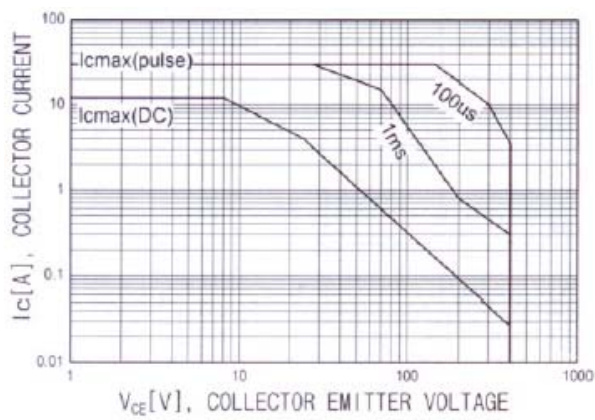
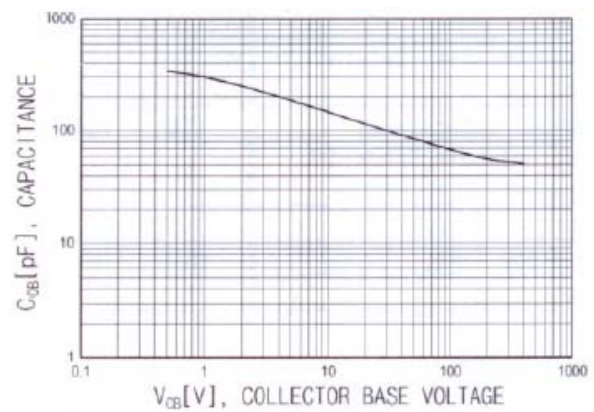
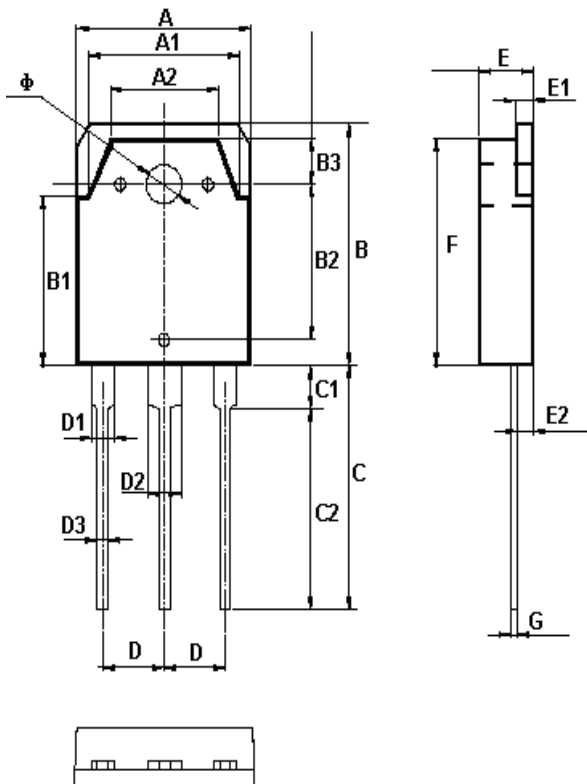

Fig 6. Collect output capacitance



SBW13009-S

TO-3P Dimension



corresponding symbol	measurement	
A(mm)	15.60±0.20	
A1(mm)	13.60±0.20	
A2(mm)dia.	9.60±0.20	
B(mm)	19.90±0.20	
B1(mm)	13.90±0.20	
B2(mm)	12.76±0.20	
B3(mm)	3.80±0.20	
C(mm)	20.00±0.30	
C1(mm)	3.50±0.20	
C2(mm)	16.50±0.30	
D(mm)	5.45(TYP)	
D1	2.0 ±0.20	
D2	3.0±0.20	
D3	1.00±0.20	
E(mm)	4.80±0.20	
E1(mm)	1.50±	+0.15 -0.05
E2(mm)	1.40±0.20	
F(mm)	18.70±0.20	
G(mm)	0.60	+0.15 -0.05
ϕ (mm)	3.20±0.10	

