

20V Dual N-Channel Enhancement Mode MOSFET

DESCRIPTION

The SMC8205AS is the Dual N-Channel logic enhancement mode power field effect transistor which is produced using high cell density, advanced trench technology to provide excellent $R_{DS(ON)}$.

This high density process is especially tailored to minimize on-state resistance. These devices are particularly suited for low voltage application, and low in-line power loss are needed in a very small outline surface mount package.

SMC8205AS6-TRG ROHS Compliant This is Halogen Free

FEATURE

- ◆ 20V/6.0A, $R_{DS(ON)} = 20m\Omega (typ.) @ V_{GS} = 4.5V$
- ◆ 20V/5.2A, $R_{DS(ON)} = 24m\Omega (typ.) @ V_{GS} = 2.5V$
- ◆ Super high density cell design for extremely low $R_{DS(ON)}$
- ◆ Exceptional on-resistance and Maximum DC current capability

APPLICATIONS

- ◆ Power Management in Note book
- ◆ Portable Equipment
- ◆ Battery Powered System



Dual N-Channel Enhancement Mode

PIN CONFIGURATION

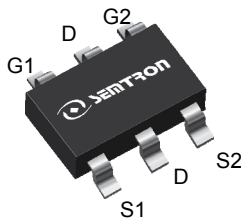

SOT-23-6L
Top View

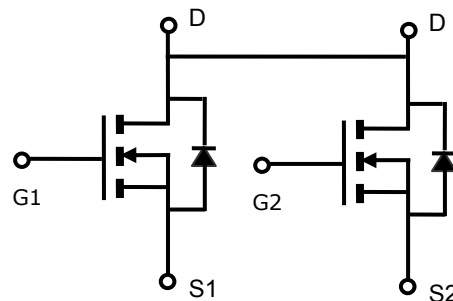

PART NUMBER INFORMATION

<p>SMC 8205A S6 - TR G</p> <p>a b c d e</p>	<p>a : Company name. b : Product Serial number. c : Package code d : Handling code e : Green produce code</p>
--	---

ORDERING INFORMATION

Part Number	Package Code	Handling Code	Shipping
SMC8205AS6-TRG	S6 : SOT-23-6L	TR : Tape&Reel	3K/Reel

- ※ Year Code : 0 ~ 9, 2010 : 0
- ※ Week Code : A(1~2) ~ Z(53~54)
- ※ SOT-23L : Only available in tape and reel packaging.

ABSOLUTE MAXIMUM RATINGS ($T_A = 25^\circ\text{C}$ Unless otherwise noted)

Symbol	Parameter	Typical	Unit
V_{DSS}	Drain-Source Voltage	20	V
V_{GSS}	Gate-Source Voltage	± 12	V
I_D	Continuous Drain Current ($T_C=25^\circ\text{C}$) ^A	6.0	A
	Continuous Drain Current ($T_C=70^\circ\text{C}$) ^A		
I_{DM}	Pulsed Drain Current ^B	20	A
P_D	Power Dissipation	$T_A=25^\circ\text{C}$	1.5
		$T_A=70^\circ\text{C}$	0.9
T_J	Operation Junction Temperature	-55 to 150	$^\circ\text{C}$
T_{STG}	Storage Temperature Range	-55 to 150	$^\circ\text{C}$

Note: Absolute maximum ratings are those values beyond which the device could be permanently damaged.
 Absolute maximum ratings are stress ratings only and functional device operation is not implied.

THERMAL DATA

Symbol	Parameter	Typ	Max	Unit	
$R_{\theta JA}$	Thermal Resistance-Junction to Ambient ^A	Steady-State	-	80	$^\circ\text{C}/\text{W}$
$R_{\theta JL}$	Thermal Resistance Junction to Lead ^A	Steady-State	-	62.5	$^\circ\text{C}/\text{W}$

ELECTRICAL CHARACTERISTICS ($T_J = 25^\circ\text{C}$ Unless otherwise noted)

Symbol	Parameter	Condition	Min	Typ	Max	Unit
Static Parameters						
$V_{(BR)DSS}$	Drain-Source Breakdown Voltage	$V_{GS}=0V, I_D=250\mu A$	20			V
$V_{GS(th)}$	Gate Threshold Voltage	$V_{DS}=V_{GS}, I_D=250\mu A$	0.5		1.0	V
I_{GSS}	Gate Leakage Current	$V_{DS}=0V, V_{GS}=\pm 12V$			± 100	nA
I_{DSS}	Zero Gate Voltage, Drain-Source Leakage Current	$V_{DS}=16V, V_{GS}=0V$ $T_J=25^\circ\text{C}$			1	μA
		$V_{DS}=16V, V_{GS}=0V$ $T_J=55^\circ\text{C}$			5	
$R_{DS(ON)}$	Drain-source On-Resistance ^B	$V_{GS}=4.5V, I_D=6.0A$ $V_{GS}=2.5V, I_D=5.2A$		20 24	25 32	m Ω
G_{fs}	Forward Transconductance	$V_{DS}=15V, I_D=3.6A$		10		S
Source-Drain Diode						
V_{SD}	Diode Forward Voltage	$I_S=1.0A, V_{GS}=0V$		0.7	1.0	V
I_S	Continuous Source Current ^{AD}				10	A
Dynamic Parameters						
$Q_g(4.5V)$	Total Gate Charge	$V_{DS}=10V$ $V_{GS}=4.5V$ $I_D=6.0A$		21	29	nC
Q_{gs}	Gate-Source Charge			1.3		
Q_{gd}	Gate-Drain Charge			3.3		
C_{iss}	Input Capacitance	$V_{DS}=10V$ $V_{GS}=0V$ $f=1\text{MHz}$		580		pF
C_{oss}	Output Capacitance			138		
C_{rss}	Reverse Transfer Capacitance			120		
$t_{d(on)}$	Turn-On Time	$V_{DD}=10V$ $I_D=6A$		3.5	7	nS
t_r				13.5	24	
$t_{d(off)}$	Turn-Off Time	$V_{GEN}=4.5V$ $R_G=3.3\Omega$		32	58	
t_f				6.6	13	

Note:

- The value of $R_{\theta JA}$ is measured with the device mounted on 1in 2 FR-4 board with 2oz. Copper, in a still air environment with $T_A=25^\circ\text{C}$.
- The data tested by pulsed, pulse width $\leq 300\mu\text{s}$, duty cycle $\leq 2\%$
- The EAS data shows Max. rating. The test condition is $V_{DD}=-25V, V_{GS}=-10V, L=0.1\text{mH}$.
- The data is theoretically the same as I_D and I_{DM} , in real applications, should be limited by total power dissipation.

The products and product specifications contained herein are subject to change without notice to improve performance characteristics. Consult us, or our representatives before use, to confirm that the information in this datasheet is up to date

We assume no responsibility for any infringement of patents, patent rights, or other rights arising from the use of any information and circuitry in this datasheet.

TYPICAL CHARACTERISTICS (25°C Unless Note)

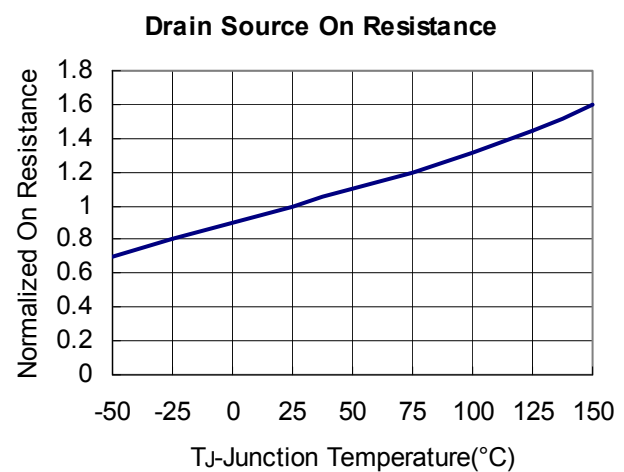
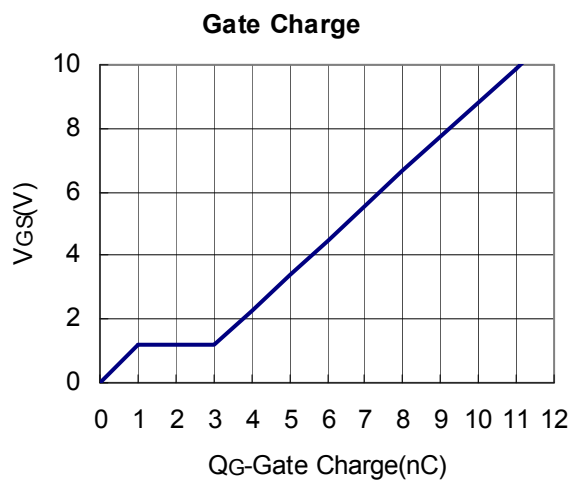
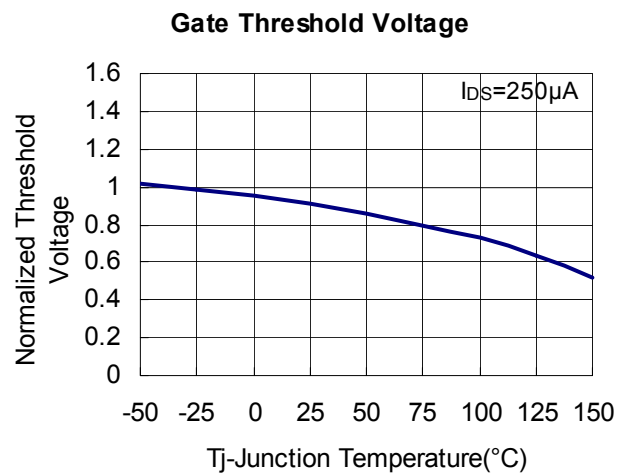
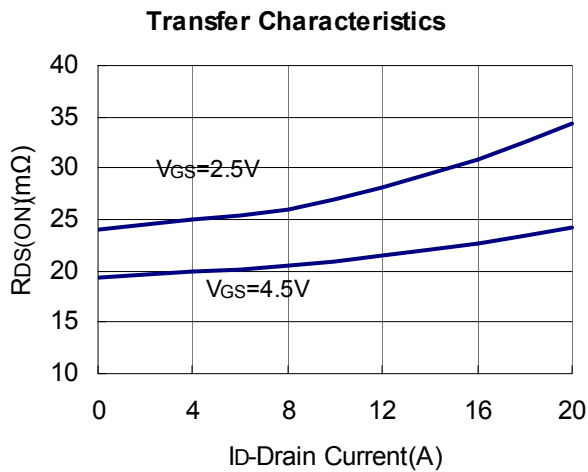
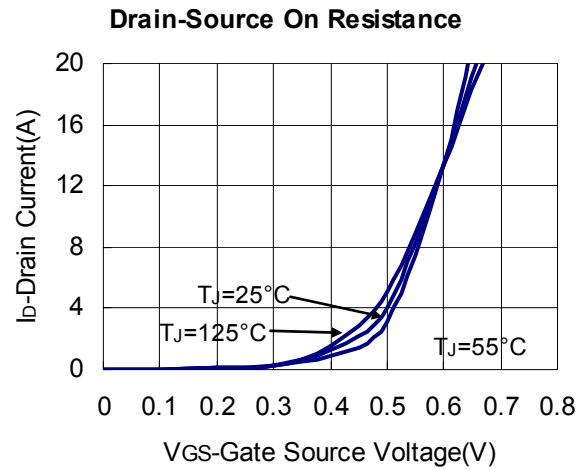
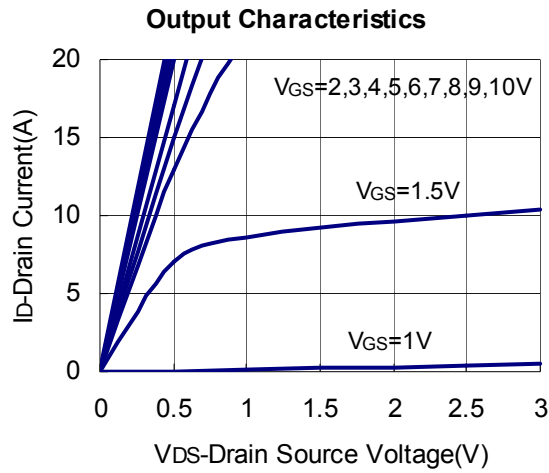

TYPICAL CHARACTERISTICS (25°C Unless Note)

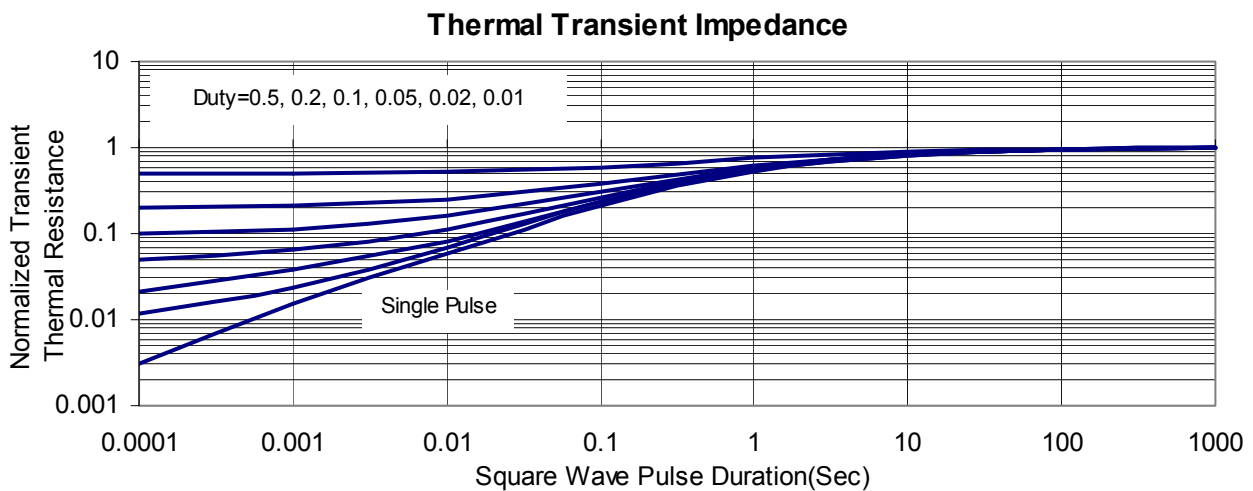
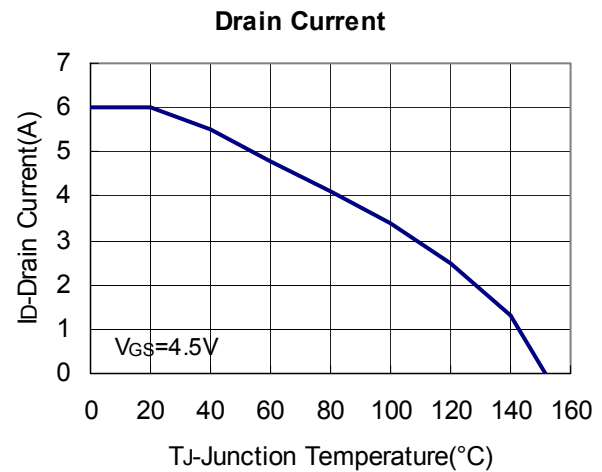
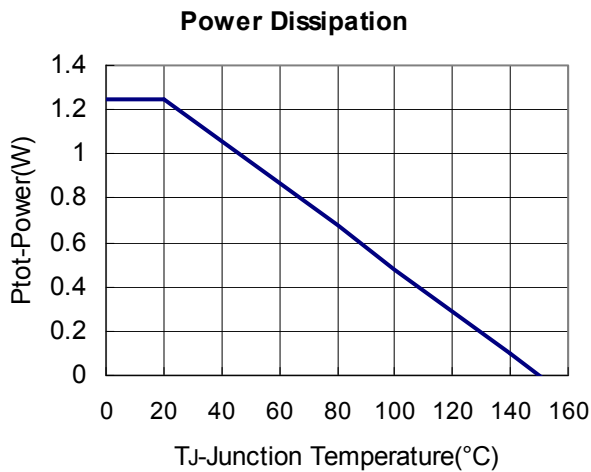
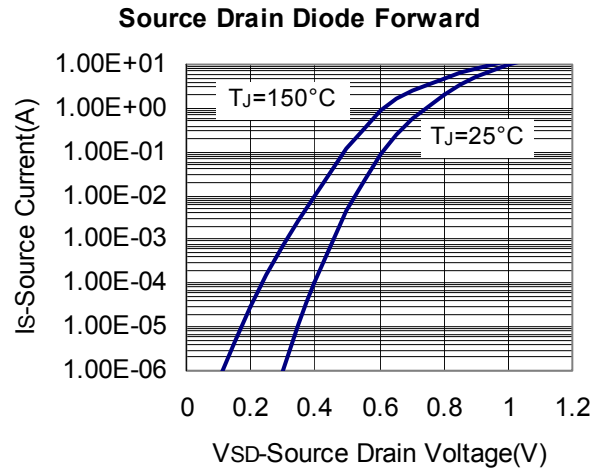
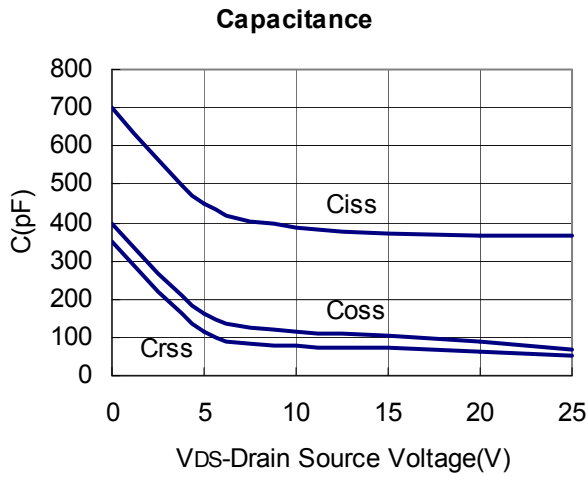

SOT-23-6L PACKAGE DIMENSIONS

Symbol	Dimensions In Millimeters		Dimensions In Inches	
	Min.	Max.	Min.	Max.
A	-	1.300	-	0.051
A1	0.040	0.100	0.002	0.004
A2	1.000	1.200	0.039	0.047
A3	0.550	0.750	0.022	0.030
b	0.340	0.430	0.013	0.017
b1	0.330	0.380	0.013	0.015
c	0.150	0.210	0.006	0.008
c1	0.140	0.160	0.006	0.006
D	2.720	3.120	0.107	0.123
E	2.600	3.000	0.102	0.118
E1	1.400	1.800	0.055	0.071
e	0.950 BSC		0.066 BSC	
L	0.300	0.600	0.012	0.024
θ	0°	8°	0°	8°

