

N-channel MOSFET

Features

- High ruggedness
- $R_{DS(ON)}$ (Max 2.2 Ω) @ $V_{GS}=10V$
- Gate Charge (Typ 30nC)
- Improved dv/dt Capability
- 100% Avalanche Tested

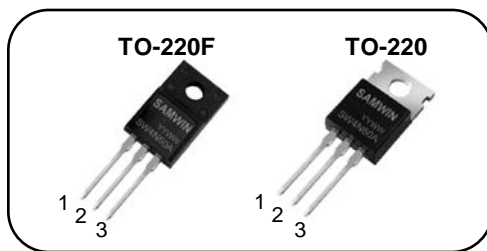

1. Gate 2. Drain 3. Source

BV_{DSS} :	600V
I_D :	4.0A
$R_{DS(ON)}$:	2.2ohm

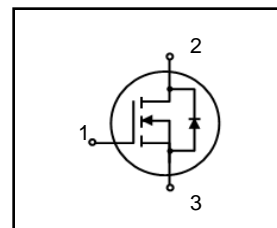

General Description

This power MOSFET is produced with advanced VDMOS technology of SAMWIN. This technology enable power MOSFET to have better characteristics, such as fast switching time, low on resistance, low gate charge and especially excellent avalanche characteristics. This power MOSFET is usually used at high efficient DC to DC converter block and switch mode power supply.

Order Codes

Item	Sales Type	Marking	Package	Packaging
1	SW P 4N60	SW4N60	TO-220	TUBE
2	SW F 4N60	SW4N60	TO-220F	TUBE

Absolute maximum ratings

Symbol	Parameter	Value		Unit
		TO-220	TO-220F	
V_{DSS}	Drain to Source Voltage	600		V
I_D	Continuous Drain Current (@ $T_C=25^\circ C$)	4.0	4.0*	A
	Continuous Drain Current (@ $T_C=100^\circ C$)	2.5	2.5*	A
I_{DM}	Drain current pulsed (note 1)	16		A
V_{GS}	Gate to Source Voltage	± 30		V
E_{AS}	Single pulsed Avalanche Energy (note 2)	405		mJ
E_{AR}	Repetitive Avalanche Energy (note 1)	43		mJ
dv/dt	Peak diode Recovery dv/dt (note 3)	4		V/ns
P_D	Total power dissipation (@ $T_C=25^\circ C$)	198	33	W
	Derating Factor above 25°C	1.58	0.26	W/°C
T_{STG}, T_J	Operating Junction Temperature & Storage Temperature	-55 ~ + 150		°C
T_L	Maximum Lead Temperature for soldering purpose, 1/8 from Case for 5 seconds.	300		°C

*. Drain current is limited by junction temperature.

Thermal characteristics

Symbol	Parameter	Value		Unit
		TO-220	TO-220F	
R_{thjc}	Thermal resistance, Junction to case	0.63	3.8	°C/W
R_{thcs}	Thermal resistance, Case to Sink	0.5	-	°C/W
R_{thja}	Thermal resistance, Junction to ambient	65		°C/W

Electrical characteristic ($T_C = 25^\circ\text{C}$ unless otherwise specified)

Symbol	Parameter	Test conditions	Min.	Typ.	Max.	Unit
Off characteristics						
BV_{DSS}	Drain to source breakdown voltage	$V_{GS}=0V, I_D=250\mu A$	600	-	-	V
$\Delta BV_{DSS} / \Delta T_J$	Breakdown voltage temperature coefficient	$I_D=250\mu A$, referenced to 25°C	-	0.46	-	V/ $^\circ\text{C}$
I_{DSS}	Drain to source leakage current	$V_{DS}=600V, V_{GS}=0V$	-	-	1	μA
		$V_{DS}=480V, T_C=125^\circ\text{C}$	-	-	10	μA
I_{GSS}	Gate to source leakage current, forward	$V_{GS}=30V, V_{DS}=0V$	-	-	100	nA
	Gate to source leakage current, reverse	$V_{GS}=-30V, V_{DS}=0V$	-	-	-100	nA
On characteristics						
$V_{GS(TH)}$	Gate threshold voltage	$V_{DS}=V_{GS}, I_D=250\mu A$	2.0	-	4.0	V
$R_{DS(ON)}$	Drain to source on state resistance	$V_{GS}=10V, I_D = 2A$	-	1.85	2.2	Ω
G_{fs}	Forward Transconductance	$V_{DS} = 40 V, I_D = 2 A$	2	-	-	S
Dynamic characteristics						
C_{iss}	Input capacitance	$V_{GS}=0V, V_{DS}=25V, f=1\text{MHz}$	-	570	740	pF
C_{oss}	Output capacitance		-	64	83	
C_{rss}	Reverse transfer capacitance		-	14	18	
$t_{d(on)}$	Turn on delay time	$V_{DS}=300V, I_D=4A, R_G=25\Omega$ (note 4,5)	-	12	30	ns
t_r	Rising time		-	30	80	
$t_{d(off)}$	Turn off delay time		-	93	150	
t_f	Fall time		-	38	50	
Q_g	Total gate charge	$V_{DS}=480V, V_{GS}=10V, I_D=4A$ (note 4,5)	-	30	50	nC
Q_{gs}	Gate-source charge		-	3.7	-	
Q_{gd}	Gate-drain charge		-	17	-	

Source to drain diode ratings characteristics

Symbol	Parameter	Test conditions	Min.	Typ.	Max.	Unit
I_S	Continuous source current	Integral reverse p-n Junction diode in the MOSFET	-	-	4	A
I_{SM}	Pulsed source current		-	-	16	A
V_{SD}	Diode forward voltage drop.	$I_S=4A, V_{GS}=0V$	-	-	1.5	V
T_{rr}	Reverse recovery time	$I_S=4A, V_{GS}=0V,$	-	334	-	ns
Q_{rr}	Breakdown voltage charge	$di_f/dt=100A/\mu s$	-	2.5	-	μC

※. Notes

1. Repetitive rating : pulse width limited by junction temperature.
2. $L = 50.6\text{mH}, I_{AS} = 4A, V_{DD} = 50V, R_G=25\Omega$, Starting $T_J = 25^\circ\text{C}$
3. $I_{SD} \leq 4A, di/dt = 100A/\mu s, V_{DD} \leq BV_{DSS}$, Starting $T_J = 25^\circ\text{C}$
4. Pulse Test : Pulse Width $\leq 300\mu s$, duty cycle $\leq 2\%$.
5. Essentially independent of operating temperature.

Fig. 1. On-state characteristics

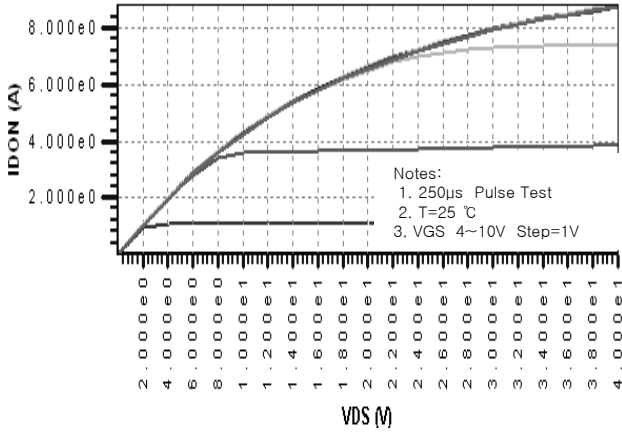

Fig. 2. On-resistance variation vs. drain current and gate voltage

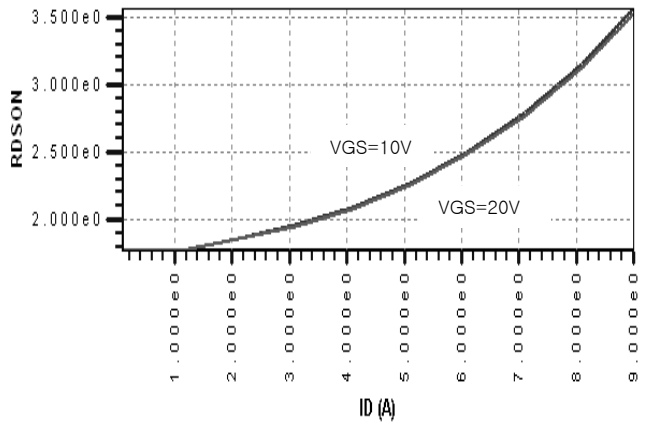

Fig. 3. Gate charge characteristics

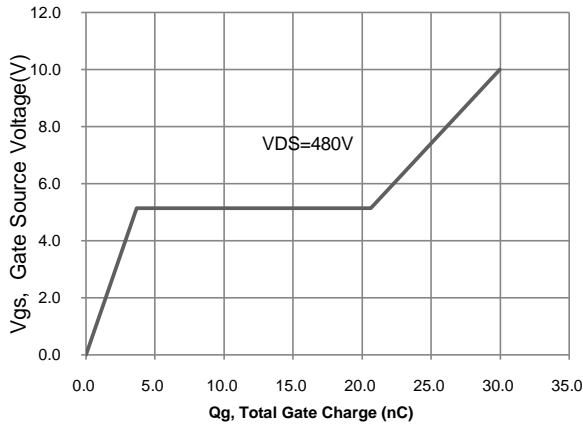

Fig. 4. On state current vs. diode forward voltage

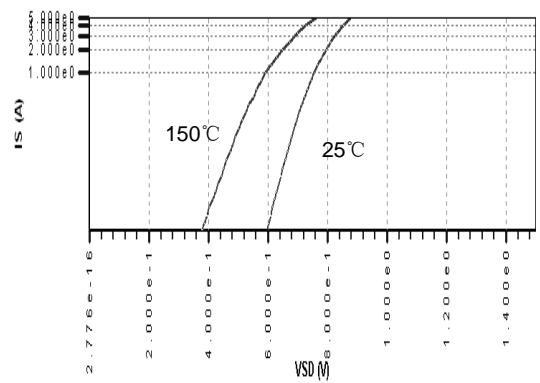

Fig 5. Breakdown Voltage Variation vs. Junction Temperature

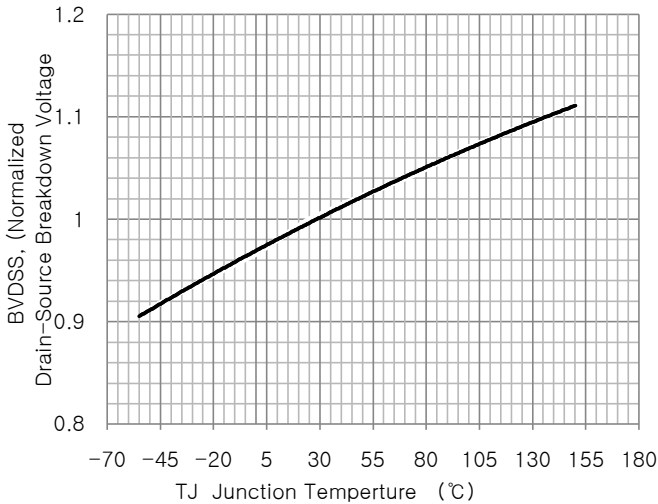

Fig. 6. On resistance variation vs. junction temperature

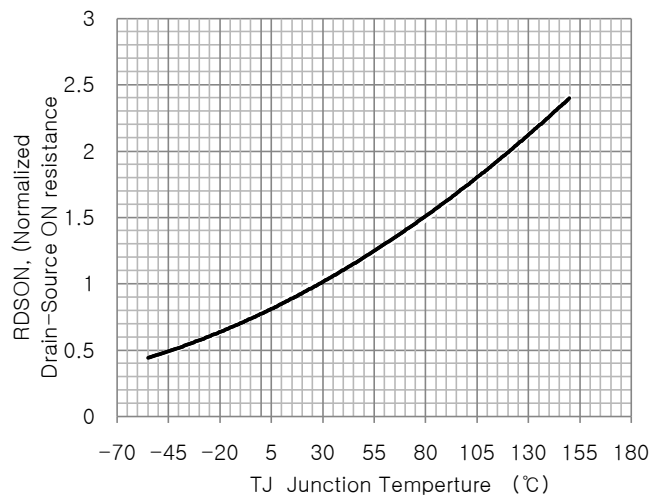

Fig. 7. Maximum safe operating area

Fig. 8. Transient thermal response curve

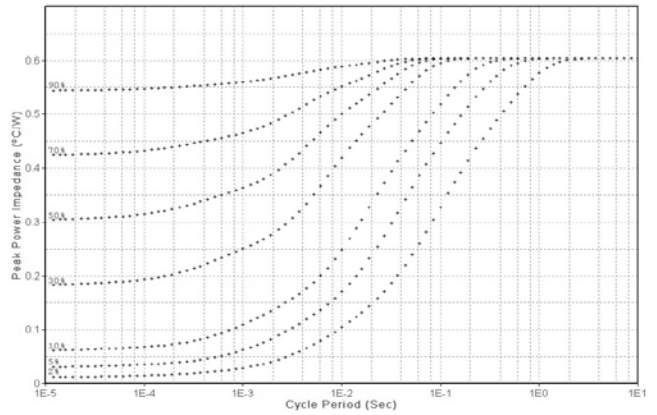
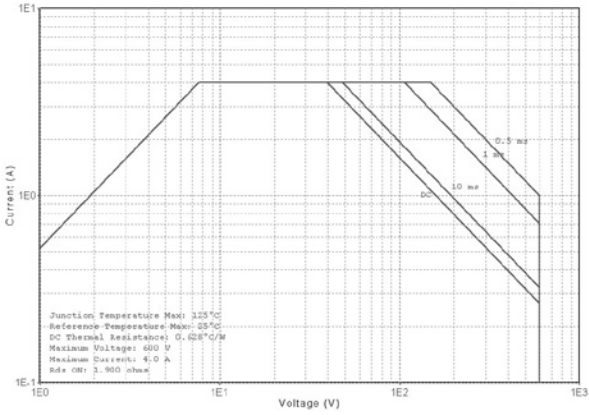

Fig. 9. Gate charge test circuit & waveform

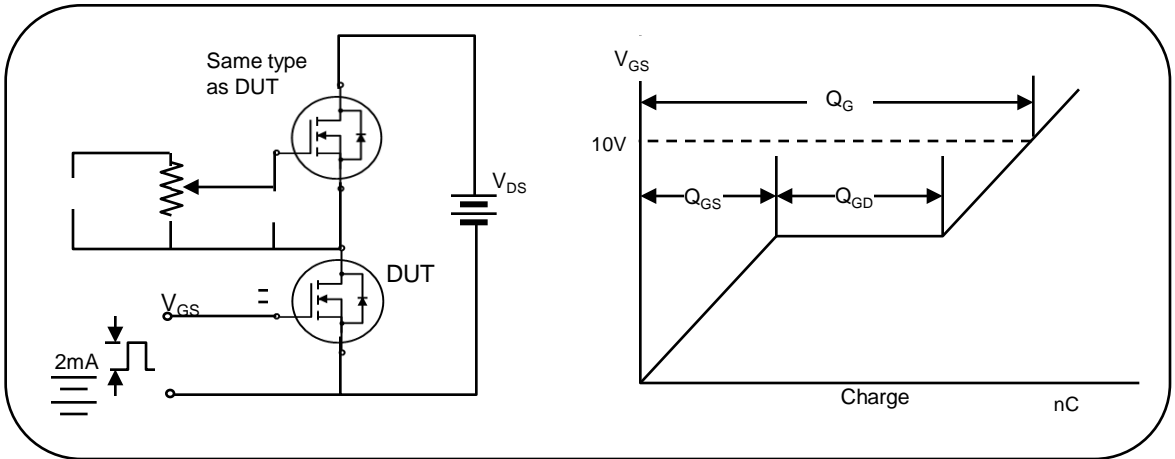

Fig. 10. Switching time test circuit & waveform

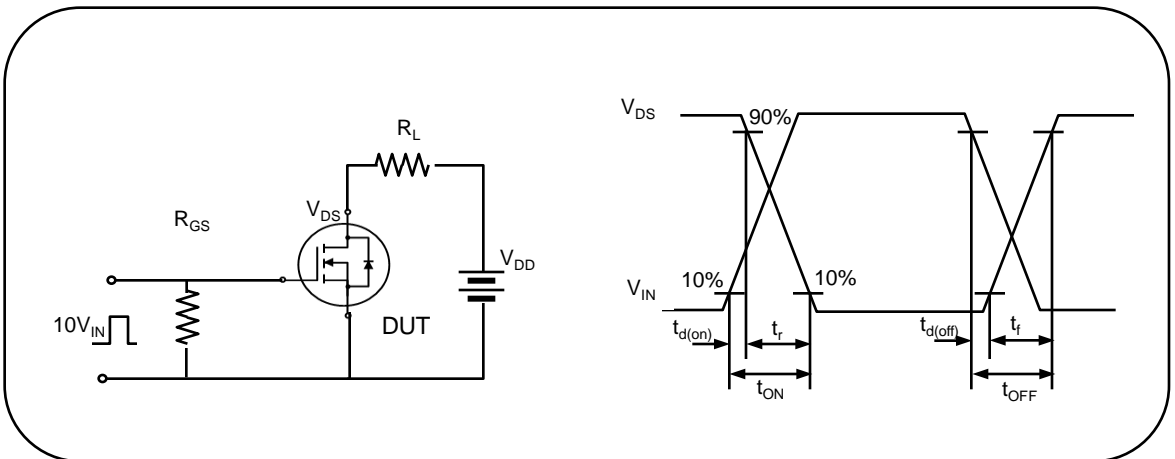

Fig. 11. Unclamped Inductive switching test circuit & waveform

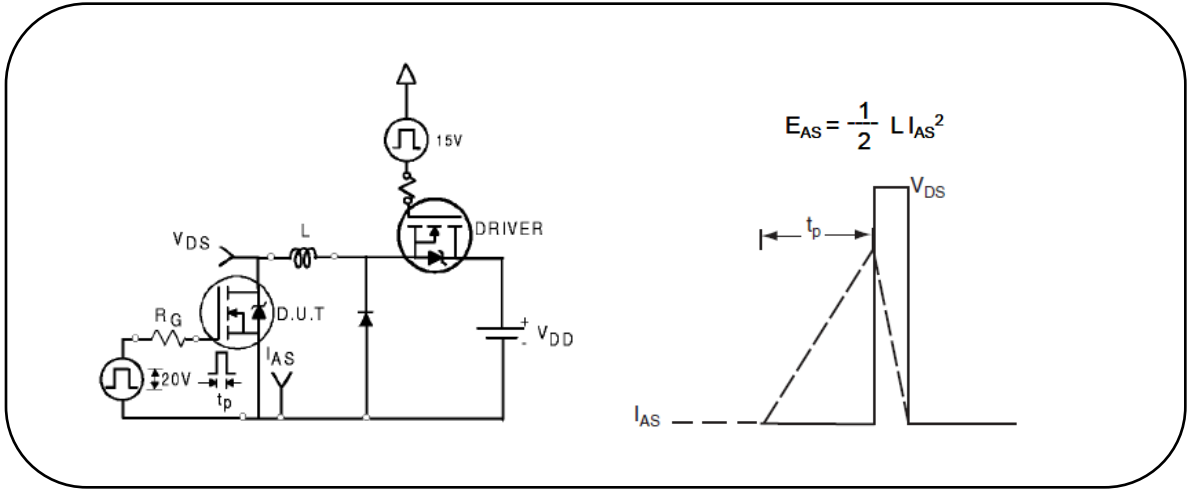

Fig. 12. Peak diode recovery dv/dt test circuit & waveform

