

Features

- Low On-Resistance $R_{DS(on)max}$ of 0.045Ω
- Voltage controlled
- Maximum operating temperature of 175°C
- Extremely fast switching not dependent on temperature
- Low gate charge
- Low intrinsic capacitance

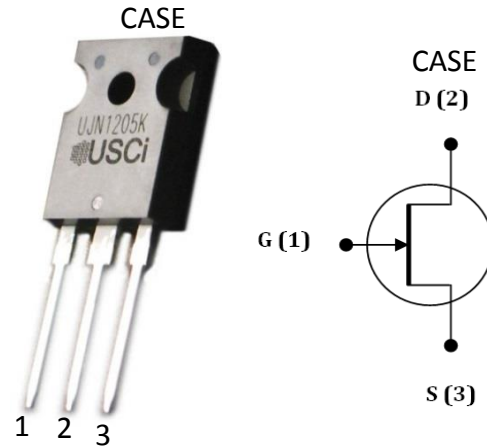

Typical Applications

- Over Current Protection Circuits
- DC-AC Inverters
- Switch Mode Power Supplies
- Power Factor Correction Modules
- Motor Drives
- Induction Heating

Part Number	Package	Marking
UJN1205K	TO-247	UJN1205K

Descriptions

United Silicon Carbide, Inc offers the **xJ series** of high-performance SiC normally-on JFET transistors. This series exhibits ultra-low on resistance ($R_{DS(ON)}$) and gate charge (Q_g) allowing for low conduction and switching loss. The device normally-on characteristics with low $R_{DS(ON)}$ at $V_{GS} = 0V$ is also ideal for current protection circuits without the need for active control, as well as for cascode operation.

Absolute Maximum Ratings

Parameter	Symbol	Test Conditions	Value	Units
Drain-Source Voltage	V_{DS}		1200	V
Gate-Source Voltage	V_{GS}	DC	-20 to +3	V
		AC ⁽¹⁾	-20 to +20	
Continuous Drain Current	I_D	$T_C = 25^\circ C$	38	A
Continuous Drain Current	I_D	$T_C = 125^\circ C$	23	A
Pulsed Drain Current	I_{DM}	$T_j = 125^\circ C$	80	A
		$T_j = 175^\circ C$	55	
Power Dissipation	P_{tot}	$T_C = 25^\circ C$	230	W
Operating and Storage Temperature	T_j, T_{STG}		-55 to 175	°C
Max Lead Temperature for Soldering, 1/8" from Case for 5 Seconds	T_L		250	°C

(1) +20V AC rating applies for turn-on pulses <200ns applied with external $R_G > 1\Omega$.

Electrical Characteristics ($T_J = +25^\circ\text{C}$ unless otherwise specified)

Typical Performance - Static

Parameter	Symbol	Test Conditions	Value			Units
			Min	Typ	Max	
Drain-Source Breakdown Voltage	BV_{DS}	$V_{GS} = -20V, I_D = 1mA$	1200			V
Total Drain Leakage Current	I_D	$V_{DS} = 1200V,$ $V_{GS} = -20V, T_J = 25^\circ\text{C}$		10	500	μA
		$V_{DS} = 1200V,$ $V_{GS} = -20V, T_J = 175^\circ\text{C}$		30	1500	
Total Gate Leakage Current	I_G	$V_{GS} = -20V, T_J = 25^\circ\text{C}$		1	250	μA
		$V_{GS} = -20V, T_J = 175^\circ\text{C}$		10		
Drain-Source On-Resistance	$R_{DS(on)}$	$V_{GS} = 2V, I_F = 30A,$ $T_J = 25^\circ\text{C}$		35	45	mΩ
		$V_{GS} = 0V, I_F = 20A,$ $T_J = 25^\circ\text{C}$		42	55	
		$V_{GS} = 2V, I_F = 30A,$ $T_J = 175^\circ\text{C}$		105	135	
		$V_{GS} = 0V, I_F = 20A,$ $T_J = 175^\circ\text{C}$		135	165	
Gate Threshold Voltage	$V_{G(th)}$	$V_{DS} = 5V, I_D = 70mA$	-10	-6	-4	V
Gate Resistance	R_G	$V_{GS} = 0V, f = 1MHz$		5		Ω

Typical Performance - Dynamic

Parameter	symbol	Test Conditions	Value			Units
			Min	Typ	Max	
Input Capacitance	C_{iss}	$V_{DS} = 100V,$ $V_{GS} = -20V,$ $f = 100kHz$		1020		pF
Output Capacitance	C_{oss}			154		
Reverse Transfer Capacitance	C_{rss}			146		
Effective Output Capacitance, Energy Related	$C_{oss(er)}$	$V_{DS} = 0V$ to 600V, $V_{GS} = -20V$		91		pF
Total Gate Charge	Q_G	$V_{DS}=600V, I_D = 30A,$ $V_{GS}=-15V$ to 2.5V		107		nC
Gate-Drain Charge	Q_{GD}			74		
Gate-Source Charge	Q_{GS}			10		
Turn-on Delay Time	$t_{d(on)}$	$V_{DS}=600V, I_D=30A,$ Gate Driver = -15V to +5V, $R_{G,EXT} = 2.5\Omega,$ Inductive Load, $T_J = 25^\circ C$		30		ns
Rise Time	t_r			28		
Turn-off Delay Time	$t_{d(off)}$			32		
Fall Time	t_f			35		
Turn-on Energy	E_{ON}			467		
Turn-off Energy	E_{OFF}		515			
Total Switching Energy	E_{TOTAL}		982			
Turn-on Delay Time	$t_{d(on)}$	$V_{DS}=600V, I_D=30A,$ Gate Driver = -15V to +5V, $R_{G,EXT} = 2.5\Omega,$ Inductive Load, $T_J = 150^\circ C$		32		ns
Rise Time	t_r			30		
Turn-off Delay Time	$t_{d(off)}$			32		
Fall Time	t_f			33		
Turn-on Energy	E_{ON}			512		μJ
Turn-off Energy	E_{OFF}			448		
Total Switching Energy	E_{TOTAL}			960		

Thermal characteristics

Parameter	symbol	Test Conditions	Value			Units
			Min	Typ	Max	
Thermal Resistance, Junction-to-Case	$R_{\theta JC}$				0.65	$^\circ C/W$

Typical Performance Diagrams

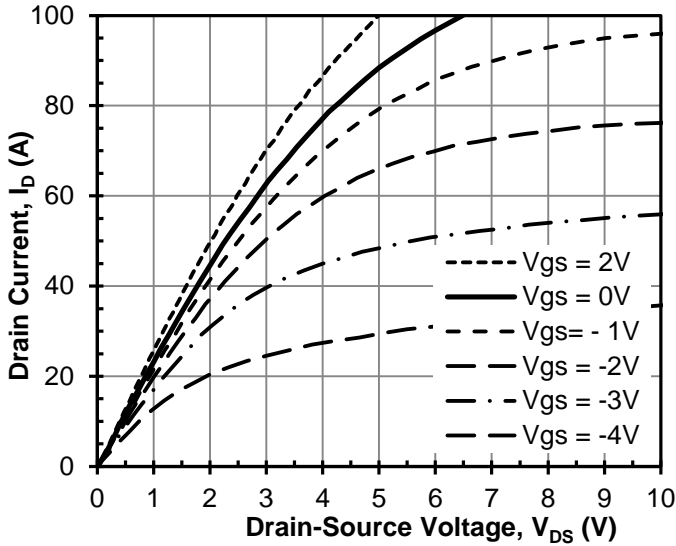

Figure 1 Typical output characteristics at $T_j = 25^\circ\text{C}$

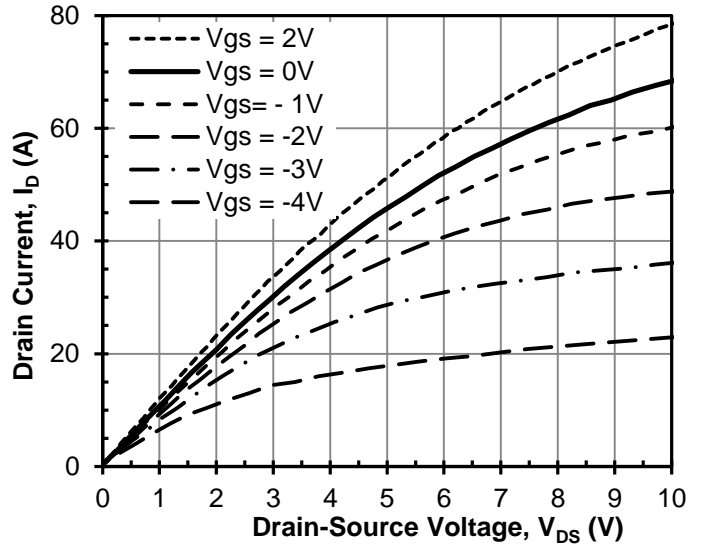

Figure 2 Typical output characteristics at $T_j = 125^\circ\text{C}$

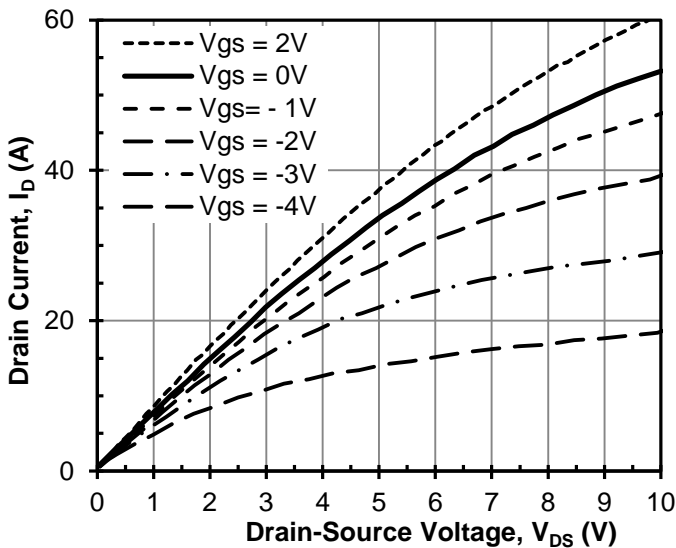

Figure 3 Typical output characteristics at $T_j = 175^\circ\text{C}$

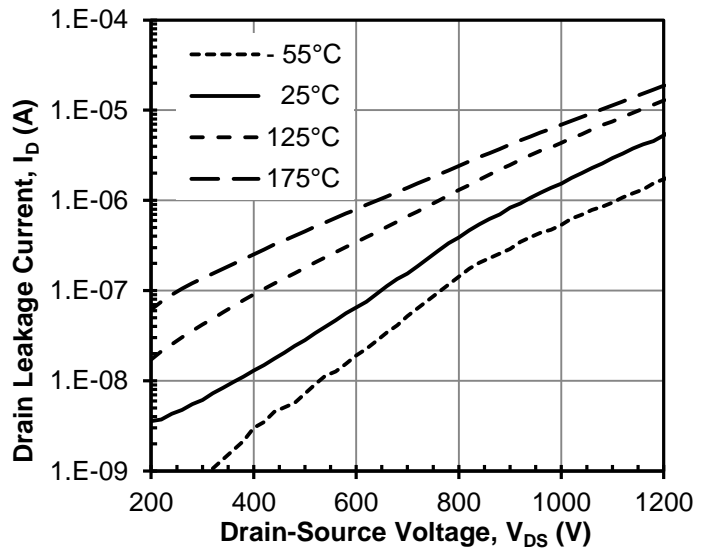

Figure 4 Typical drain-source leakage at $V_{GS} = -20\text{V}$

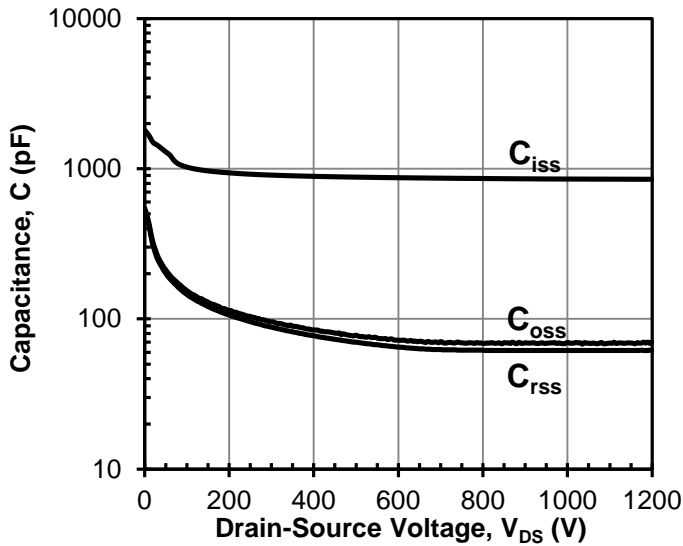

Figure 5 Typical capacitances at 100kHz

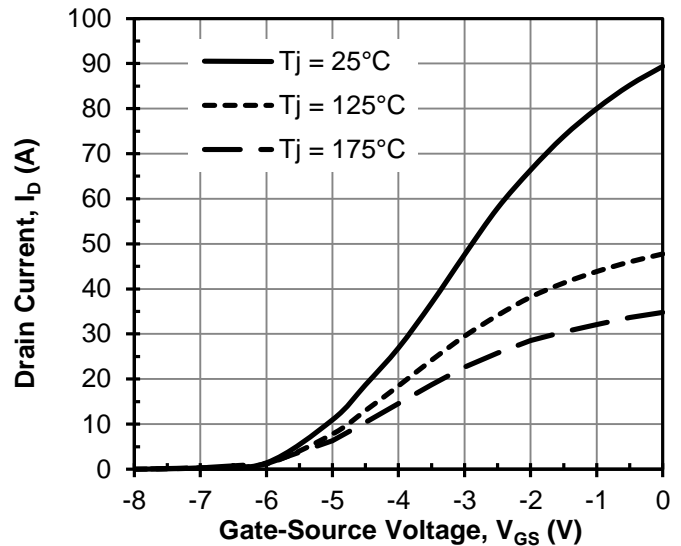

Figure 6 Typical transfer characteristics at $V_{DS} = 5V$

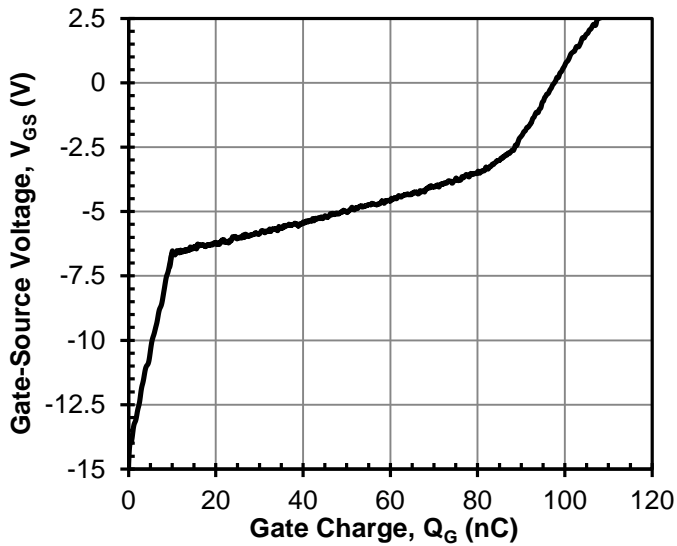

Figure 7 Typical gate charge at $V_{DS} = 600V$ and $I_D = 30A$

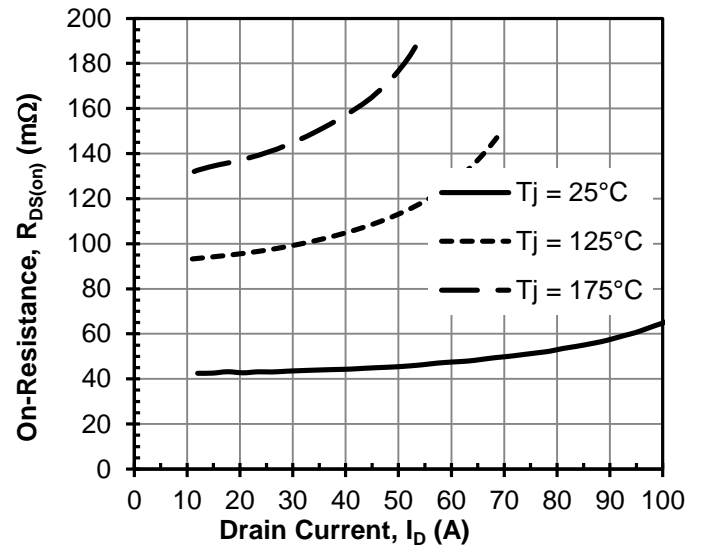

Figure 8 Typical drain-source on-resistance at $V_{GS} = 0V$

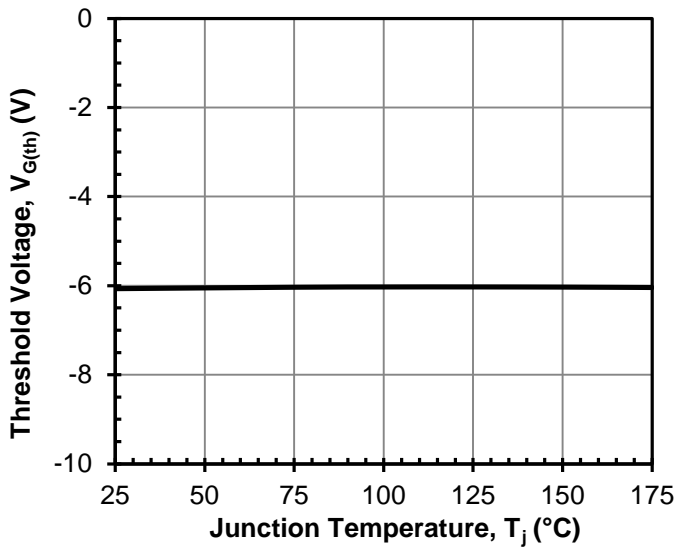

Figure 9 Threshold voltage vs. T_j
at $V_{DS} = 5V$ and $I_D = 70mA$

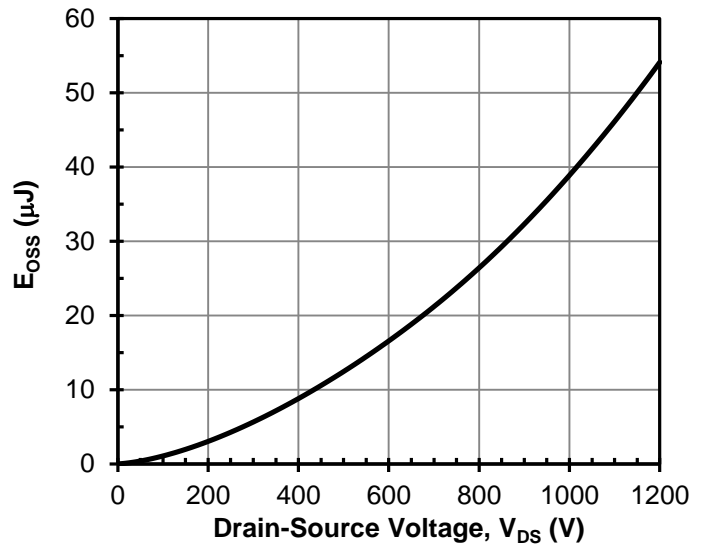

Figure 10 Typical stored energy in C_{oss}
at $V_{GS} = -20V$

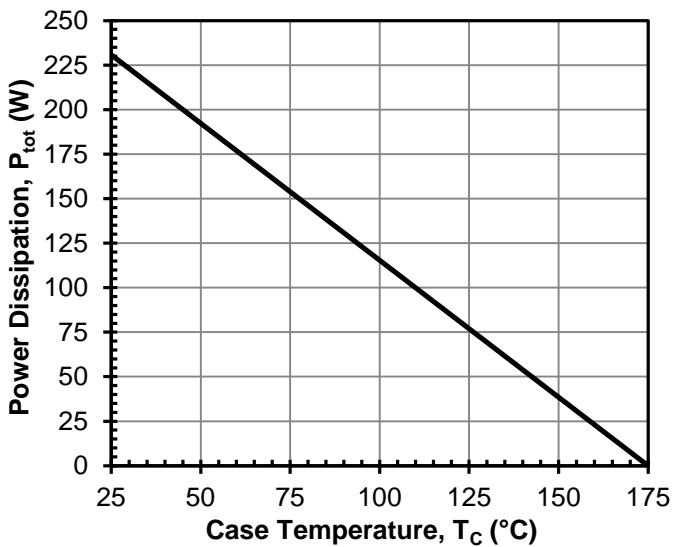

Figure 11 Total power Dissipation

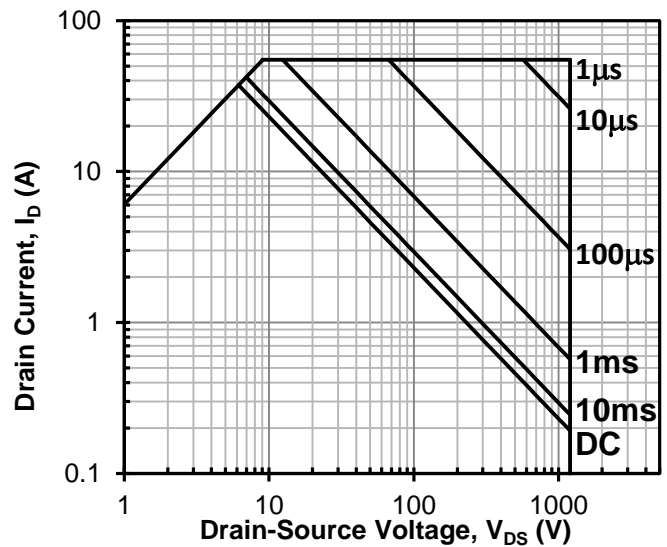

Figure 12 Safe operation area
 $T_c = 25^\circ C$, Parameter t_p

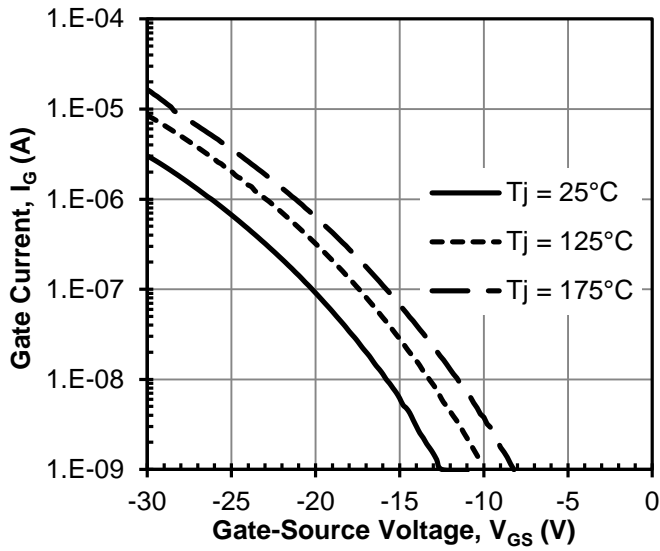

Figure 13 Typical gate leakage current at $V_{DS} = 0V$

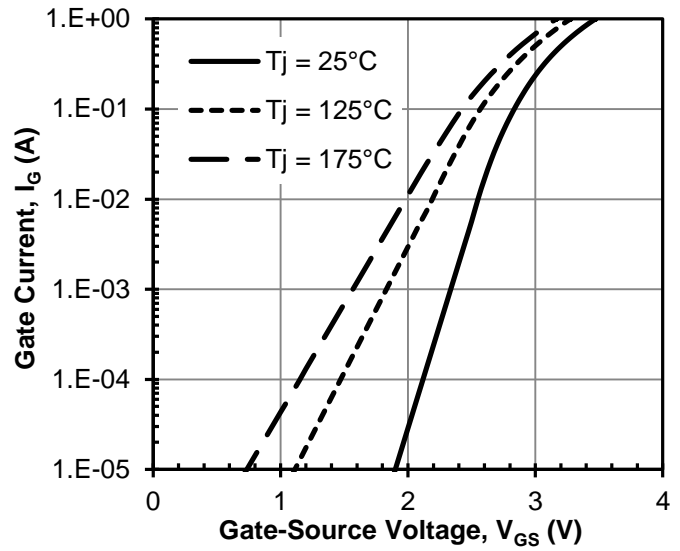

Figure 14 Typical gate forward current at $V_{DS} = 0V$

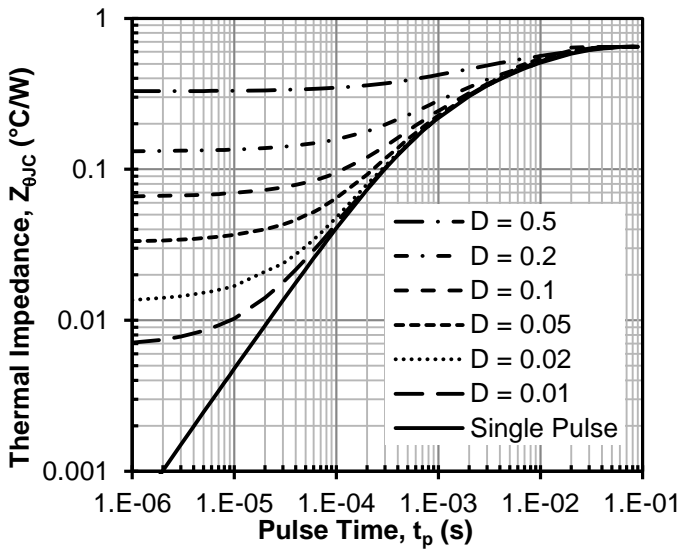
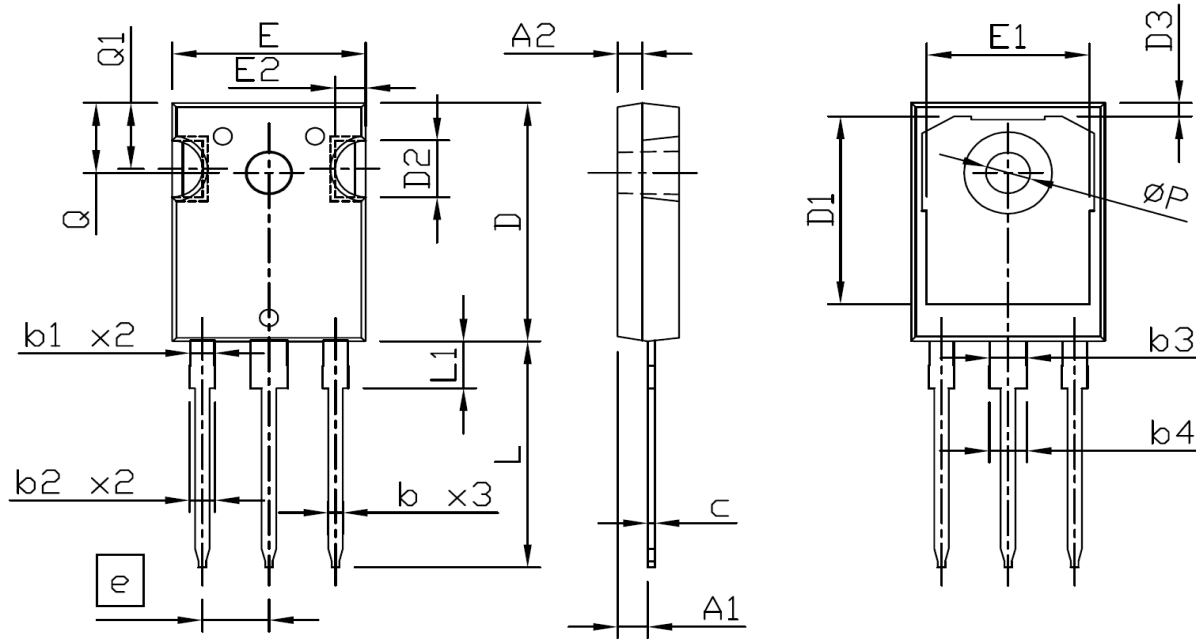
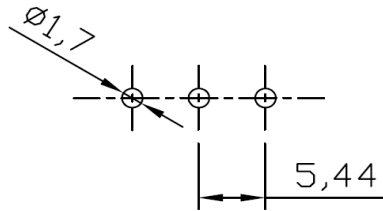

Figure 15 Maximum transient thermal impedance

Mechanical Characteristics



RECOMMENDED LAND PATTERN



UNIT: mm

SYMBOLS	DIMENSIONS IN MILLIMETERS			DIMENSIONS IN INCHES		
	MIN	NOM	MAX	MIN	NOM	MAX
A	4.90	5.00	5.10	0.193	0.197	0.201
A1	2.31	2.42	2.52	0.091	0.095	0.099
A2	1.90	2.00	2.10	0.075	0.079	0.083
b	1.16	1.22	1.27	0.046	0.048	0.050
b1	1.96	2.02	2.07	0.078	0.080	0.081
b2	2.00	2.10	2.20	0.079	0.083	0.087
b3	2.96	3.02	3.07	0.117	0.119	0.121
b4	3.00	3.10	3.20	0.118	0.122	0.126
c	0.59	0.62	0.66	0.023	0.024	0.026
D	20.90	21.00	21.10	0.823	0.827	0.831
D1	16.25	16.55	16.85	0.640	0.652	0.663
D2	5.00 TYP			0.197 TYP		
D3	1.05	1.20	1.35	0.041	0.047	0.053
e	5.44 BSC			0.214 BSC		
E	15.70	15.80	15.90	0.618	0.622	0.626
E1	13.06	13.26	13.50	0.514	0.522	0.530
E2	2.50 TYP			0.098 TYP		
L	19.72	19.92	20.12	0.776	0.784	0.792
L1	---	---	4.30	---	---	0.169
Q	6.15 BSC			0.242 BSC		
Q1	5.60	5.80	6.00	0.220	0.228	0.236
ØP	3.55	3.60	3.70	0.140	0.142	0.146

Disclaimer

United Silicon Carbide, Inc. reserves the right to change or modify any of the products and their inherent physical and technical specifications without prior notice. United Silicon Carbide, Inc. assumes no responsibility or liability for any errors or inaccuracies within.

Information on all products and contained herein is intended for description only. No license, express or implied, to any intellectual property rights is granted within this document.

United Silicon Carbide, Inc. assumes no liability whatsoever relating to the choice, selection or use of the United Silicon Carbide, Inc. products and services described herein.