

NDP6051 / NDB6051 N-Channel Enhancement Mode Field Effect Transistor

General Description

These N-Channel enhancement mode power field effect transistors are produced using Fairchild's proprietary, high cell density, DMOS technology. This very high density process has been especially tailored to minimize on-state resistance, provide superior switching performance, and withstand high energy pulses in the avalanche and commutation modes. These devices are particularly suited for low voltage applications such as automotive, DC/DC converters, PWM motor controls, and other battery powered circuits where fast switching, low in-line power loss, and resistance to transients are needed.

Features

- 48 A, 50 V. $R_{DS(ON)} = 0.022 \Omega @ V_{GS} = 10 \text{ V}$.
- Critical DC electrical parameters specified at elevated temperature.
- Rugged internal source-drain diode can eliminate the need for an external Zener diode transient suppressor.
- 175°C maximum junction temperature rating.
- High density cell design for extremely low $R_{DS(ON)}$.
- TO-220 and TO-263 (D²PAK) package for both through hole and surface mount applications.

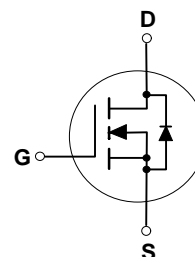
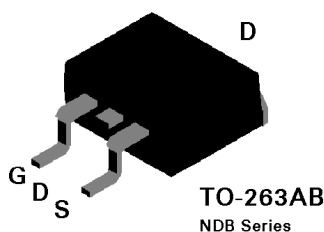
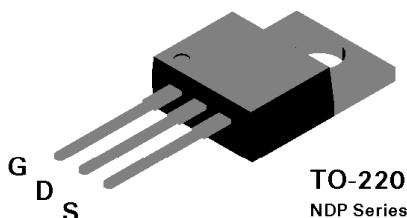

Absolute Maximum Ratings $T_C = 25^\circ\text{C}$ unless otherwise noted

Symbol	Parameter	NDP6051	NDB6051	Units
V_{DSS}	Drain-Source Voltage	50		V
V_{DGR}	Drain-Gate Voltage ($R_{GS} \leq 1 \text{ M}\Omega$)	50		V
V_{GSS}	Gate-Source Voltage - Continuous	± 20		V
	- Nonrepetitive ($t_p < 50 \mu\text{s}$)	± 40		
I_D	Drain Current - Continuous	48		A
	- Pulsed	144		
P_D	Total Power Dissipation @ $T_C = 25^\circ\text{C}$	100		W
	Derate above 25°C	0.67		
T_J, T_{STG}	Operating and Storage Temperature Range	-65 to 175		$^\circ\text{C}$
T_L	Maximum lead temperature for soldering purposes, 1/8" from case for 5 seconds	275		$^\circ\text{C}$

Electrical Characteristics (T _c = 25°C unless otherwise noted)						
Symbol	Parameter	Conditions	Min	Typ	Max	Units
DRAIN-SOURCE AVALANCHE RATINGS (Note 1)						
W _{DSS}	Single Pulse Drain-Source Avalanche Energy	V _{DD} = 25 V, I _D = 48 A			300	mJ
I _{AR}	Maximum Drain-Source Avalanche Current				48	A
OFF CHARACTERISTICS						
BV _{DSS}	Drain-Source Breakdown Voltage	V _{GS} = 0 V, I _D = 250 μA	50			V
I _{DSS}	Zero Gate Voltage Drain Current	V _{DS} = 50 V, V _{GS} = 0 V			250	μA
		T _J = 125°C			1	mA
I _{GSSF}	Gate - Body Leakage, Forward	V _{GS} = 20 V, V _{DS} = 0 V			100	nA
I _{GSSR}	Gate - Body Leakage, Reverse	V _{GS} = -20 V, V _{DS} = 0 V			-100	nA
ON CHARACTERISTICS (Note 1)						
V _{GS(th)}	Gate Threshold Voltage	V _{DS} = V _{GS} , I _D = 250 μA	2	2.8	4	V
		T _J = 125°C	1.4	2.2	3.6	
R _{DS(on)}	Static Drain-Source On-Resistance	V _{GS} = 10 V, I _D = 24 A		0.018	0.022	Ω
		T _J = 125°C		0.03	0.04	
I _{D(on)}	On-State Drain Current	V _{GS} = 10 V, V _{DS} = 10 V	60			A
g _{FS}	Forward Transconductance	V _{DS} = 10 V, I _D = 24 A		14		S
DYNAMIC CHARACTERISTICS						
C _{ISS}	Input Capacitance	V _{DS} = 25 V, V _{GS} = 0 V, f = 1.0 MHz		1220		pF
C _{OSS}	Output Capacitance			520		pF
C _{RSS}	Reverse Transfer Capacitance			190		pF
SWITCHING CHARACTERISTICS (Note 1)						
t _{D(on)}	Turn - On Delay Time	V _{DD} = 30 V, I _D = 48 A,		10	20	nS
t _r	Turn - On Rise Time	V _{GS} = 10 V, R _{GEN} = 7.5 Ω		132	250	nS
t _{D(off)}	Turn - Off Delay Time			28	55	nS
t _f	Turn - Off Fall Time			80	150	nS
Q _g	Total Gate Charge	V _{DS} = 24 V,		37	53	nC
Q _{gs}	Gate-Source Charge	I _D = 48 A, V _{GS} = 10V		8		
Q _{gd}	Gate-Drain Charge			22		

Electrical Characteristics ($T_c = 25^\circ\text{C}$ unless otherwise noted)

Symbol	Parameter	Conditions	Min	Typ	Max	Units	
DRAIN-SOURCE DIODE CHARACTERISTICS							
I_s	Maximum Continuous Drain-Source Diode Forward Current				48	A	
I_{SM}	Maximum Pulsed Drain-Source Diode Forward Current				144	A	
V_{SD}	Drain-Source Diode Forward Voltage	$V_{GS} = 0\text{ V}$, $I_S = 24\text{ A}$ (Note 1)			0.9	1.3	V
				$T_J = 125^\circ\text{C}$	0.8	1.2	
t_{rr}	Reverse Recovery Time	$V_{GS} = 0\text{ V}$, $I_F = 48\text{ A}$, $di_F/dt = 100\text{ A}/\mu\text{s}$	35		140	ns	
I_{rr}	Reverse Recovery Current		2		8	A	
THERMAL CHARACTERISTICS							
$R_{\theta JC}$	Thermal Resistance, Junction-to-Case				1.5	$^\circ\text{C}/\text{W}$	
$R_{\theta JA}$	Thermal Resistance, Junction-to-Ambient				62.5	$^\circ\text{C}/\text{W}$	

Note:

1. Pulse Test: Pulse Width $\leq 300\ \mu\text{s}$, Duty Cycle $\leq 2.0\%$.

Typical Electrical Characteristics

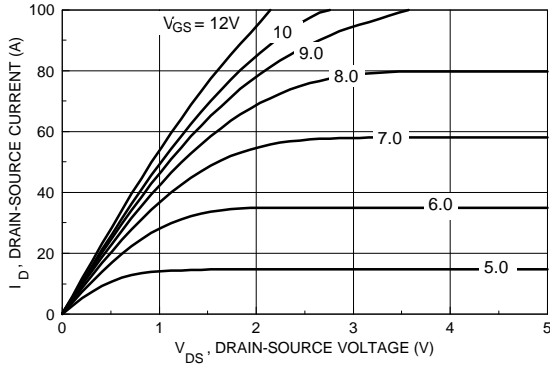

Figure 1. On-Region Characteristics.

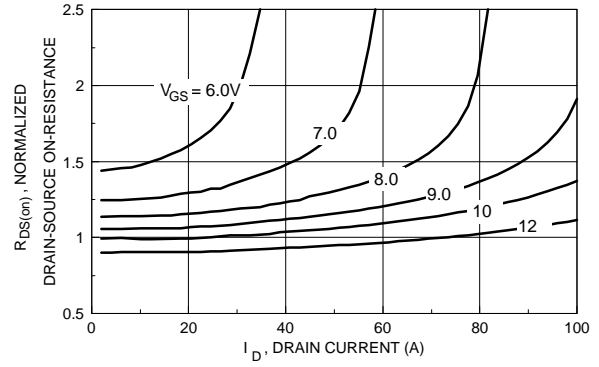

Figure 2. On-Resistance Variation with Gate Voltage and Drain Current.

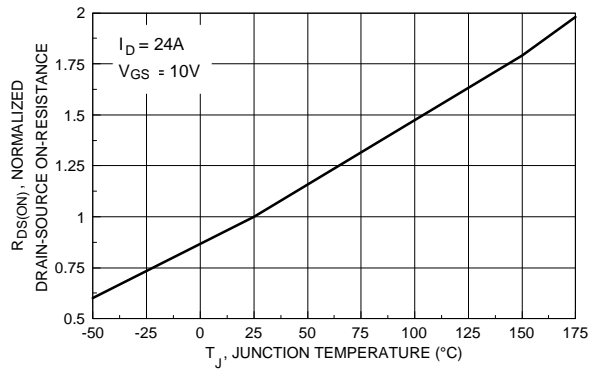

Figure 3. On-Resistance Variation with Temperature.

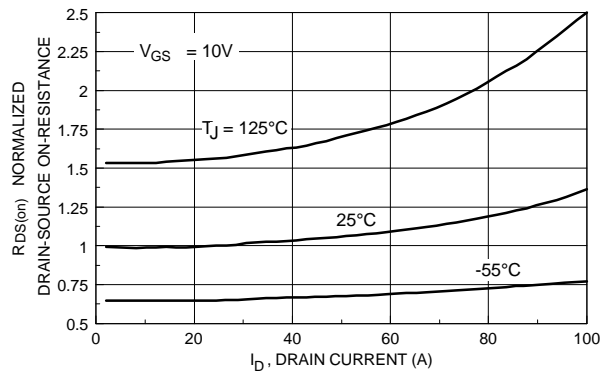

Figure 4. On-Resistance Variation with Drain Current and Temperature.

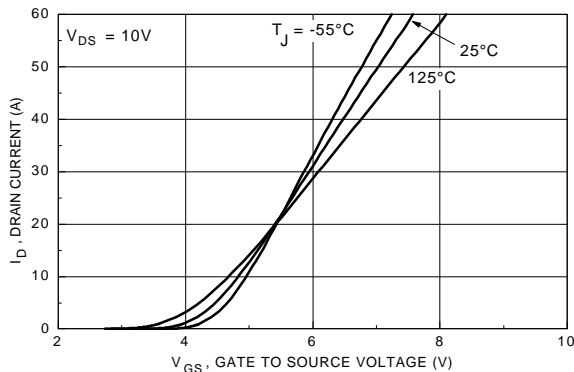

Figure 5. Transfer Characteristics.

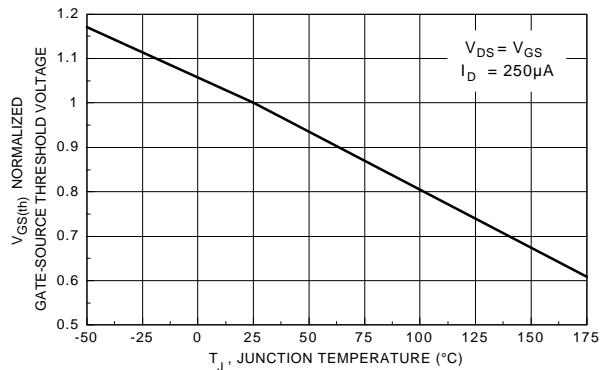

Figure 6. Gate Threshold Variation With Temperature.

Typical Electrical Characteristics (continued)

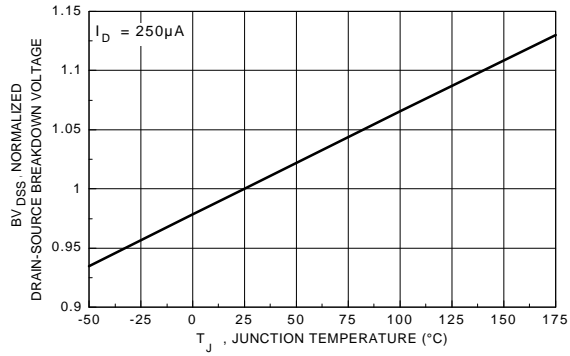

Figure 7. Breakdown Voltage Variation with Temperature.

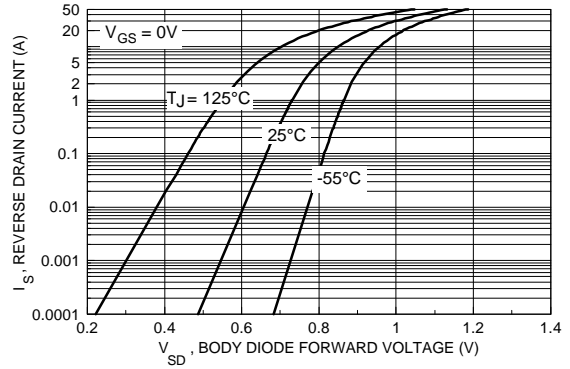

Figure 8. Body Diode Forward Voltage Variation with Current and Temperature.

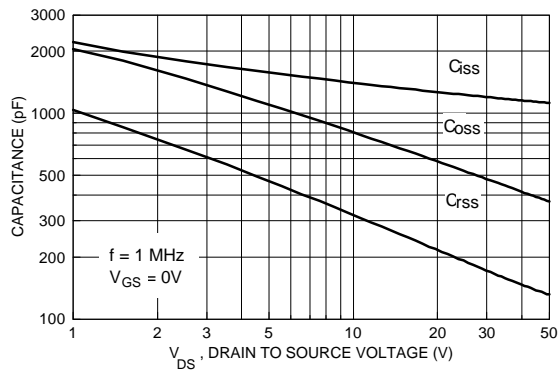

Figure 9. Capacitance Characteristics.

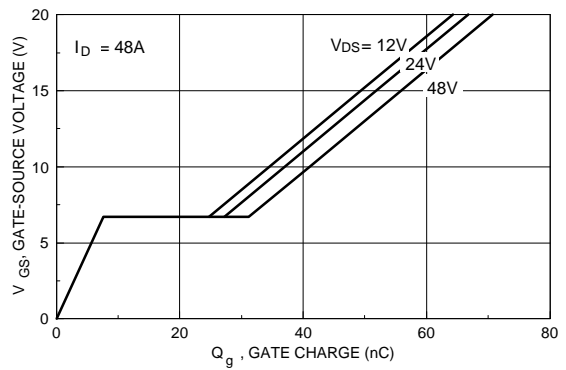

Figure 10. Gate Charge Characteristics.

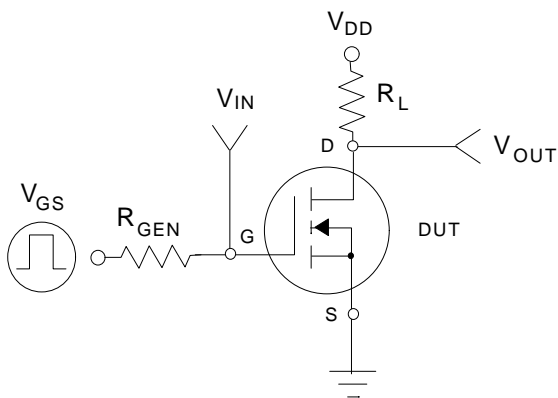

Figure 11. Switching Test Circuit.

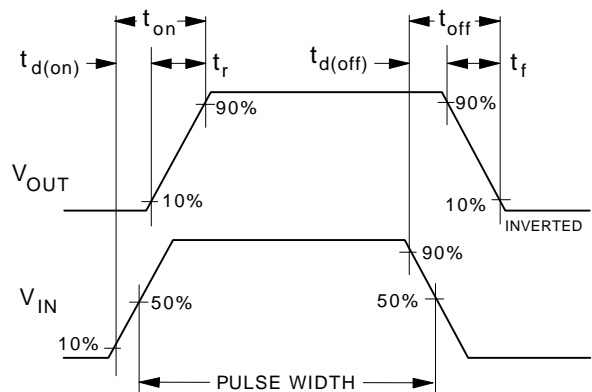

Figure 12. Switching Waveforms.

Typical Electrical Characteristics (continued)

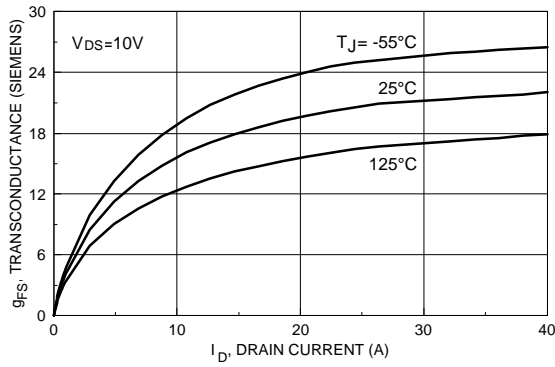

Figure 13. Transconductance Variation with Drain Current and Temperature.

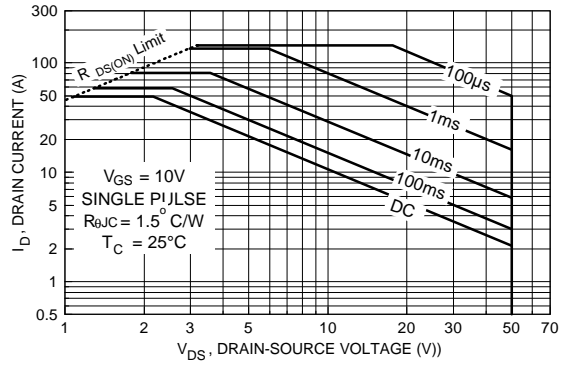

Figure 14. Maximum Safe Operating Area.

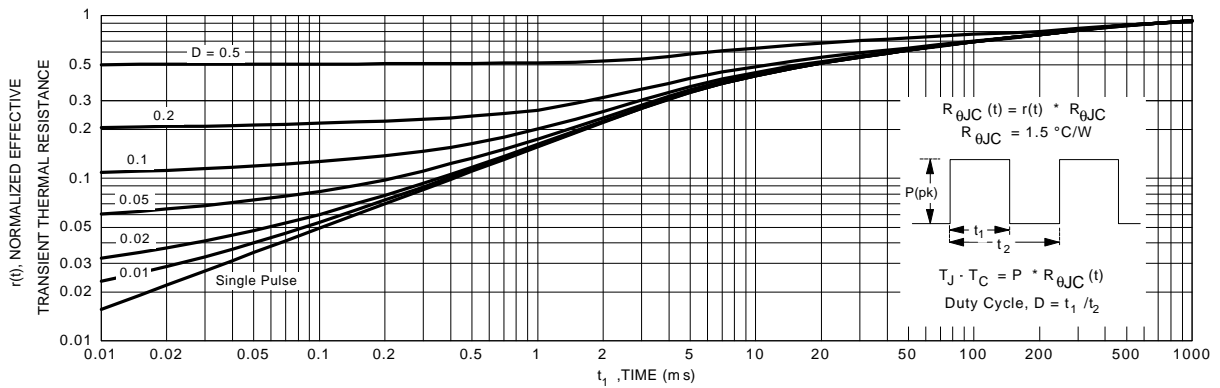

Figure 15. Transient Thermal Response Curve.

This datasheet has been downloaded from:

www.EEworld.com.cn

Free Download

Daily Updated Database

100% Free Datasheet Search Site

100% Free IC Replacement Search Site

Convenient Electronic Dictionary

Fast Search System

www.EEworld.com.cn