

1A, 55V, 0.750 Ohm, Voltage Clamping, Current Limited, N-Channel Power MOSFET

The RLP1N06CLE is an intelligent monolithic power circuit which incorporates a lateral bipolar transistor, resistors, zener diodes, and a PowerMOS transistor. The current limiting of this device allows it to be used safely in circuits where it is anticipated that a shorted load condition may be encountered. The drain to source voltage clamping offers precision control of the circuit voltage when switching inductive loads. Logic level gates allow this device to be fully biased on with only 5V from gate to source. Input protection is provided for ESD up to 2kV.

Formerly developmental type TA09880.

Ordering Information

PART NUMBER	PACKAGE	BRAND
RLP1N06CLE	TO-220AB	L1N06CLE

NOTE: When ordering, use the entire part number.

Features

- 1A, 55V
- $r_{DS(ON)} = 0.750\Omega$
- I_{LIMIT} at 150°C = 1.1A to 1.5A Maximum
- Built-in Voltage Clamp
- Built-in Current Limiting
- ESD Protected, 2kV Minimum
- Controlled Switching Limits EMI and RFI
- 175°C Rated Junction Temperature
- Logic Level Gate
- Related Literature
 - TB334 "Guidelines for Soldering Surface Mount Components to PC Boards"

Symbol

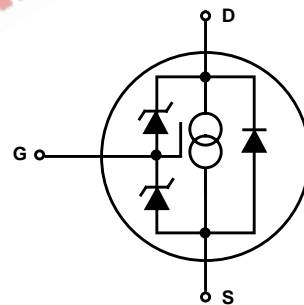

Packaging

JEDEC TO-220AB

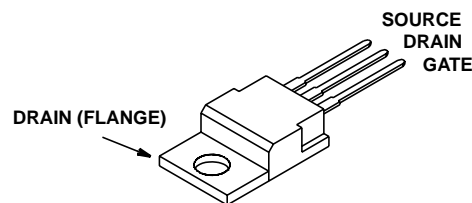

RLP1N06CLE

Absolute Maximum Ratings $T_C = 25^\circ\text{C}$, Unless Otherwise Specified

	RLP1N06CLE	UNITS
Drain to Source Voltage (Note 1)	55	V
Drain to Gate Voltage ($R_{GS} = 20\text{k}\Omega$, Note 1)	55	V
Electrostatic Voltage at $T_C = 25^\circ\text{C}$	2	kV
Continuous Drain Current	Self Limited	
Gate to Source Voltage (Reverse Voltage Gate Bias Not Allowed)	5.5	V
Maximum Power Dissipation	36	W
Power Dissipation Derating	0.24	W/ $^\circ\text{C}$
Operating and Storage Temperature	-55 to 175	$^\circ\text{C}$
Maximum Temperature for Soldering		
Leads at 0.063in (1.6mm) from Case for 10s.	300	$^\circ\text{C}$
Package Body for 10s, See Techbrief 334	260	$^\circ\text{C}$

CAUTION: Stresses above those listed in "Absolute Maximum Ratings" may cause permanent damage to the device. This is a stress only rating and operation of the device at these or any other conditions above those indicated in the operational sections of this specification is not implied.

NOTE:

1. $T_J = 25^\circ\text{C}$ to 150°C .

Electrical Specifications $T_C = 25^\circ\text{C}$, Unless Otherwise Specified

PARAMETER	SYMBOL	TEST CONDITIONS	MIN	TYP	MAX	UNITS	
Drain to Source Breakdown Voltage	BV_{DSS}	$I_D = 20\text{mA}$, $V_{GS} = 0\text{V}$ (Figure 7)	55	-	70	V	
Gate to Threshold Voltage	$V_{GS(TH)}$	$V_{GS} = V_{DS}$, $I_D = 250\mu\text{A}$ (Figure 8)	1	-	2.5	V	
Zero Gate Voltage Drain Current	I_{DSS}	$V_{DS} = 45\text{V}$, $V_{GS} = 0\text{V}$	$T_C = 25^\circ\text{C}$	-	-	5	μA
			$T_C = 150^\circ\text{C}$	-	-	20	μA
Gate to Source Leakage Current	I_{GSS}	$V_{GS} = 5\text{V}$	$T_C = 25^\circ\text{C}$	-	-	5	μA
			$T_C = 150^\circ\text{C}$	-	-	20	μA
Drain to Source On Resistance (Note 2)	$r_{DS(ON)}$	$I_D = 1\text{A}$, $V_{GS} = 5\text{V}$ (Figure 6)	$T_C = 25^\circ\text{C}$	-	-	0.750	Ω
			$T_C = 150^\circ\text{C}$	-	-	1.500	Ω
Limiting Current	$I_{DS(LIM)}$	$V_{DS} = 15\text{V}$, $V_{GS} = 5\text{V}$ (Figure 2)	$T_C = 25^\circ\text{C}$	1.8	-	3	A
			$T_C = 150^\circ\text{C}$	0.9	-	1.5	A
Turn-On Time	$t_{(ON)}$	$V_{DD} = 30\text{V}$, $I_D = 1\text{A}$, $V_{GS} = 5\text{V}$, $R_{GS} = 25\Omega$ $R_L = 30\Omega$	-	-	6.5	μs	
Turn-On Delay Time	$t_{d(ON)}$		-	-	1.5	μs	
Rise Time	t_r		1	-	5	μs	
Turn-Off Delay Time	$t_{d(OFF)}$		-	-	7.5	μs	
Fall Time	t_f		1	-	5	μs	
Turn-Off Time	$t_{(OFF)}$		-	-	12.5	μs	
Thermal Resistance Junction to Case	$R_{\theta JC}$			-	-	4.17	$^\circ\text{C/W}$
Thermal Resistance Junction to Ambient	$R_{\theta JA}$	TO-220AA	-	-	62	$^\circ\text{C/W}$	
Electrostatic Voltage	ESD	Human Model (100pF, 1.5k Ω) MIL-STD-883B (Category B2)	2000	-	-	V	

Source to Drain Diode Specifications

PARAMETER	SYMBOL	TEST CONDITIONS	MIN	TYP	MAX	UNITS
Source to Drain Diode Voltage (Note 2)	V_{SD}	$I_{SD} = 1\text{A}$	-	-	1.5	V
Reverse Recovery Time	t_{rr}	$I_{SD} = 1\text{A}$	-	-	1	ms

NOTES:

2. Pulsed: pulse duration = $80\mu\text{s}$ maximum, duty cycle = 2%.
3. Repetitive rating: pulse width limited by maximum junction temperature.

RLP1N06CLE

Typical Performance Curves Unless Otherwise Specified

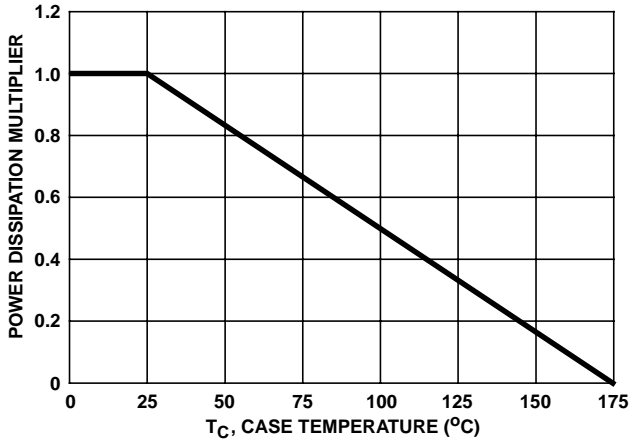

FIGURE 1. NORMALIZED POWER DISSIPATION vs CASE TEMPERATURE

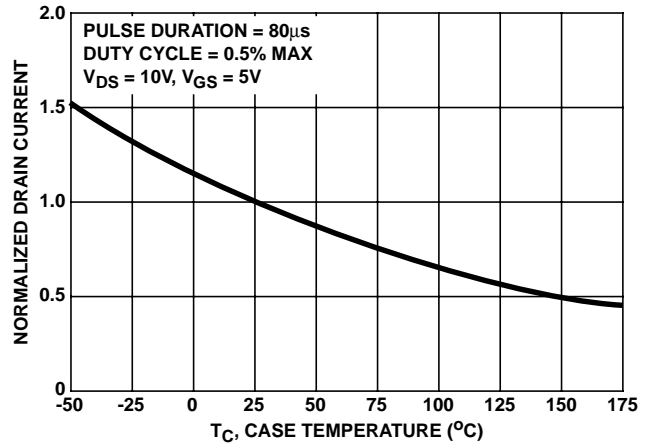

FIGURE 2. NORMALIZED CURRENT LIMIT vs CASE TEMPERATURE

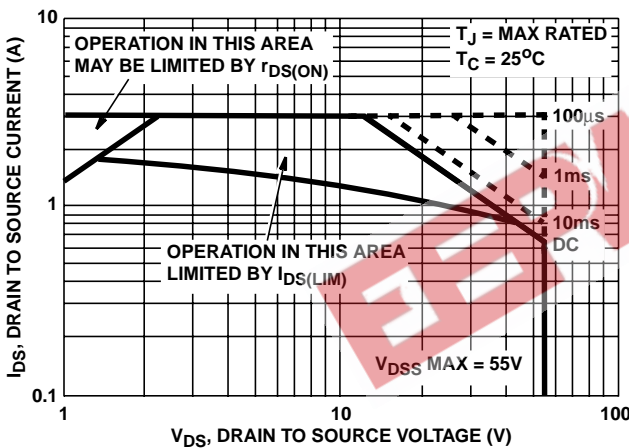

FIGURE 3. FORWARD BIAS SAFE OPERATING AREA

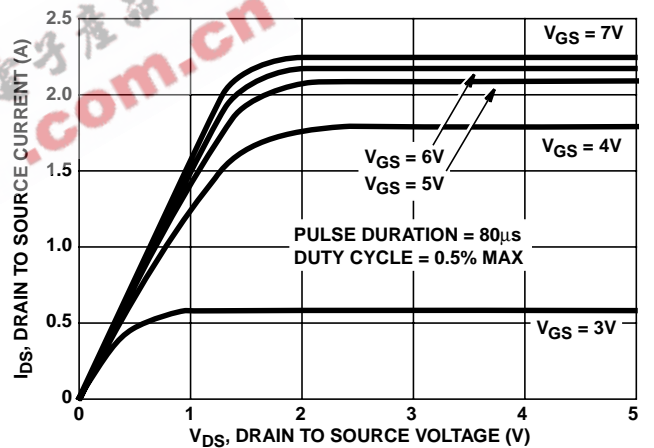

FIGURE 4. SATURATION CHARACTERISTICS

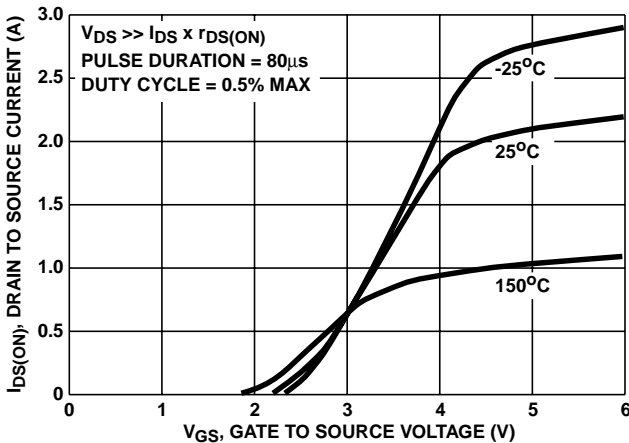

FIGURE 5. TRANSFER CHARACTERISTICS

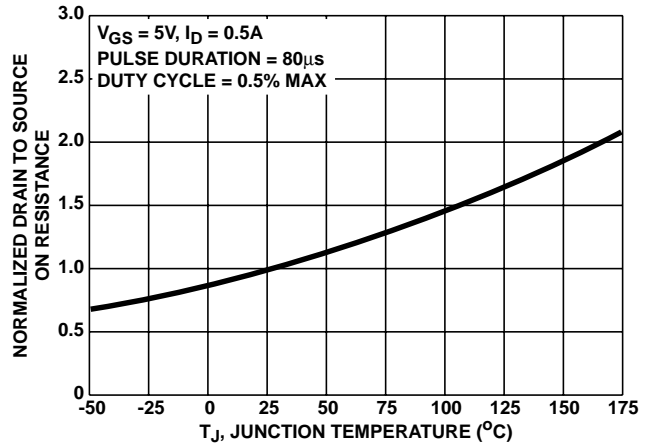

FIGURE 6. NORMALIZED DRAIN TO SOURCE ON RESISTANCE vs JUNCTION TEMPERATURE

Typical Performance Curves Unless Otherwise Specified (Continued)

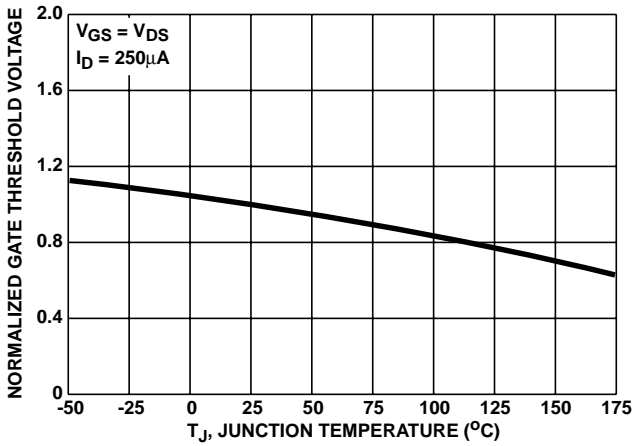

FIGURE 7. NORMALIZED GATE THRESHOLD VOLTAGE vs JUNCTION TEMPERATURE

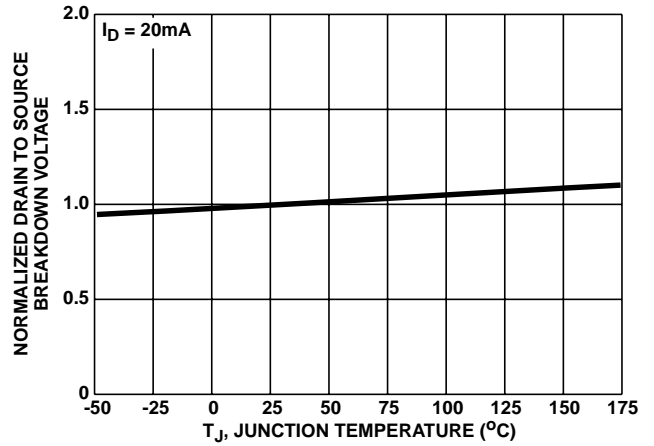

FIGURE 8. NORMALIZED DRAIN TO SOURCE BREAKDOWN VOLTAGE vs JUNCTION TEMPERATURE

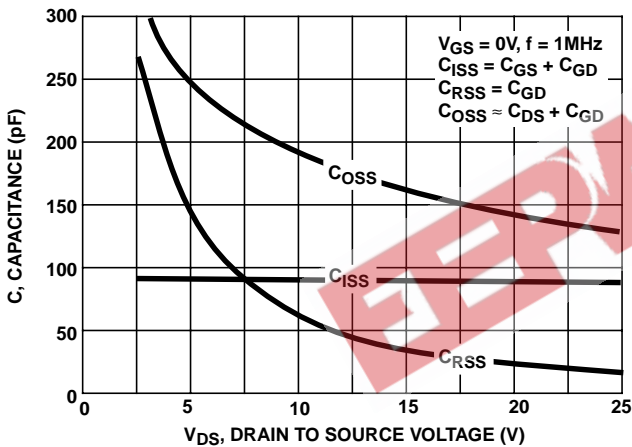

FIGURE 9. CAPACITANCE vs DRAIN TO SOURCE VOLTAGE

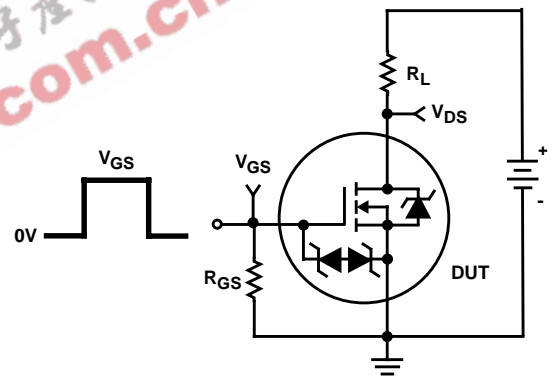

FIGURE 10. SWITCHING TEST CIRCUIT

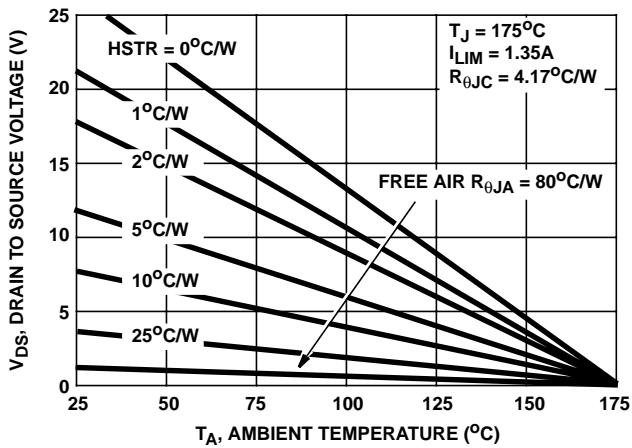
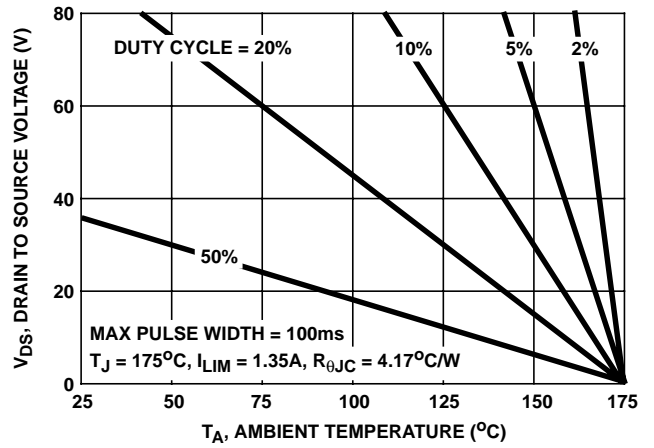

FIGURE 11. DC OPERATION IN CURRENT LIMITING



NOTE: Heatsink thermal resistance = $2^\circ C/W$

FIGURE 12. MAXIMUM V_{DS} vs T_A IN CURRENT LIMITING

RLP1N06CLE

Typical Performance Curves Unless Otherwise Specified (Continued)

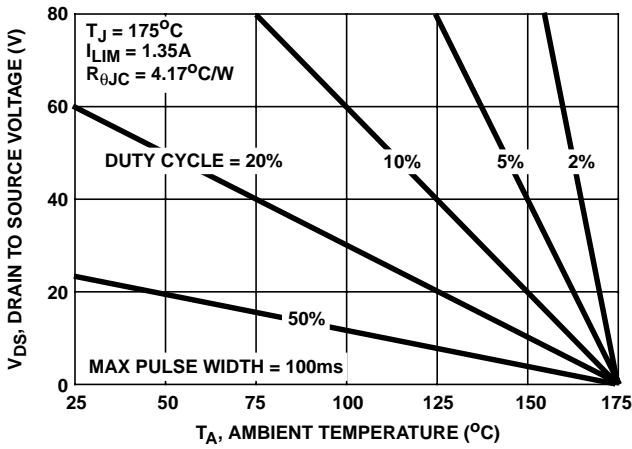

NOTE: Heatsink thermal resistance = 5°C/W

FIGURE 13. MAXIMUM V_{DS} vs T_A IN CURRENT LIMITING

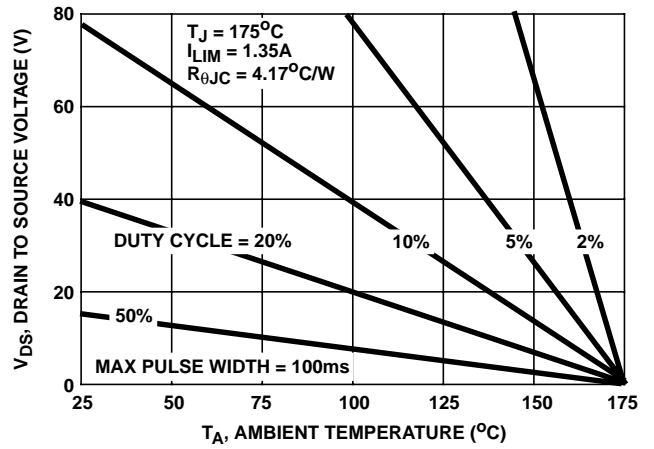

NOTE: Heatsink thermal resistance = 10°C/W

FIGURE 14. MAXIMUM V_{DS} vs T_A IN CURRENT LIMITING

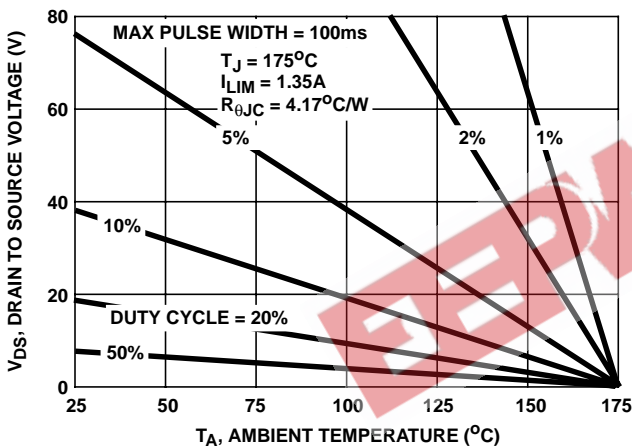

NOTE: Heatsink thermal resistance = 25°C/W

FIGURE 15. MAXIMUM V_{DS} vs T_A IN CURRENT LIMITING

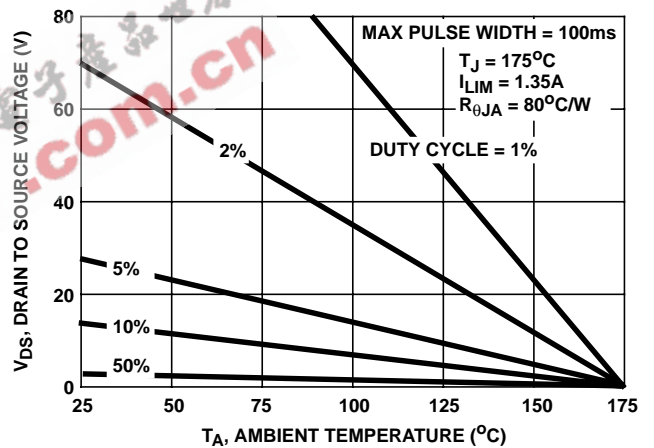

NOTE: No external heatsink

FIGURE 16. MAXIMUM V_{DS} vs T_A IN CURRENT LIMITING

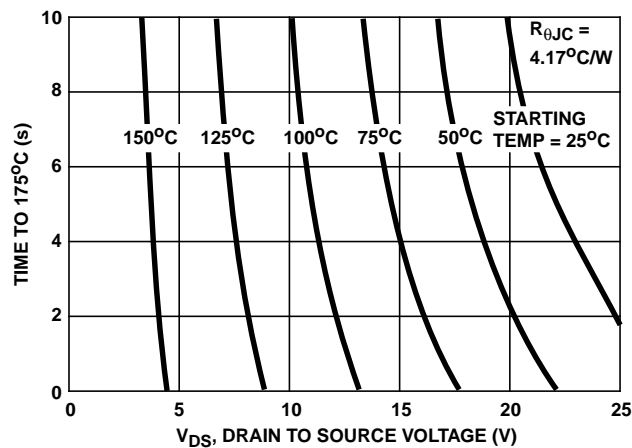

NOTE: Heatsink thermal resistance = 2°C/W
Heatsink thermal capacitance = 4j/°C

FIGURE 17. TIME TO 175°C IN CURRENT LIMITING

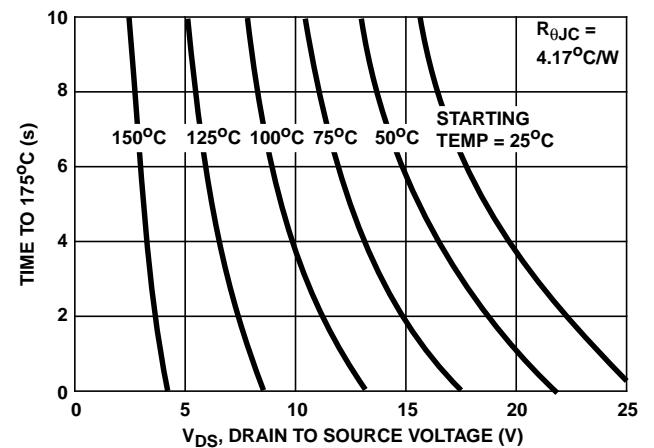

NOTE: Heatsink thermal resistance = 5°C/W
Heatsink thermal capacitance = 2j/°C

FIGURE 18. TIME TO 175°C IN CURRENT LIMITING

Typical Performance Curves Unless Otherwise Specified (Continued)

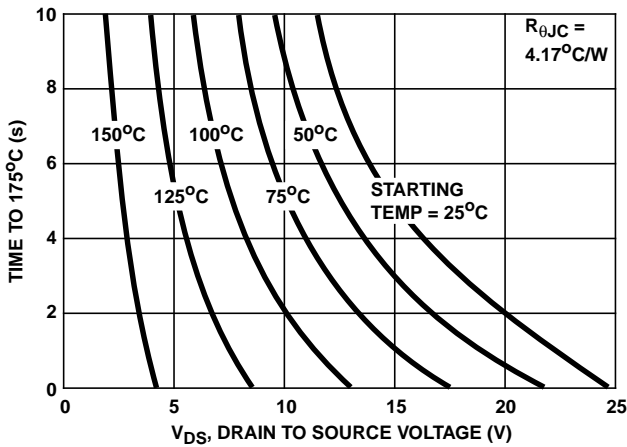

NOTE: Heatsink thermal resistance = 10°C/W
Heatsink thermal capacitance = 1μs/°C

FIGURE 19. TIME TO 175°C IN CURRENT LIMITING

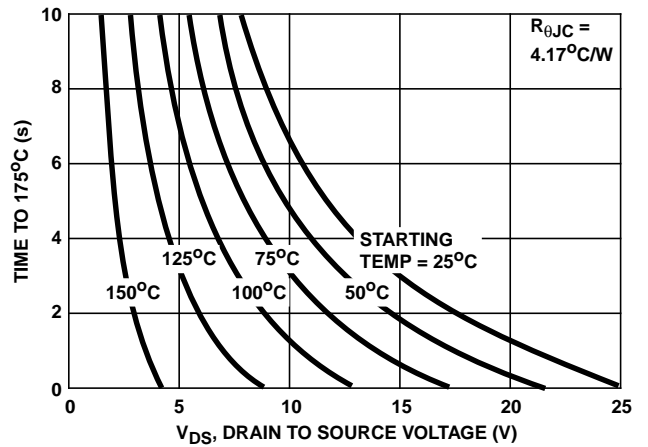

NOTE: Heatsink thermal resistance = 25°C/W
Heatsink thermal capacitance = 0.5μs/°C

FIGURE 20. TIME TO 175°C IN CURRENT LIMITING

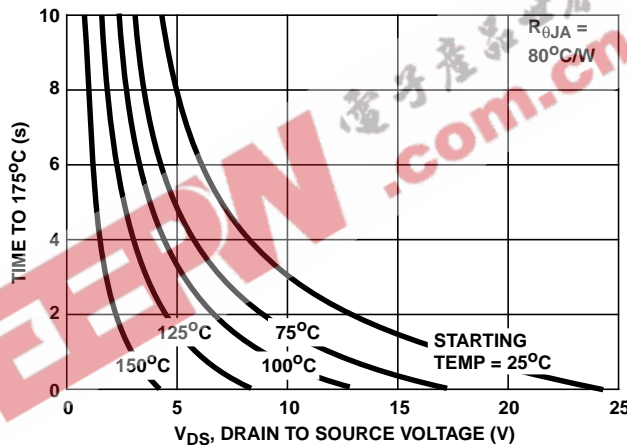

NOTE: No external heatsink

FIGURE 21. TIME TO 175°C IN CURRENT LIMITING

Detailed Description

Temperature Dependence of Current Limiting and Switching Speed

The RLP1N06CLE is a monolithic power device which incorporates a logic level PowerMOS transistor with a resistor in series with the source. The base and emitter of a lateral bipolar transistor is connected across this resistor, and the collector of the bipolar transistor is connected to the gate of the PowerMOS transistor. When the voltage across the resistor reaches the value required to forward bias the emitter base junction of the bipolar transistor, the bipolar transistor “turns on”. A series resistor is incorporated in series with the gate of the PowerMOS transistor allowing the bipolar transistor to drive the gate of the PowerMOS transistors to a voltage which just maintains a constant current in the PowerMOS transistor. Since both the resistance of the resistor

in series with the PowerMOS transistor source and voltage required to forward bias the base emitter junction of the bipolar transistor vary with the temperature, the current at which the device limits is a function of temperature. This dependence is shown in figure 2.

The resistor in series with the gate of the PowerMOS transistor results in much slower switching than in most PowerMOS transistors. This is an advantage where fast switching can cause EMI or RFI. The switching speed is very predictable, and a minimum as well as maximum fall time is given in the device characteristics for this type.

DC Operation of the RLP1N06CLE

The limit of the drain to source voltage for operation in current limiting on a steady state (DC) basis is shown as Figure 11. The dissipation in the device is simply the applied drain to source voltage multiplied by the limiting current. This

RLP1N06CLE

device, like most Power MOSFET devices today, is limited to 175°C. The maximum voltage allowable can, therefore be expressed as:

$$V_{DS} = \frac{(175^{\circ}\text{C} - T_{\text{AMBIENT}})}{I_{\text{LIM}} \times (R_{\theta\text{JC}} + R_{\theta\text{CA}})} \quad (\text{EQ. 1})$$

Duty Cycle Operation of the RLP1N06CLE

In many applications either the drain to source voltage or the gate drive is not available 100% of the time. The copper header on which the RLP1N06CLE is mounted has a very large thermal storage capability, so for pulse widths of less than 100 milliseconds, the temperature of the header can be considered a constant case temperature calculated simply as:

$$T_{\text{C}} = (V_{\text{DS}} \times I_{\text{D}} \times D \times R_{\theta\text{CA}}) + T_{\text{AMBIENT}} \quad (\text{EQ. 2})$$

Generally the heat storage capability of the silicon chip in a power transistor is ignored for duty cycle calculations. Making this assumption, limiting junction temperature to 175°C and using the T_{C} calculated above, the expression for maximum V_{DS} under duty cycle operation is:

$$V_{\text{DS}} = \frac{175 - T_{\text{C}}}{I_{\text{LIM}} \times D \times R_{\theta\text{JC}}} \quad (\text{EQ. 3})$$

These values are plotted as Figures 12 thru 16.

Limited Time Operations of the RLP1N06CLE

Protection for a limited period of time is sufficient for many applications. As stated above the heat storage in the silicon chip can usually be ignored for computations of over 10 milliseconds and the thermal equivalent circuit reduces to a simple enough circuit to allow easy computation on the limiting conditions. The variation in limiting current with temperature complicates the calculation of junction temperature, but a simple straight line approximation of the variation is accurate enough to allow meaningful computations. The curves shown as figures 17 thru 21 give an accurate indication of how long the specified voltage can be applied to the device in the current limiting mode without exceeding the maximum specified 175°C junction temperature. In practice this tells you how long you have to alleviate the condition causing the current limiting to occur.

EEPW 电子产品世界 .com.cn

All Intersil semiconductor products are manufactured, assembled and tested under **ISO9000** quality systems certification.

Intersil semiconductor products are sold by description only. Intersil Corporation reserves the right to make changes in circuit design and/or specifications at any time without notice. Accordingly, the reader is cautioned to verify that data sheets are current before placing orders. Information furnished by Intersil is believed to be accurate and reliable. However, no responsibility is assumed by Intersil or its subsidiaries for its use; nor for any infringements of patents or other rights of third parties which may result from its use. No license is granted by implication or otherwise under any patent or patent rights of Intersil or its subsidiaries.

For information regarding Intersil Corporation and its products, see web site <http://www.intersil.com>

Sales Office Headquarters

NORTH AMERICA

Intersil Corporation
P. O. Box 883, Mail Stop 53-204
Melbourne, FL 32902
TEL: (407) 724-7000
FAX: (407) 724-7240

EUROPE

Intersil SA
Mercure Center
100, Rue de la Fusee
1130 Brussels, Belgium
TEL: (32) 2.724.2111
FAX: (32) 2.724.22.05

ASIA

Intersil (Taiwan) Ltd.
7F-6, No. 101 Fu Hsing North Road
Taipei, Taiwan
Republic of China
TEL: (886) 2 2716 9310
FAX: (886) 2 2715 3029