

Features

- 70V/4A,
 $R_{DS(ON)} = 80m\Omega$ (Typ.) @ $V_{GS} = 10V$
 $R_{DS(ON)} = 90m\Omega$ (Typ.) @ $V_{GS} = 4.5V$
- ESD Protected
- Reliable and Rugged
- Ultra Low On-Resistance
- Lead Free and Green Available

Applications

- Power Management
- DC-DC Converter

Pin Description

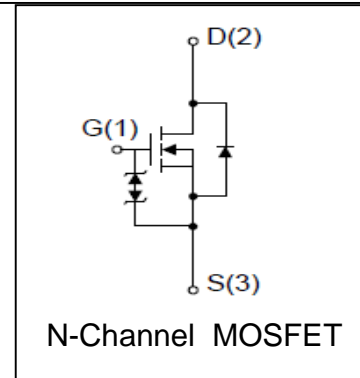
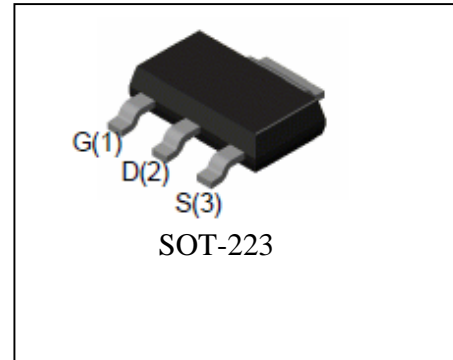

Absolute Maximum Ratings

Symbol	Parameter	Rating	Unit
Common Ratings ($T_A = 25^\circ C$ Unless Otherwise Noted)			
V_{DSS}	Drain-Source Voltage	70	V
V_{GSS}	Gate-Source Voltage	± 20	
T_J	Maximum Junction Temperature	150	$^\circ C$
T_{STG}	Storage Temperature Range	-55 to 150	$^\circ C$
I_S	Diode Continuous Forward Current	$T_A = 25^\circ C$ 4	A
Mounted on Large Heat Sink			
I_{DP}	300 μs Pulse Drain Current Tested	$T_A = 25^\circ C$ 16	A
I_D	Continuous Drain Current ($V_{GS} = 10V$)	$T_A = 25^\circ C$ 4 ^①	A
		$T_A = 70^\circ C$ 3.4	
P_D	Maximum Power Dissipation	$T_A = 25^\circ C$ 2.5	W
		$T_A = 70^\circ C$ 1.6	
$R_{\theta JA}$ ^②	Thermal Resistance-Junction to Ambient	50	$^\circ C/W$

Electrical Characteristics ($T_A=25^{\circ}\text{C}$ Unless Otherwise Noted)

Symbol	Parameter	Test Condition	RU70E4D			Unit
			Min.	Typ.	Max.	
Static Characteristics						
BV_{DSS}	Drain-Source Breakdown Voltage	$V_{GS}=0V, I_{DS}=250\mu A$	70			V
I_{DSS}	Zero Gate Voltage Drain Current	$V_{DS}=70V, V_{GS}=0V$ $T_J=85^{\circ}\text{C}$			1 30	μA
$V_{GS(th)}$	Gate Threshold Voltage	$V_{DS}=V_{GS}, I_{DS}=250\mu A$	1	1.8	2.5	V
I_{GSS}	Gate Leakage Current	$V_{GS}=\pm 16V, V_{DS}=0V$			± 10	μA
$R_{DS(ON)}^{(3)}$	Drain-Source On-state Resistance	$V_{GS}=10V, I_{DS}=4A$		80	100	$m\Omega$
		$V_{GS}=4.5V, I_{DS}=3A$		90	105	$m\Omega$
Diode Characteristics						
$V_{SD}^{(3)}$	Diode Forward Voltage	$I_{SD}=2.5A, V_{GS}=0V$			1.2	V
t_{rr}	Reverse Recovery Time	$I_{SD}=2.5A, di_{SD}/dt=100A/\mu s$		40		ns
Q_{rr}	Reverse Recovery Charge			75		nC
Dynamic Characteristics ⁽⁴⁾						
R_G	Gate Resistance	$V_{GS}=0V, V_{DS}=0V, F=1\text{MHz}$		0.7		Ω
C_{iss}	Input Capacitance	$V_{GS}=0V,$ $V_{DS}=35V,$ Frequency=1.0MHz		460		pF
C_{oss}	Output Capacitance			44		
C_{riss}	Reverse Transfer Capacitance			24		
$t_{d(ON)}$	Turn-on Delay Time	$V_{DD}=35V, R_L=30\Omega,$ $I_{DS}=2.5A, V_{GEN}=10V,$ $R_G=25\Omega$		3		ns
t_r	Turn-on Rise Time			4		
$t_{d(OFF)}$	Turn-off Delay Time			12		
t_f	Turn-off Fall Time			5		
Gate Charge Characteristics ⁽⁴⁾						
Q_g	Total Gate Charge	$V_{DS}=56V, V_{GS}=10V,$ $I_{DS}=2.5A$		16	20	nC
Q_{gs}	Gate-Source Charge			3		
Q_{gd}	Gate-Drain Charge			5		

- Notes: ① Current limited by maximum junction temperature.
 ② When mounted on 1 inch square copper board, $t \leq 10\text{sec}$.
 ③ Pulse test ; Pulse width $\leq 300\mu s$, duty cycle $\leq 2\%$.
 ④ Guaranteed by design, not subject to production testing.

Typical Characteristics

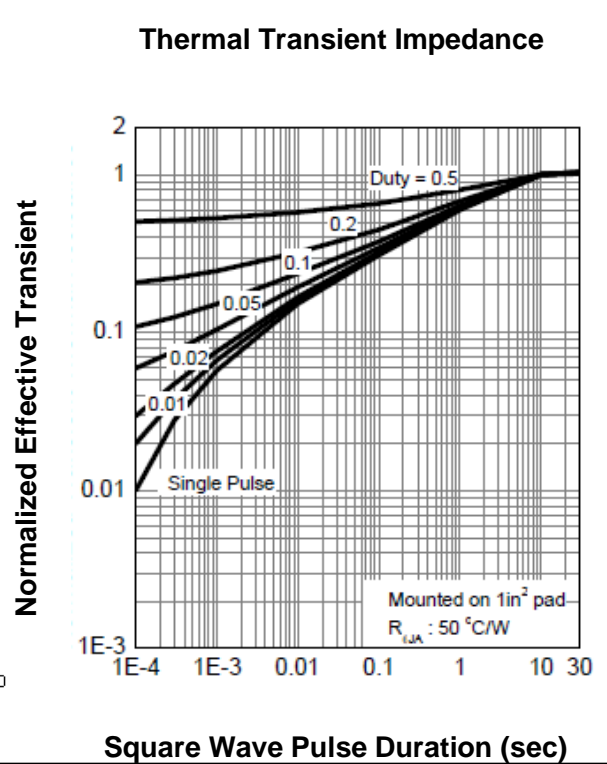
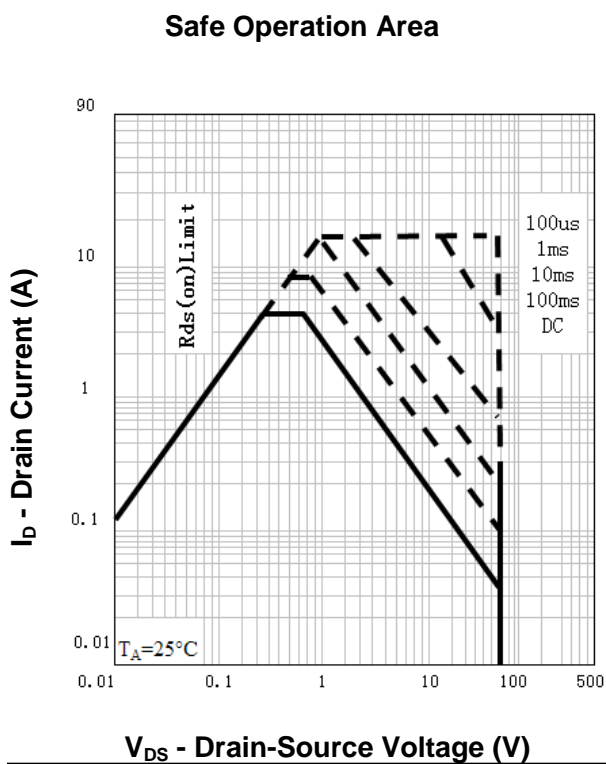
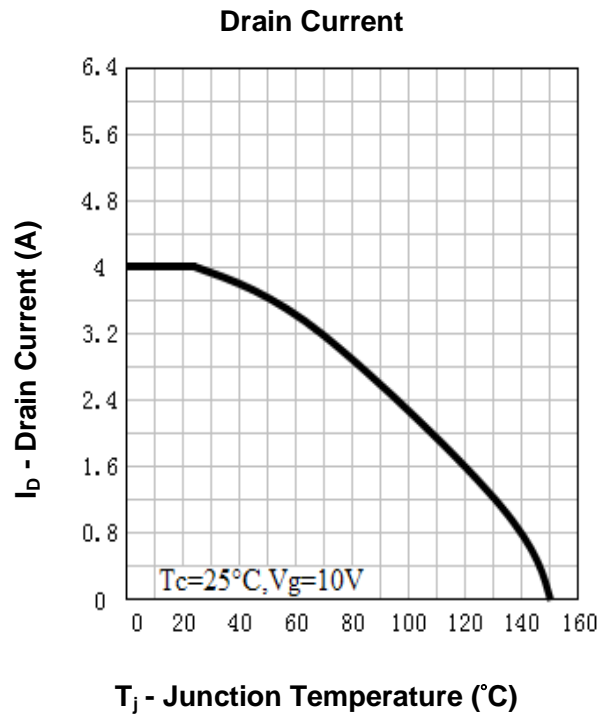
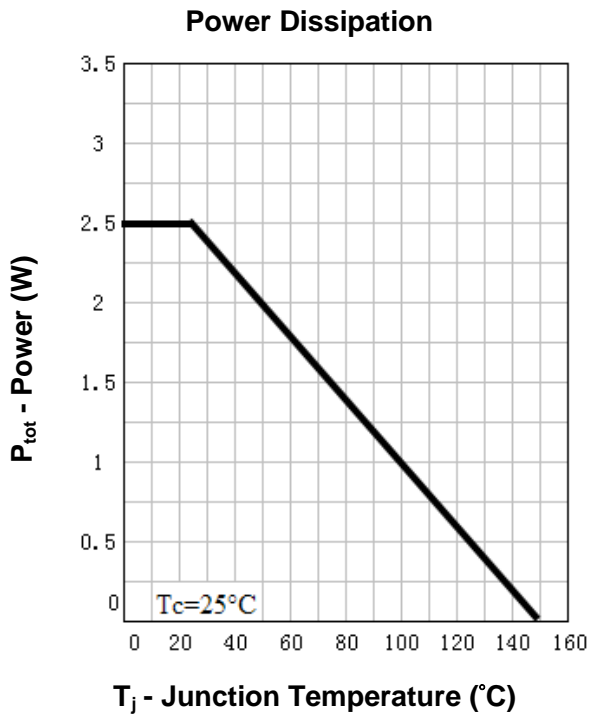

Typical Characteristics

Output Characteristics

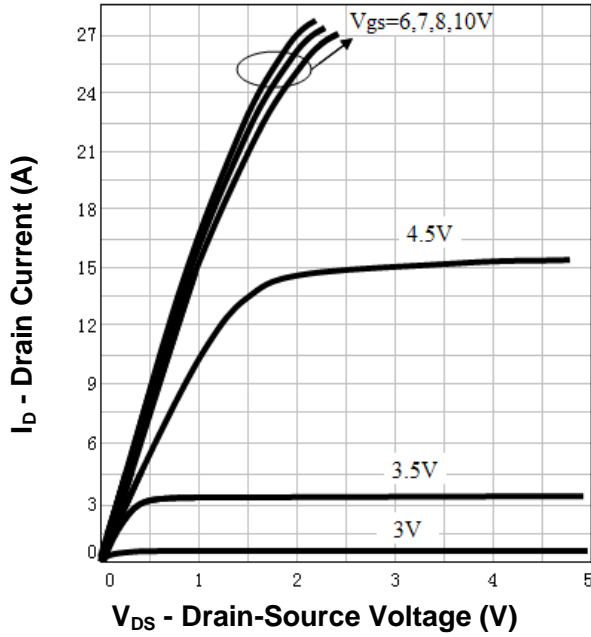

Drain-Source On Resistance

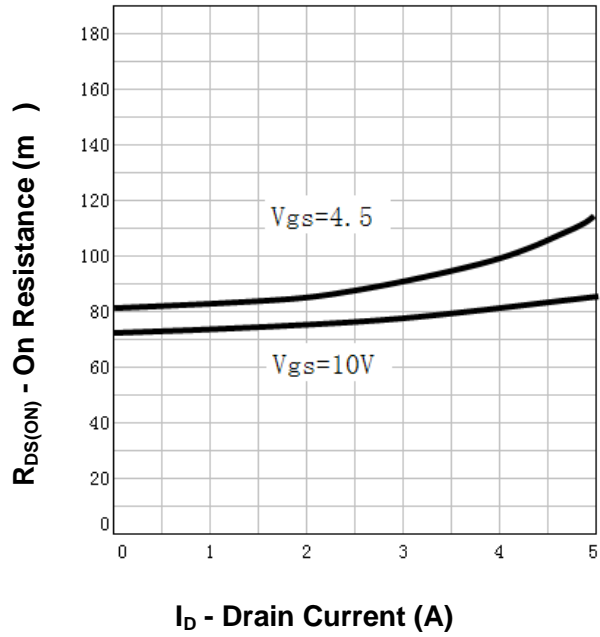

Drain-Source On Resistance

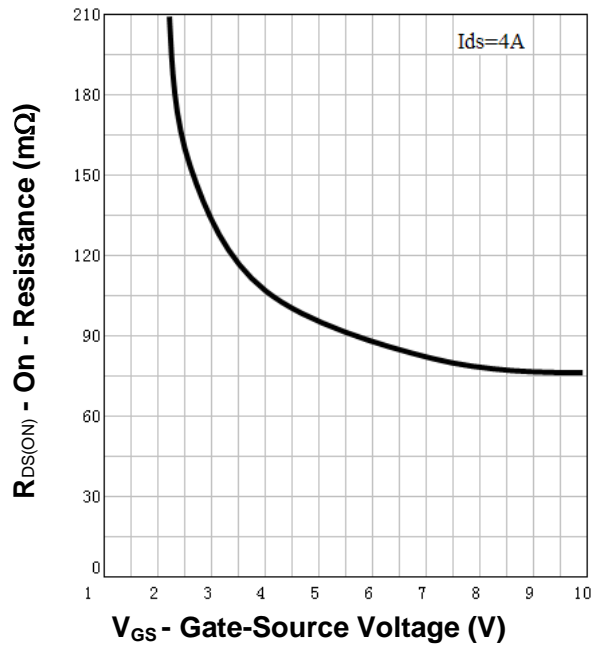

Gate Threshold Voltage

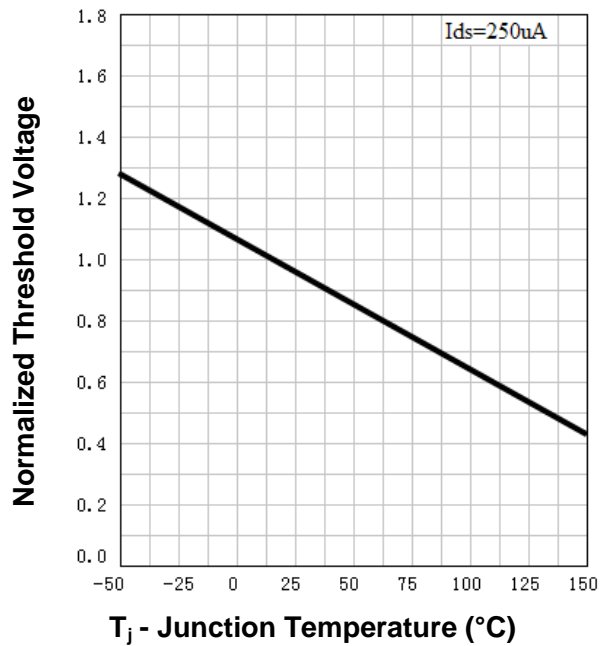

Typical Characteristics

Drain-Source On Resistance

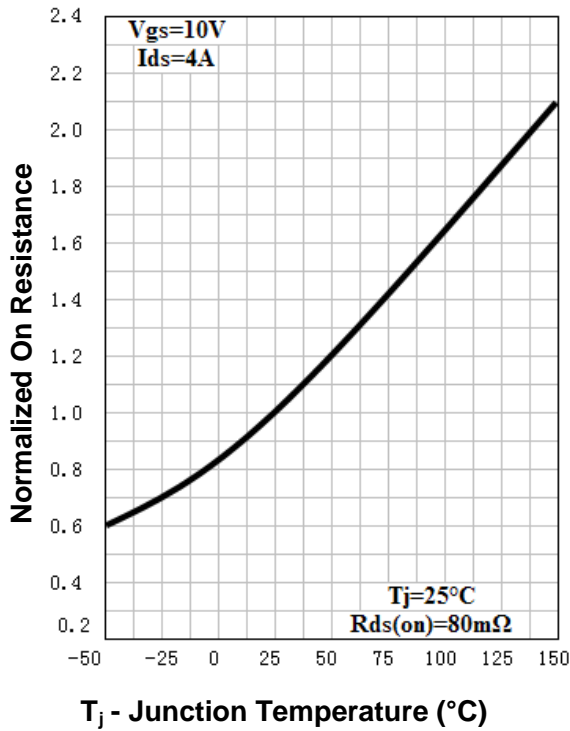

Source-Drain Diode Forward

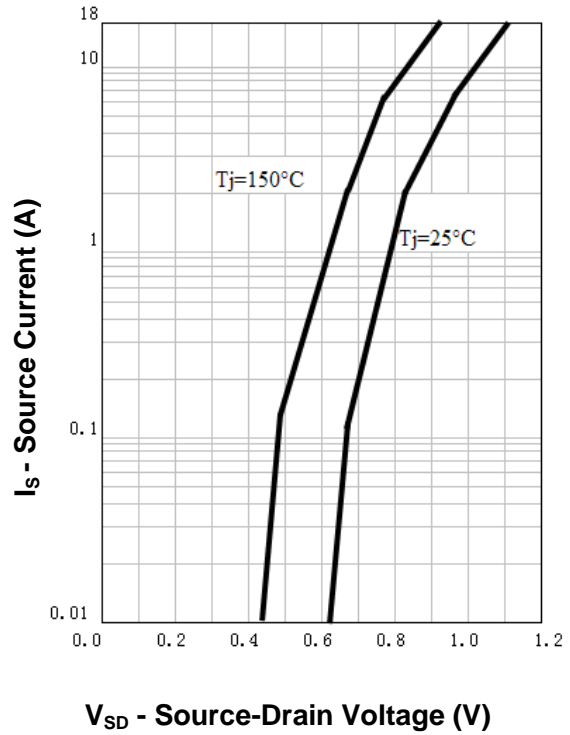

Capacitance

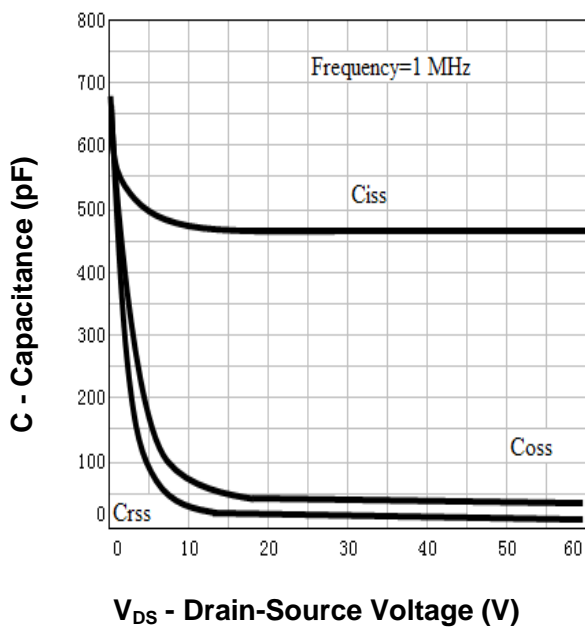

Gate Charge

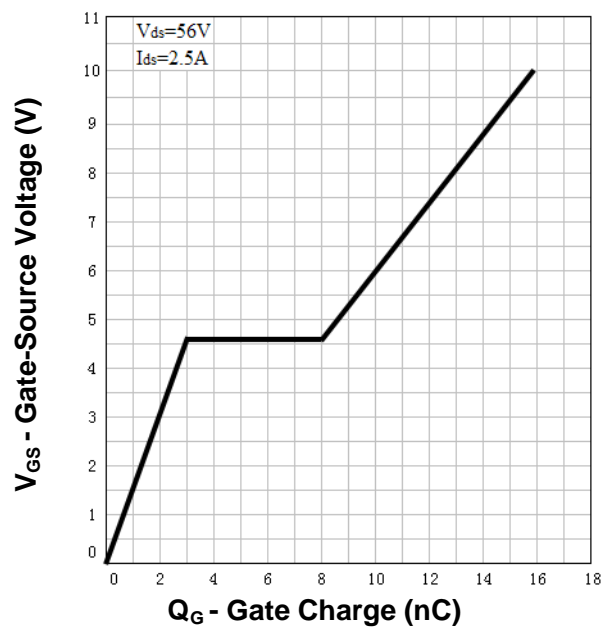

Ordering and Marking Information

Device	Marking	Package	Packaging	Quantity	Reel Size	Tape width
RU70E4D	RU70E4D	SOT-223	Tape&Reel	2500	13''	12mm

Package Information

SOT-223

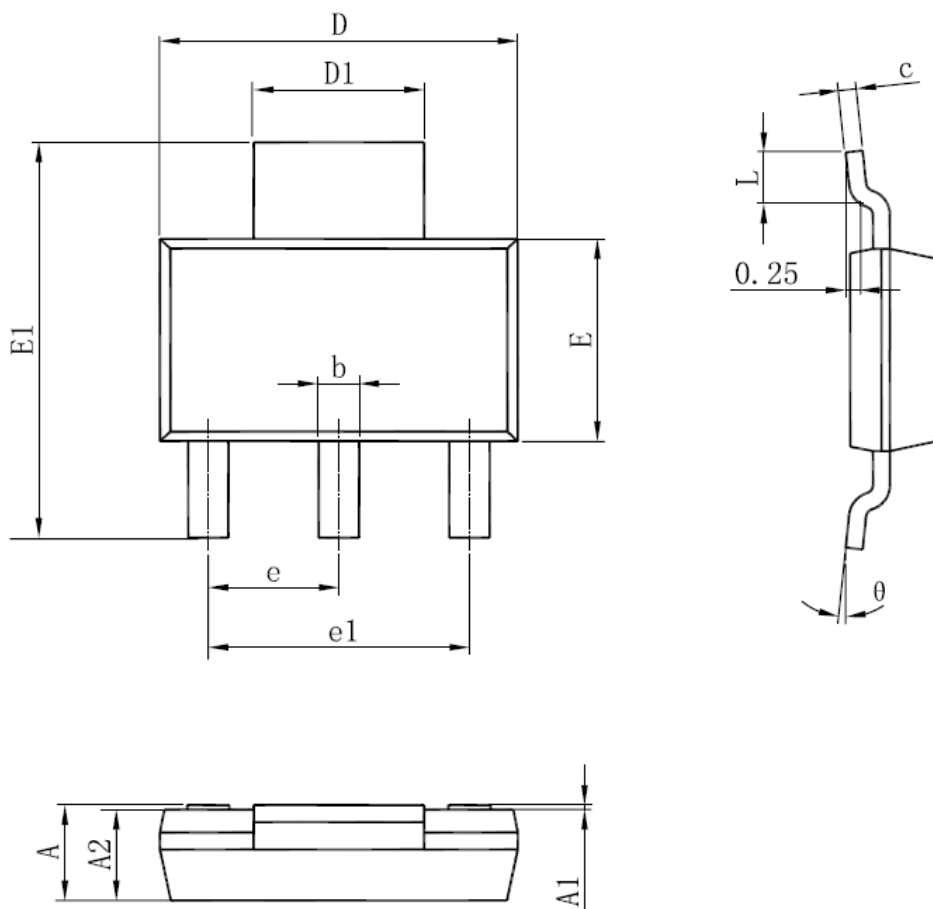

SYMBOL	MM		INCH		SYMBOL	MM		INCH	
	MIN	MAX	MIN	MAX		MIN	MAX	MIN	MAX
A	1.520	1.800	0.060	0.071	E	3.300	3.700	0.130	0.146
A1	0.000	0.100	0.000	0.004	E1	6.830	7.070	0.269	0.278
A2	1.500	1.700	0.059	0.067	e	2.300(BSC)		0.091(BSC)	
b	0.660	0.820	0.026	0.032	e1	4.500	4.700	0.177	0.185
c	0.250	0.350	0.010	0.014	L	0.900	1.150	0.035	0.045
D	6.200	6.400	0.244	0.252	θ	0°	10°	0°	10°
D1	2.900	3.100	0.114	0.122					

ALL DIMENSIONS REFER TO JEDEC STANDARD
DO NOT INCLUDE MOLD FLASH OR PROTRUSIONS

Customer Service

Worldwide Sales and Service:

Sales@ruichips.com

Technical Support:

Technical@ruichips.com

Investor Relations Contacts:

Investor@ruichips.com

Marcom Contact:

Marcom@ruichips.com

Editorial Contact:

Editorial@ruichips.com

HR Contact:

HR@ruichips.com

Legal Contact:

Legal@ruichips.com

Shen Zhen RUICHIPS Semiconductor CO., LTD

Room 501, the 5floor An Tong Industrial Building,
NO.207 Mei Hua Road Fu Tian Area Shen Zhen City, CHINA

TEL: (86-755) 8311-5334

FAX: (86-755) 8311-4278

E-mail: Sales-SZ@ruichips.com