

Features

- 80V/190A
 $R_{DS(ON)}=3.9m\Omega(Typ.) @ V_{GS}=10V$
- Avalanche Rated
- Reliable and Rugged
- Lead Free and Green Devices Available

Applications

- Automotive applications and a wide variety of other applications
- High Efficiency Synchronous in SMPS
- High Speed Power Switching

Pin Description

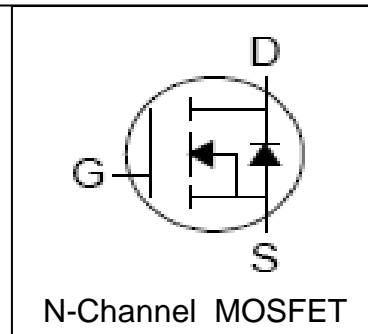
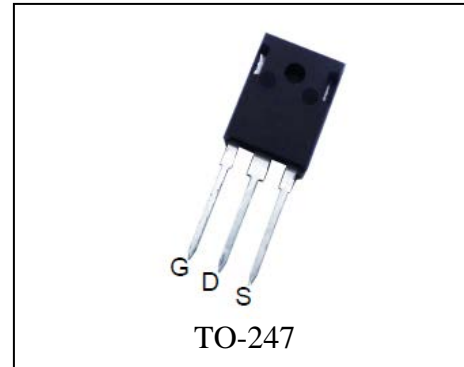

Absolute Maximum Ratings

Symbol	Parameter	Rating	Unit
Common Ratings ($T_A=25^\circ\text{C}$ Unless Otherwise Noted)			
V_{DSS}	Drain-Source Voltage	80	V
V_{GSS}	Gate-Source Voltage	± 25	
T_J	Maximum Junction Temperature	175	$^\circ\text{C}$
T_{STG}	Storage Temperature Range	-55 to 175	$^\circ\text{C}$
I_S	Diode Continuous Forward Current	$T_C=25^\circ\text{C}$ 190 ^①	A
Mounted on Large Heat Sink			
I_{DP}	300 μs Pulsed Drain Current Tested	$T_C=25^\circ\text{C}$ 700 ^②	A
I_D	Continue Drain Current	$T_C=25^\circ\text{C}$ 190 ^①	
		$T_C=100^\circ\text{C}$ 140 ^①	
P_D	Maximum Power Dissipation	$T_C=25^\circ\text{C}$ 326	W
		$T_C=100^\circ\text{C}$ 163	
$R_{\theta JC}$	Thermal Resistance -Junction to Case	0.46	$^\circ\text{C}/\text{W}$
Drain-Source Avalanche Ratings			
E_{AS} ^③	Avalanche Energy ,Single Pulsed	1225	mJ

Electrical Characteristics ($T_A=25^\circ\text{C}$ Unless Otherwise Noted)

Symbol	Parameter	Test Condition	RU190N08Q			Unit
			Min.	Typ.	Max.	
Static Characteristics						
BV_{DSS}	Drain-Source Breakdown Voltage	$V_{GS}=0V, I_{DS}=250\mu A$	80			V
I_{DSS}	Zero Gate Voltage Drain Current	$V_{DS}=80V, V_{GS}=0V$ $T_J=85^\circ\text{C}$			1	μA
					30	
$V_{GS(th)}$	Gate Threshold Voltage	$V_{DS}=V_{GS}, I_{DS}=250\mu A$	2	3	4	V
I_{GSS}	Gate Leakage Current	$V_{GS}=\pm 25V, V_{DS}=0V$			± 100	nA
$R_{DS(ON)}^{(4)}$	Drain-Source On-state Resistance	$V_{GS}=10V, I_{DS}=40A$		3.9	4.8	m Ω
Diode Characteristics						
$V_{SD}^{(4)}$	Diode Forward Voltage	$I_{SD}=40A, V_{GS}=0V$			1.2	V
t_{rr}	Reverse Recovery Time	$I_{SD}=40A, di_{SD}/dt=100A/\mu s$		68		ns
q_{rr}	Reverse Recovery Charge			130		nC
Dynamic Characteristics ⁽⁵⁾						
R_G	Gate Resistance	$V_{GS}=0V, V_{DS}=0V, F=1\text{MHz}$		1.0		Ω
C_{iss}	Input Capacitance	$V_{GS}=0V,$ $V_{DS}=30V,$ Frequency=1.0MHz		6800		pF
C_{oss}	Output Capacitance			1100		
C_{riss}	Reverse Transfer Capacitance			490		
$t_{d(ON)}$	Turn-on Delay Time	$V_{DD}=35V, R_L=35\Omega,$ $I_{DS}=1A, V_{GEN}=10V,$ $R_G=6\Omega$		38		ns
t_r	Turn-on Rise Time			22		
$t_{d(OFF)}$	Turn-off Delay Time			120		
t_f	Turn-off Fall Time			75		
Gate Charge Characteristics ⁽⁵⁾						
Q_g	Total Gate Charge	$V_{DS}=30V, V_{GS}=10V,$ $I_{DS}=40A$		155		nC
Q_{gs}	Gate-Source Charge			45		
Q_{gd}	Gate-Drain Charge			48		

- Notes:
- ① Calculated continuous current based on maximum allowable junction temperature. Package limitation current is 90A.
 - ② Pulse width limited by safe operating area.
 - ③ Limited by $T_{Jmax}, I_{AS}=50A, V_{DD}=48V, R_G=47\Omega$, Starting $T_J=25^\circ\text{C}$.
 - ④ Pulse test; Pulse width $\leq 300\mu s$, duty cycle $\leq 2\%$.
 - ⑤ Guaranteed by design, not subject to production testing.

Typical Characteristics

Power Dissipation

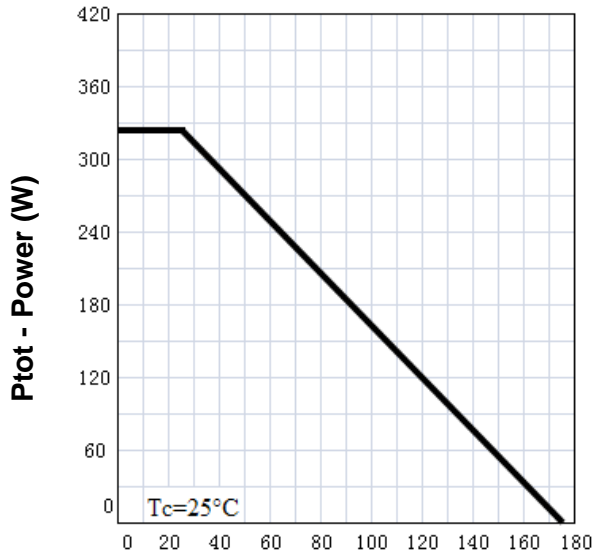

T_j - Junction Temperature (°C)

Drain Current

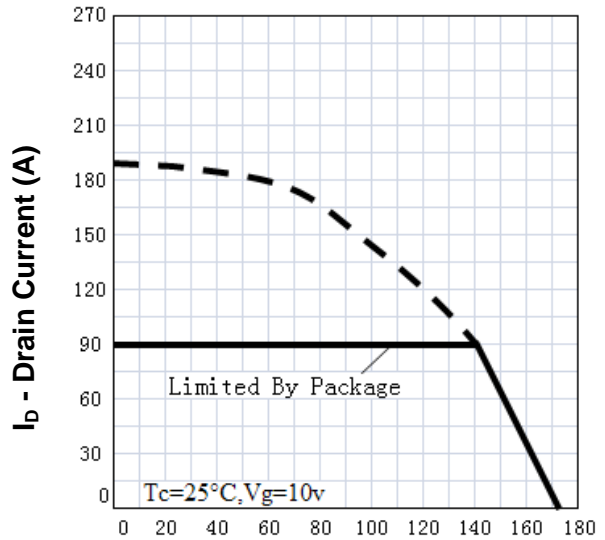

T_j - Junction Temperature (°C)

Safe Operation Area

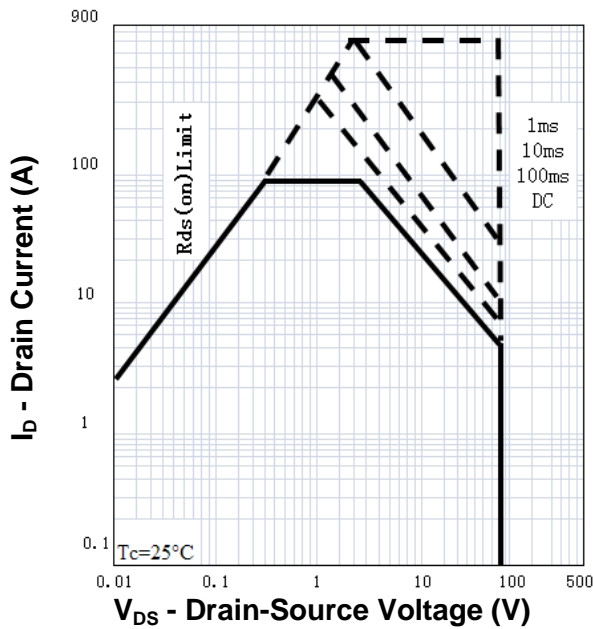

Thermal Transient Impedance

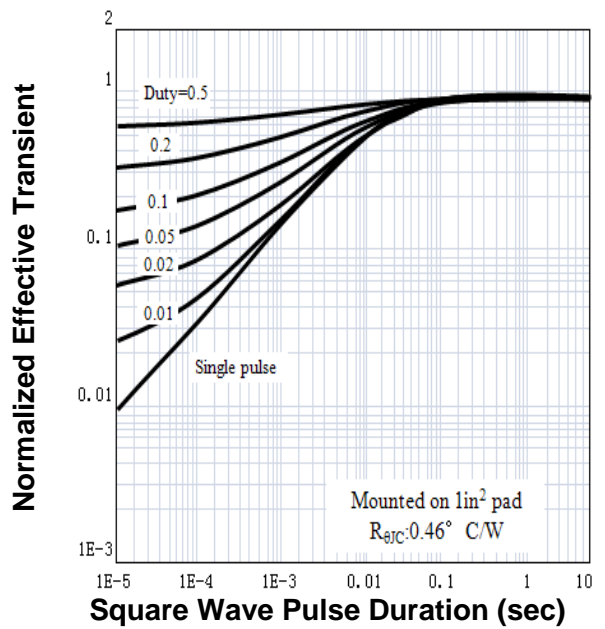

Typical Characteristics

Output Characteristics

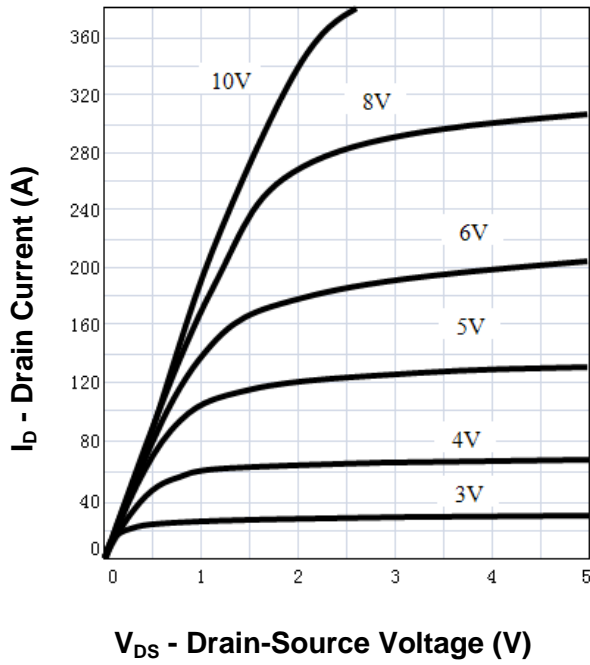

Drain-Source On Resistance

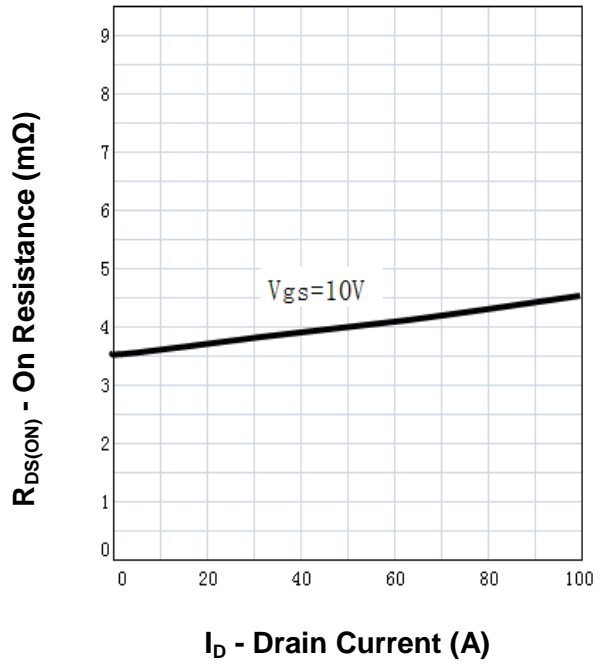

Drain-Source On Resistance

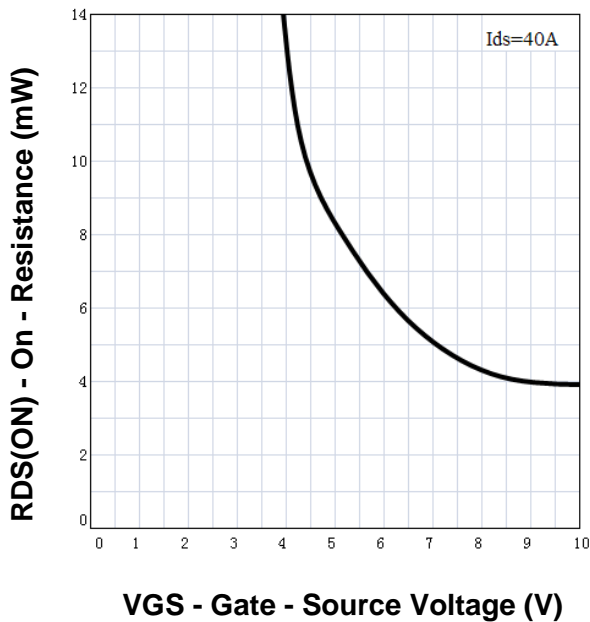

Gate Threshold Voltage

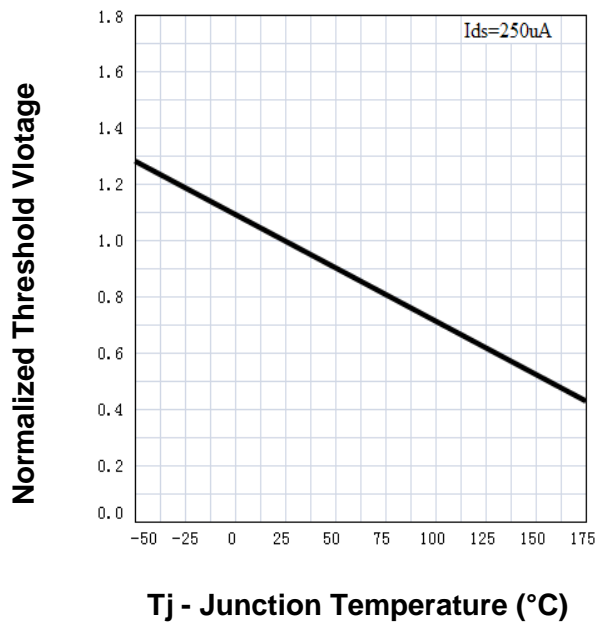

Typical Characteristics

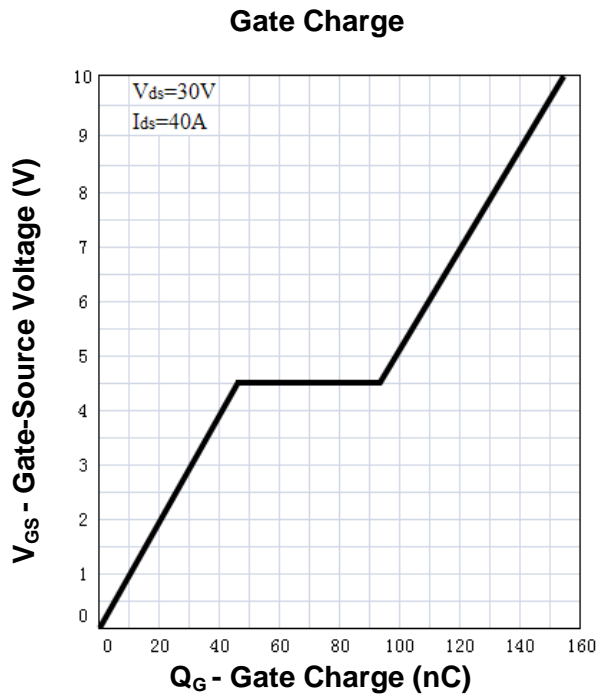
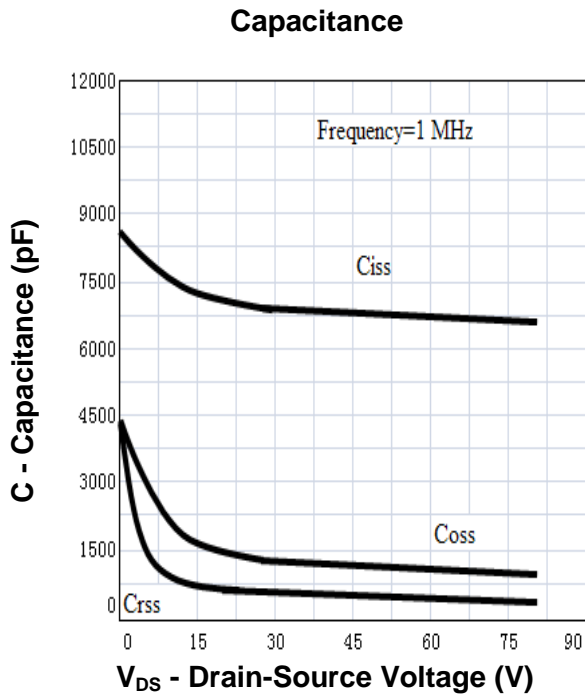
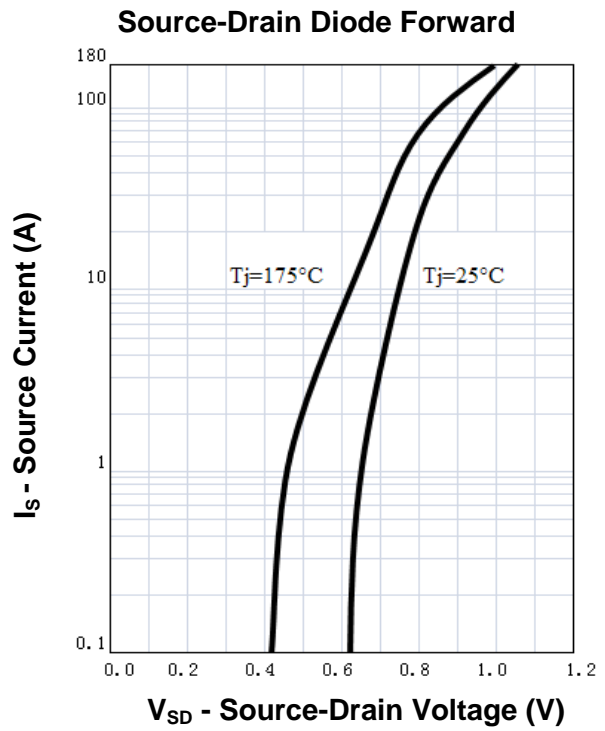
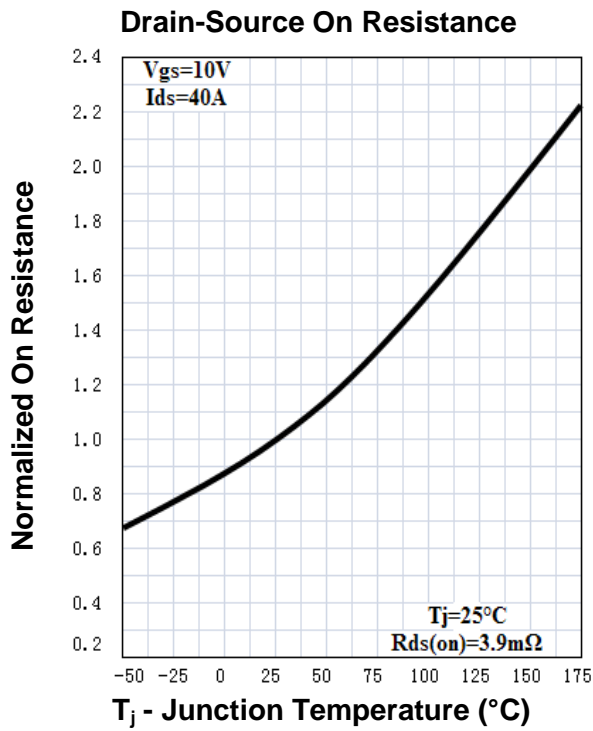

Avalanche Test Circuit and Waveforms

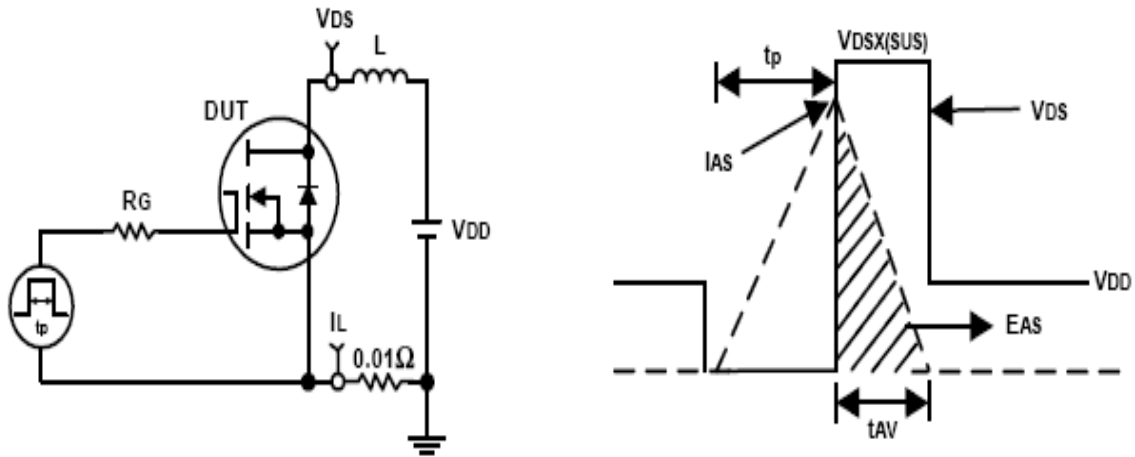

Switching Time Test Circuit and Waveforms

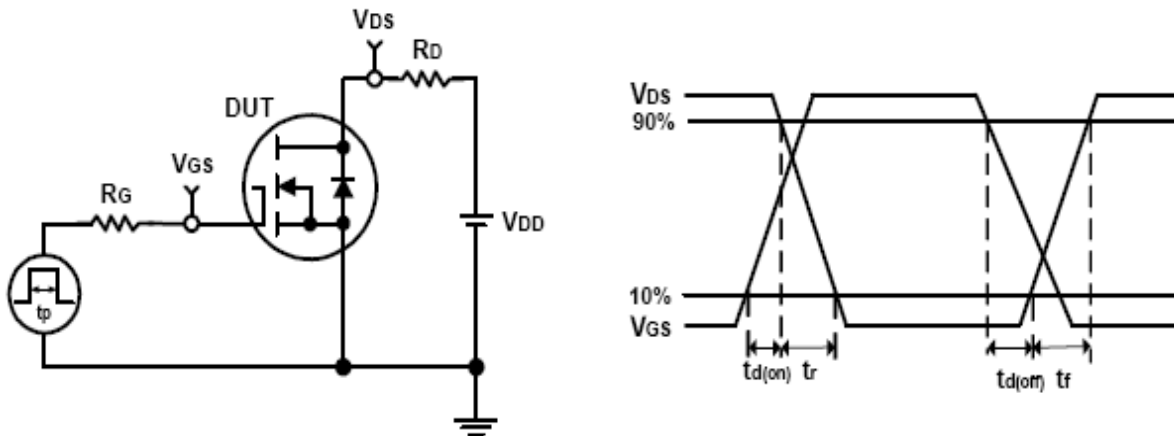

Ordering and Marking Information

Device	Marking	Package	Packaging	Quantity	Reel Size	Tape width
RU190N08Q	RU190N08Q	TO-247	Tube	30	-	-

Package Information

TO-247

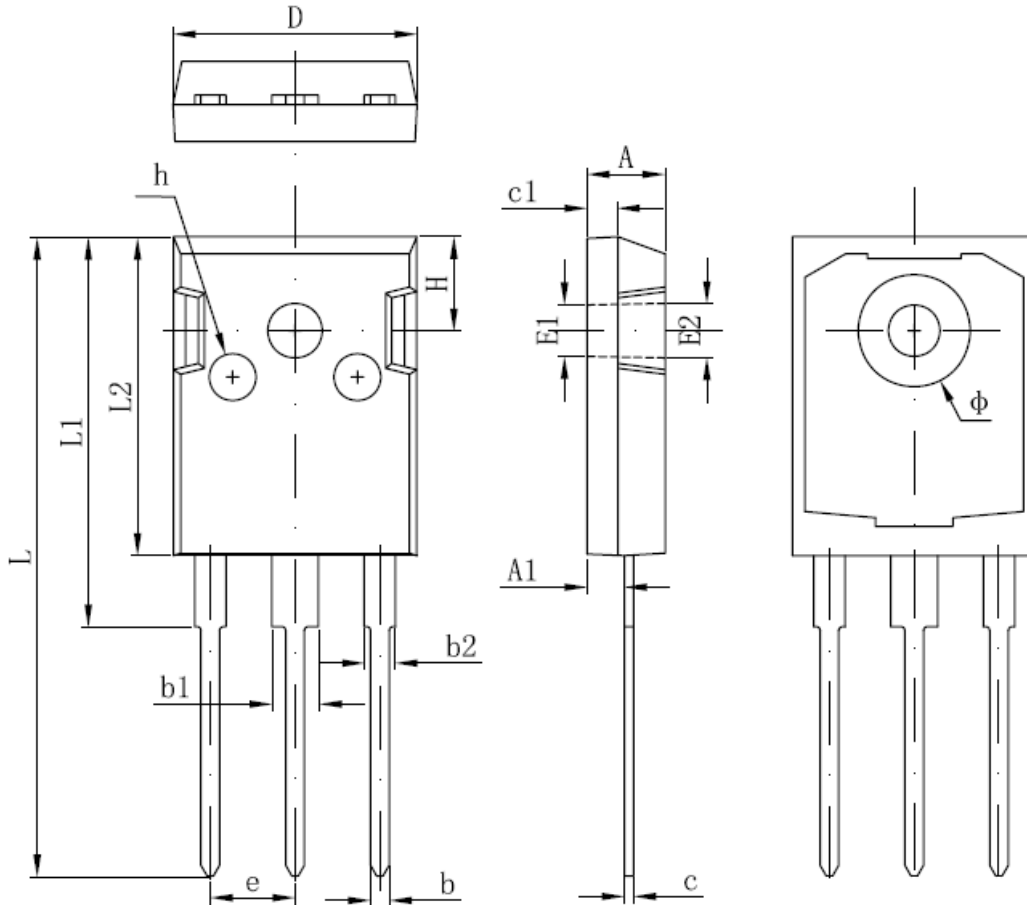

SYMBOL	MM		INCH		SYMBOL	MM		INCH	
	MIN	MAX	MIN	MAX		MIN	MAX	MIN	MAX
A	4.850	5.150	0,191	0.200	E2	3.600 REF.		0.142 REF.	
A1	2.200	2.600	0.087	0.102	L	40.900	41.300	1.610	1.626
B	1.000	1.400	0.039	0.055	L1	24.800	25.100	0.976	0.988
b1	2.800	3.200	0.110	0.126	L2	20.300	20.600	0.799	0.811
b2	1.800	2.200	0.071	0.087	Φ	7.100	7.300	0.280	0.287
c	0.500	0.700	0.020	0.028	e	5.450 TYP.		0.215 TYP.	
c1	1.900	2.100	0.075	0.083	H	5.980 REF.		0.235 REF.	
D	15.450	15.750	0.608	0.620	h	0.000	0.300	0.000	0.012
E1	3.500 REF.		0.138 REF.						

**ALL DIMENSIONS REFER TO JEDEC STANDARD
DO NOT INCLUDE MOLD FLASH OR PROTRUSIONS**

Customer Service

Worldwide Sales and Service:

Sales@ruichips.com

Technical Support:

Technical@ruichips.com

Investor Relations Contacts:

Investor@ruichips.com

Marcom Contact:

Marcom@ruichips.com

Editorial Contact:

Editorial@ruichips.com

HR Contact:

HR@ruichips.com

Legal Contact:

Legal@ruichips.com

Shen Zhen RUICHIPS Semiconductor CO., LTD

Room 501, the 5floor An Tong Industrial Building,
NO.207 Mei Hua Road Fu Tian Area Shen Zhen City, CHINA

TEL: (86-755) 8311-5334

FAX: (86-755) 8311-4278

E-mail: Sales-SZ@ruichips.com