

### Features

- 70V/200A,  
 $R_{DS(ON)} = 2.8m\Omega$  (Typ.) @  $V_{GS} = 10V$
- Ultra Low On-Resistance
- Exceptional dv/dt capability
- Fast Switching and Fully Avalanche Rated
- 100% avalanche tested
- 175°C Operating Temperature
- Lead Free and Green Available

### Applications

- Switching Application Systems
- Inverter Systems

### Pin Description

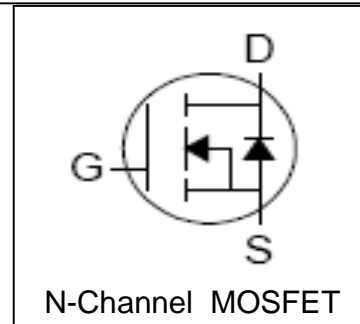
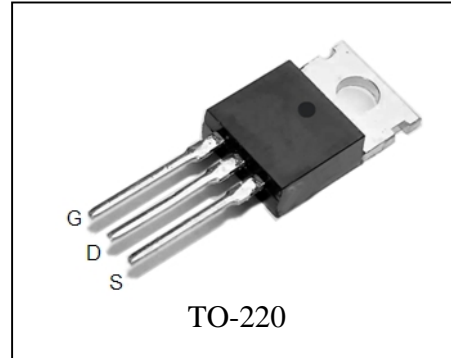

### Absolute Maximum Ratings

Symbol	Parameter	Rating	Unit
<b>Common Ratings</b> ( $T_A = 25^\circ C$ Unless Otherwise Noted)			
$V_{DSS}$	Drain-Source Voltage	70	V
$V_{GSS}$	Gate-Source Voltage	$\pm 25$	
$T_J$	Maximum Junction Temperature	175	$^\circ C$
$T_{STG}$	Storage Temperature Range	-55 to 175	$^\circ C$
$I_S$	Diode Continuous Forward Current	$T_C = 25^\circ C$ 200 <sup>①</sup>	A
<b>Mounted on Large Heat Sink</b>			
$I_{DP}$	300 $\mu s$ Pulse Drain Current Tested	$T_C = 25^\circ C$ 790 <sup>②</sup>	A
$I_D$	Continuous Drain Current ( $V_{GS} = 10V$ )	$T_C = 25^\circ C$ 200 <sup>①</sup>	A
		$T_C = 100^\circ C$ 145 <sup>①</sup>	
$P_D$	Maximum Power Dissipation	$T_C = 25^\circ C$ 333	W
		$T_C = 100^\circ C$ 167	
$R_{\theta JC}$	Thermal Resistance-Junction to Case	0.45	$^\circ C/W$
<b>Drain-Source Avalanche Ratings</b>			
$E_{AS}$ <sup>③</sup>	Avalanche Energy, Single Pulsed	1380	mJ

**Electrical Characteristics** ( $T_A=25^\circ\text{C}$  Unless Otherwise Noted)

Symbol	Parameter	Test Condition	RU70200R			Unit
			Min.	Typ.	Max.	
<b>Static Characteristics</b>						
$BV_{DSS}$	Drain-Source Breakdown Voltage	$V_{GS}=0V, I_{DS}=250\mu A$	70			V
$I_{DSS}$	Zero Gate Voltage Drain Current	$V_{DS}=70V, V_{GS}=0V$ $T_J=85^\circ\text{C}$			1 30	$\mu A$
$V_{GS(th)}$	Gate Threshold Voltage	$V_{DS}=V_{GS}, I_{DS}=250\mu A$	2	3	4	V
$I_{GSS}$	Gate Leakage Current	$V_{GS}=\pm 25V, V_{DS}=0V$			$\pm 100$	nA
$R_{DS(ON)}$ <sup>④</sup>	Drain-Source On-state Resistance	$V_{GS}=10V, I_{DS}=80A$		2.8	4	m $\Omega$
<b>Diode Characteristics</b>						
$V_{SD}$ <sup>④</sup>	Diode Forward Voltage	$I_{SD}=80A, V_{GS}=0V$			1.2	V
$t_{rr}$	Reverse Recovery Time	$I_{SD}=80A, di_{SD}/dt=100A/\mu s$		89		ns
$Q_{rr}$	Reverse Recovery Charge			175		nC
<b>Dynamic Characteristics</b> <sup>⑤</sup>						
$R_G$	Gate Resistance	$V_{GS}=0V, V_{DS}=0V, F=1\text{MHz}$		1.2		$\Omega$
$C_{iss}$	Input Capacitance	$V_{GS}=0V,$ $V_{DS}=30V,$ Frequency=1.0MHz		6500		pF
$C_{oss}$	Output Capacitance			940		
$C_{riss}$	Reverse Transfer Capacitance			650		
$t_{d(ON)}$	Turn-on Delay Time			29		
$t_r$	Turn-on Rise Time	$V_{DD}=30V, R_L=30\Omega,$ $I_{DS}=80A, V_{GEN}=10V,$ $R_G=6\Omega$		38		
$t_{d(OFF)}$	Turn-off Delay Time			80		
$t_f$	Turn-off Fall Time			125		
<b>Gate Charge Characteristics</b> <sup>⑤</sup>						
$Q_g$	Total Gate Charge	$V_{DS}=56V, V_{GS}=10V,$ $I_{DS}=80A$		158		nC
$Q_{gs}$	Gate-Source Charge			35		
$Q_{gd}$	Gate-Drain Charge			52		

- Notes: ① Calculated continuous current based on maximum allowable junction temperature. Package limitation current is 75A.  
 ② Pulse width limited by safe operating area.  
 ③ Limited by  $T_{Jmax}, I_{AS}=75A, V_{DD}=48V, R_G=47\Omega$ , Starting  $T_J=25^\circ\text{C}$ .  
 ④ Pulse test; Pulse width  $\leq 300\mu s$ , duty cycle  $\leq 2\%$ .  
 ⑤ Guaranteed by design, not subject to production testing.

**Typical Characteristics**

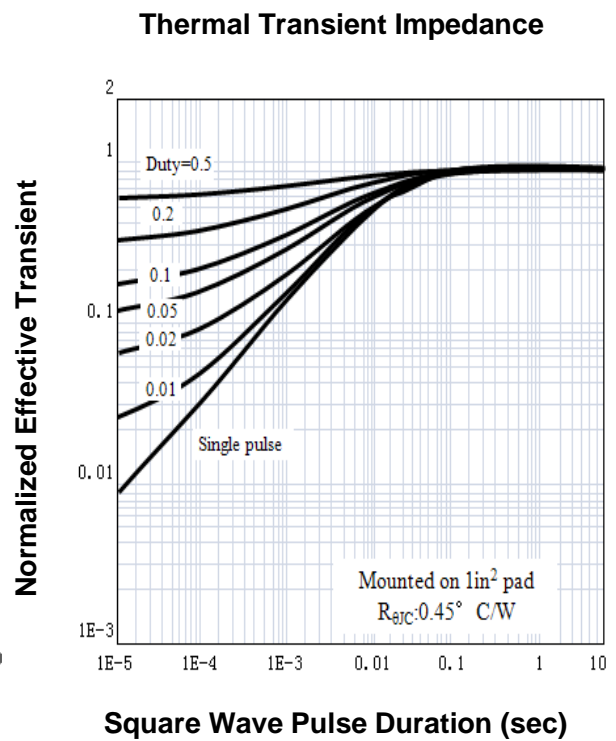
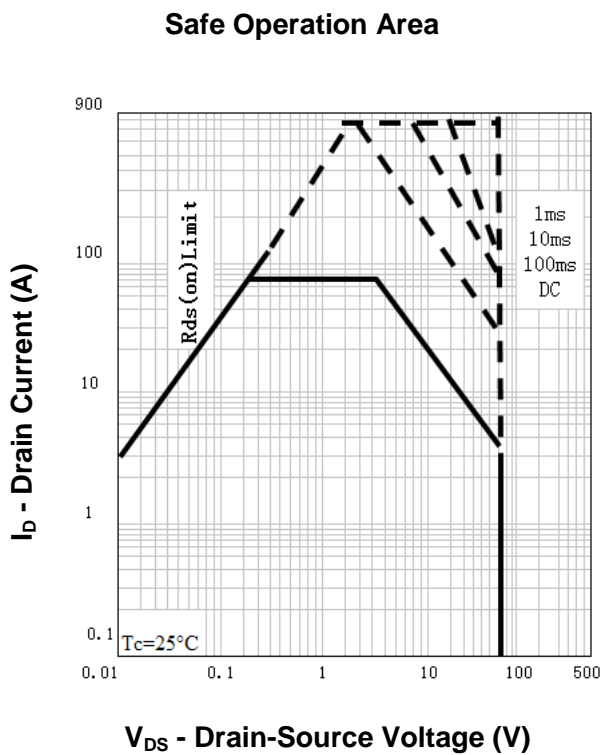
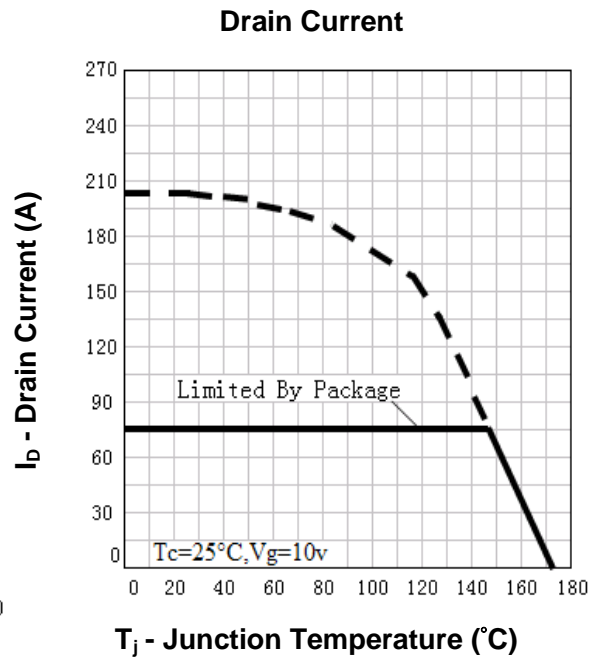
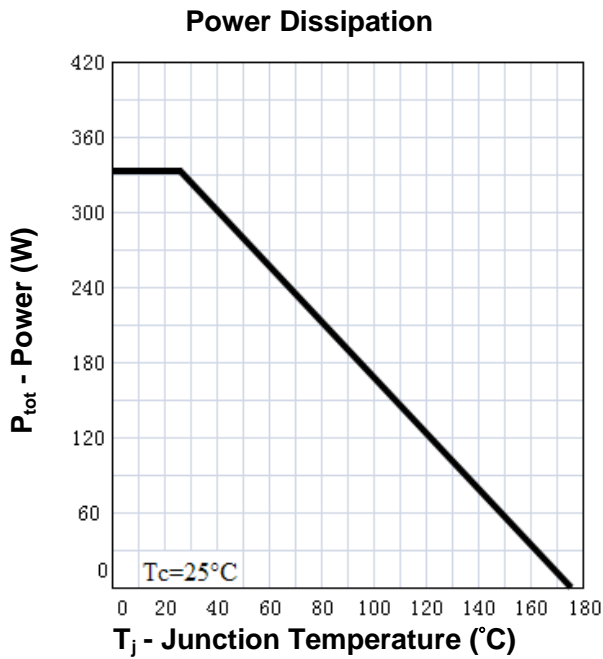

**Typical Characteristics**

**Output Characteristics**

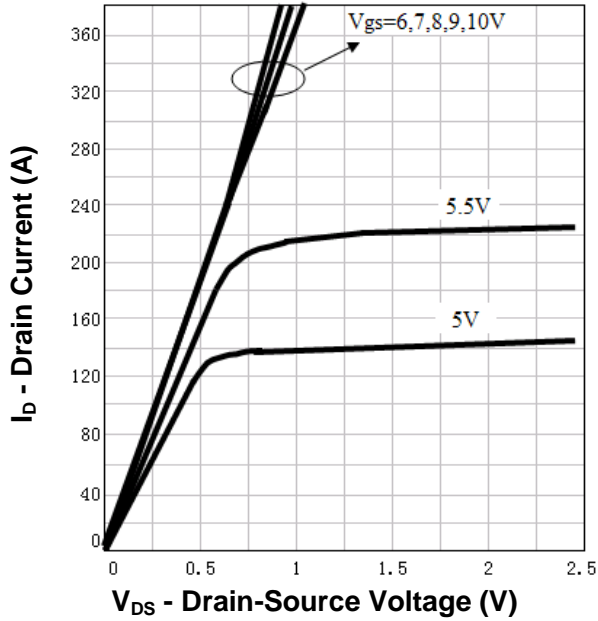

**Drain-Source On Resistance**

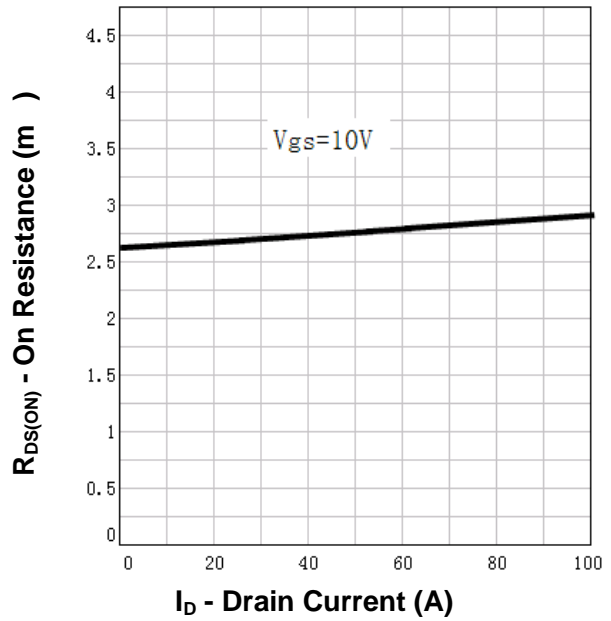

**Drain-Source On Resistance**

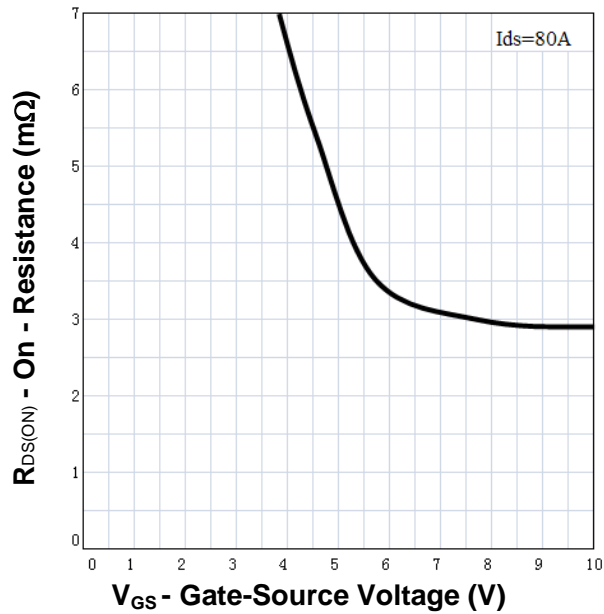

**Gate Threshold Voltage**

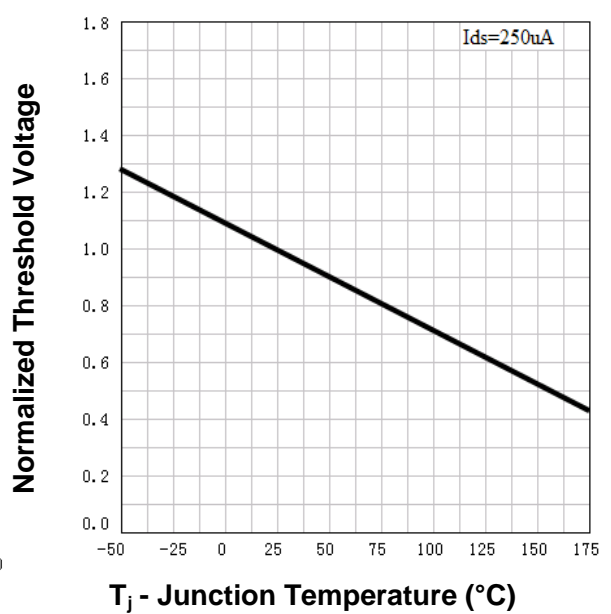

**Typical Characteristics**

**Drain-Source On Resistance**

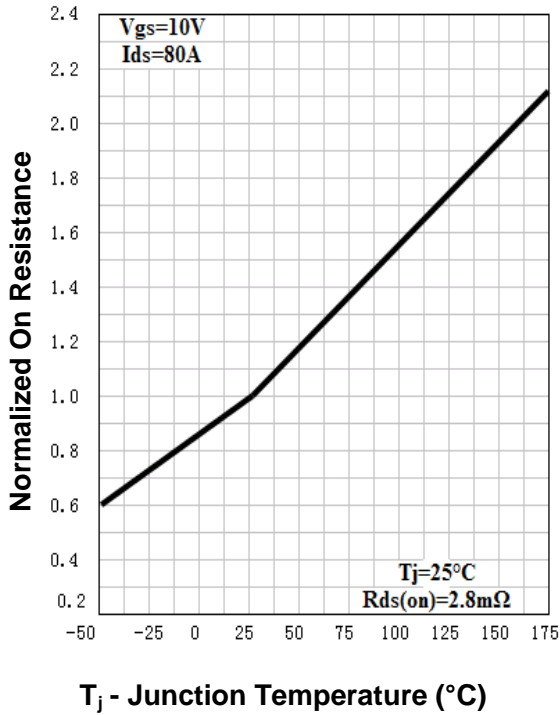

**Source-Drain Diode Forward**

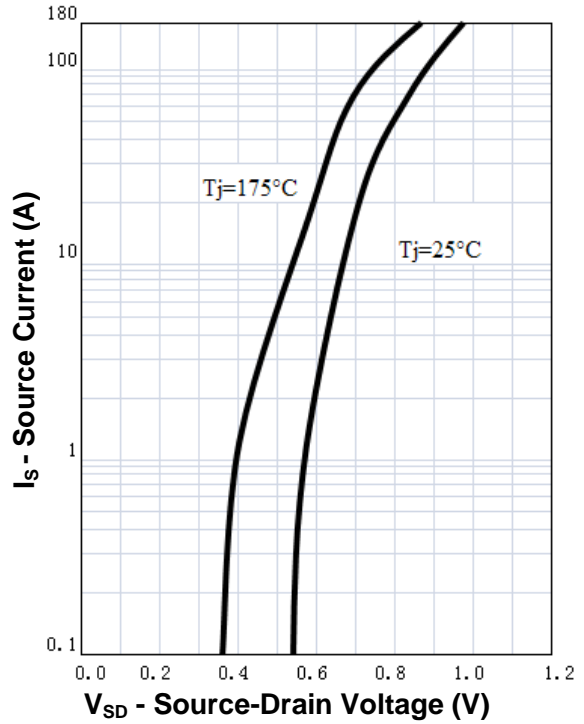

**Capacitance**

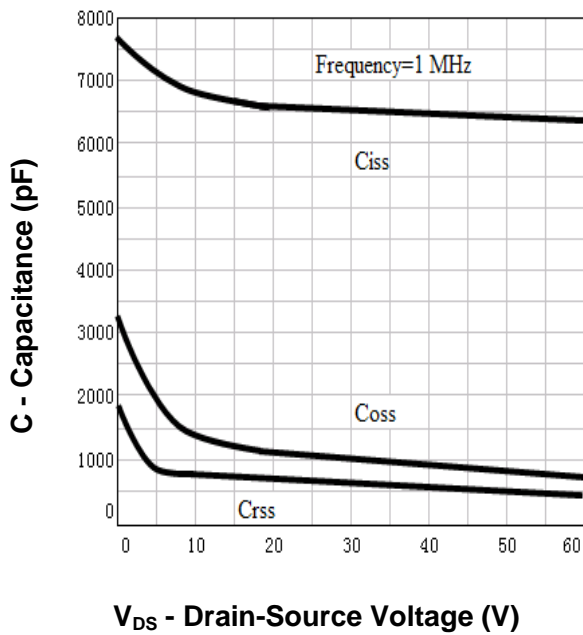

**Gate Charge**

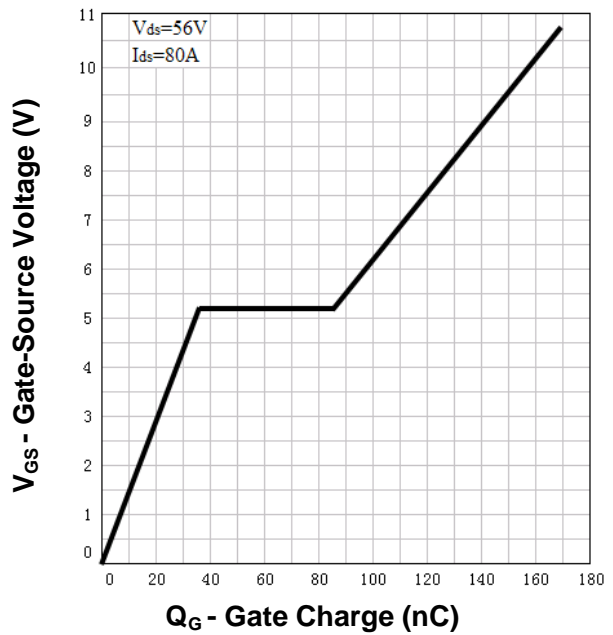

### Avalanche Test Circuit and Waveforms

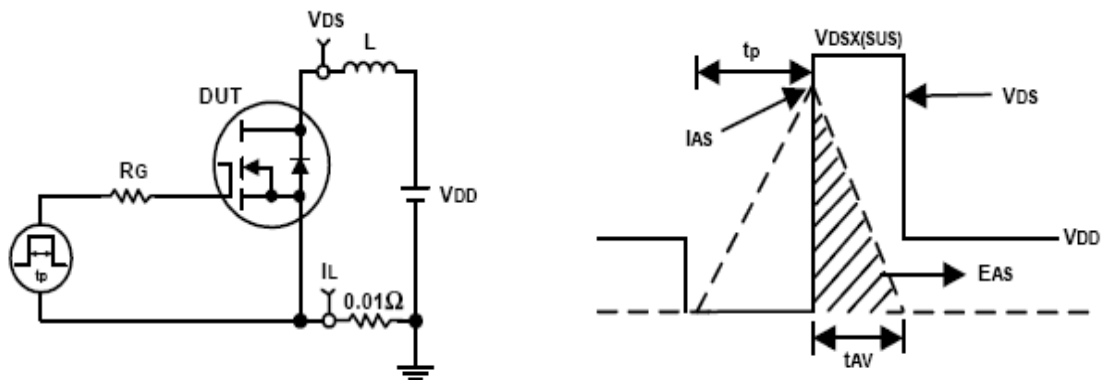

### Switching Time Test Circuit and Waveforms

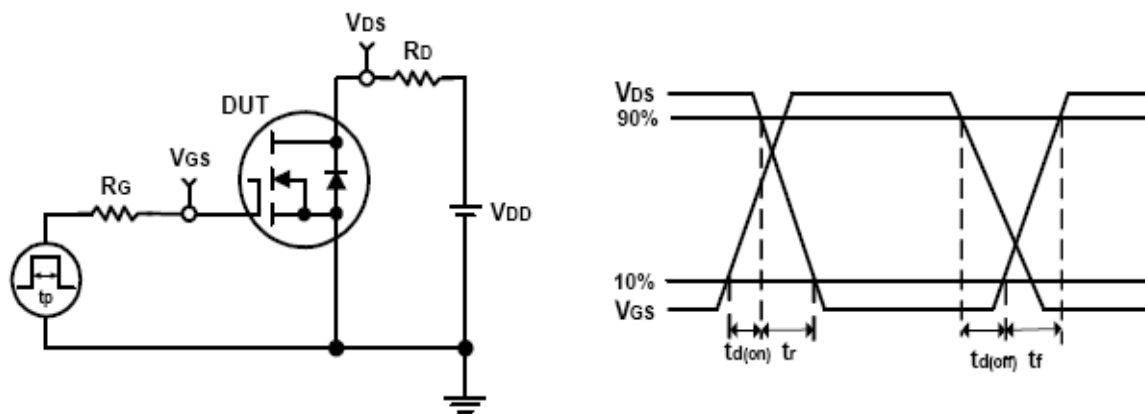

**Ordering and Marking Information**

<b>Device</b>	<b>Marking</b>	<b>Package</b>	<b>Packaging</b>	<b>Quantity</b>	<b>Reel Size</b>	<b>Tape width</b>
RU70200R	RU70200R	TO-220	Tube	50	-	-

**Package Information**

**TO-220FB-3L**



SYMBOL	MM			INCH			SYMBOL	MM			INCH		
	MIN	NOM	MAX	MIN	NOM	MAX		MIN	NOM	MAX	MIN	NOM	MAX
A	4.40	4.57	4.70	0.173	0.180	0.185	$\phi p1$	1.40	1.50	1.60	0.055	0.059	0.063
A1	1.27	1.30	1.33	0.050	0.051	0.052	e	2.54BSC			0.1BSC		
A2	2.35	2.40	2.50	0.093	0.094	0.098	e1	5.08BSC			0.2BSC		
b	0.77	-	0.90	0.030	-	0.035	H1	6.40	6.50	6.60	0.252	0.256	0.260
b2	1.23	-	1.36	0.048	-	0.054	L	12.75	-	13.17	0.502	-	0.519
C	0.48	0.50	0.52	0.019	0.020	0.021	L1	-	-	3.95	-	-	0.156
D	15.40	15.60	15.80	0.606	0.614	0.622	L2	2.50REF.			0.098REF.		
D1	9.00	9.10	9.20	0.354	0.358	0.362	$\phi p$	3.57	3.60	3.63	0.141	0.142	0.143
DEP	0.05	0.10	0.20	0.002	0.004	0.008	Q	2.73	2.80	2.87	0.107	0.110	0.113
E	9.70	9.90	10.10	0.382	0.389	0.398	$\theta 1$	5°	7°	9°	5°	7°	9°
E1	-	8.70	-	-	0.343	-	$\theta 2$	1°	3°	5°	1°	3°	5°
E2	9.80	10.00	10.20	0.386	0.394	0.401							

ALL DIMENSIONS REFER TO JEDEC STANDARD  
DO NOT INCLUDE MOLD FLASH OR PROTRUSIONS



## **Customer Service**

**Worldwide Sales and Service:**

Sales@ruichips.com

**Technical Support:**

Technical@ruichips.com

**Investor Relations Contacts:**

Investor@ruichips.com

**Marcom Contact:**

Marcom@ruichips.com

**Editorial Contact:**

Editorial@ruichips.com

**HR Contact:**

HR@ruichips.com

**Legal Contact:**

Legal@ruichips.com

**Shen Zhen RUICHIPS Semiconductor CO., LTD**

Room 501, the 5floor An Tong Industrial Building,  
NO.207 Mei Hua Road Fu Tian Area Shen Zhen City, CHINA

**TEL:** (86-755) 8311-5334

**FAX:** (86-755) 8311-4278

**E-mail:** Sales-SZ@ruichips.com