

# CGHV22200

## 200 W, 1800-2200 MHz, GaN HEMT for LTE

Cree's CGHV22200 is a gallium nitride (GaN) high electron mobility transistor (HEMT) is designed specifically for high efficiency, high gain and wide bandwidth capabilities, which makes the CGHV22200F ideal for 1.8 - 2.2 GHz LTE, 4G Telecom and BWA amplifier applications. The transistor is input matched and supplied in a ceramic/metal flange package.



Package Type: 440162 and 440161  
PN: CGHV22200F and CGHV22200P

### Typical Performance Over 1.8 - 2.2 GHz ( $T_c = 25^\circ\text{C}$ ) of Demonstration Amplifier

Parameter	1.8 GHz	2.0 GHz	2.2 GHz	Units
Gain @ 47 dBm	16.6	19.2	18.1	dB
ACLR @ 47 dBm	-37.4	-37.4	-35.6	dBc
Drain Efficiency @ 47 dBm	31.5	31.9	34.8	%

**Note:**

Measured in the CGHV22200-TB amplifier circuit, under WCDMA 3GPP test model 1, 64 DPCH, 45% clipping, PAR = 7.5 dB @ 0.01% Probability on CCDF.  $I_{DS} = 1.0\text{ A}$

### Features

- 1.8 - 2.2 GHz Operation
- 18 dB Gain
- -35 dBc ACLR at 50 W  $P_{AVE}$
- 31-35 % Efficiency at 50 W  $P_{AVE}$
- High Degree of DPD Correction Can be Applied





## Absolute Maximum Ratings (not simultaneous) at 25 °C Case Temperature

Parameter	Symbol	Rating	Units	Units
Drain-Source Voltage	$V_{DSS}$	125	Volts	25 °C
Gate-to-Source Voltage	$V_{GS}$	-10, +2	Volts	25 °C
Storage Temperature	$T_{STG}$	-65, +150	°C	
Operating Junction Temperature <sup>3</sup>	$T_J$	225	°C	
Maximum Forward Gate Current	$I_{GMAX}$	32	mA	25 °C
Maximum Drain Current <sup>1</sup>	$I_{DMAX}$	12	A	25 °C
Soldering Temperature <sup>2</sup>	$T_S$	245	°C	
Screw Torque	$\tau$	80	in-oz	
Thermal Resistance, Junction to Case <sup>3</sup>	$R_{\theta JC}$	1.22	°C/W	85 °C, $P_{DISS} = 96$ W
Thermal Resistance, Junction to Case <sup>4</sup>	$R_{\theta JC}$	1.54	°C/W	85 °C, $P_{DISS} = 96$ W
Case Operating Temperature <sup>5</sup>	$T_C$	-40, +150	°C	

Note:

<sup>1</sup> Current limit for long term, reliable operation.

<sup>2</sup> Refer to the Application Note on soldering at <http://www.cree.com/rf/document-library>

<sup>3</sup> Measured for the CGHV22200P

<sup>4</sup> Measured for the CGHV22200F

<sup>5</sup> See also, the Power Dissipation De-rating Curve on Page 6.

## Electrical Characteristics ( $T_C = 25$ °C)

Characteristics	Symbol	Min.	Typ.	Max.	Units	Conditions
<b>DC Characteristics<sup>1</sup></b>						
Gate Threshold Voltage	$V_{GS(th)}$	-3.8	-3.0	-2.3	$V_{DC}$	$V_{DS} = 10$ V, $I_D = 32$ mA
Gate Quiescent Voltage	$V_{GS(Q)}$	-	-2.7	-	$V_{DC}$	$V_{DS} = 50$ V, $I_D = 1.0$ A
Saturated Drain Current <sup>2</sup>	$I_{DS}$	24	28.8	-	A	$V_{DS} = 6.0$ V, $V_{GS} = 2.0$ V
Drain-Source Breakdown Voltage	$V_{BR}$	150	-	-	$V_{DC}$	$V_{GS} = -8$ V, $I_D = 32$ mA
<b>RF Characteristics<sup>3</sup> (<math>T_C = 25</math> °C, <math>F_0 = 2.17</math> GHz unless otherwise noted)</b>						
Saturated Output Power <sup>3,4</sup>	$P_{SAT}$	-	240	-	W	$V_{DD} = 50$ V, $I_{DQ} = 1.0$ A
Pulsed Drain Efficiency <sup>3</sup>	$\eta$	-	65	-	%	$V_{DD} = 50$ V, $I_{DQ} = 1.0$ A, $P_{OUT} = P_{SAT}$
Gain <sup>6</sup>	G	-	18.0	-	dB	$V_{DD} = 50$ V, $I_{DQ} = 1.0$ A, $P_{OUT} = 47$ dBm
WCDMA Linearity <sup>6</sup>	ACLR	-	-36.7	-	dBc	$V_{DD} = 50$ V, $I_{DQ} = 1.0$ A, $P_{OUT} = 47$ dBm
Drain Efficiency <sup>6</sup>	$\eta$	-	34.5	-	%	$V_{DD} = 50$ V, $I_{DQ} = 1.0$ A, $P_{OUT} = 47$ dBm
Output Mismatch Stress <sup>3</sup>	VSWR	-	-	10 : 1	$\Psi$	No damage at all phase angles, $V_{DD} = 50$ V, $I_{DQ} = 1.0$ A, $P_{OUT} = 200$ W Pulsed
<b>Dynamic Characteristics</b>						
Input Capacitance <sup>7</sup>	$C_{GS}$	-	97	-	pF	$V_{DS} = 50$ V, $V_{gs} = -8$ V, $f = 1$ MHz
Output Capacitance <sup>7</sup>	$C_{DS}$	-	13.4	-	pF	$V_{DS} = 50$ V, $V_{gs} = -8$ V, $f = 1$ MHz
Feedback Capacitance	$C_{GD}$	-	0.94	-	pF	$V_{DS} = 50$ V, $V_{gs} = -8$ V, $f = 1$ MHz

Notes:

<sup>1</sup> Measured on wafer prior to packaging.

<sup>2</sup> Scaled from PCM data.

<sup>3</sup> Pulse Width = 100  $\mu$ S, Duty Cycle = 10%

<sup>4</sup>  $P_{SAT}$  is defined as  $I_G = 3$  mA peak.

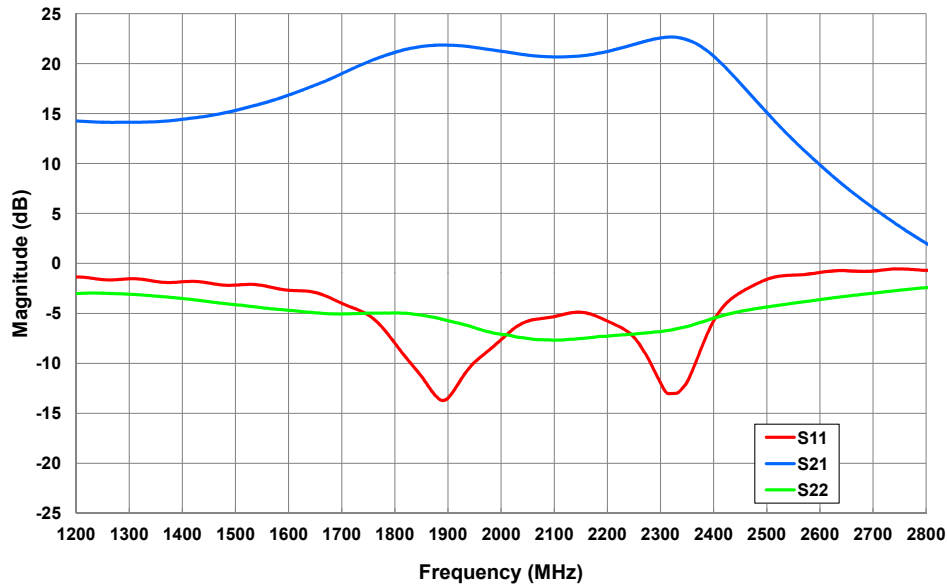
<sup>5</sup> Measured in CGHV22200-TB.

<sup>6</sup> Single Carrier WCDMA, 3GPP Test Model 1, 64 DPCH, 45% Clipping, PAR = 7.5 dB @ 0.01% Probability on CCDF.

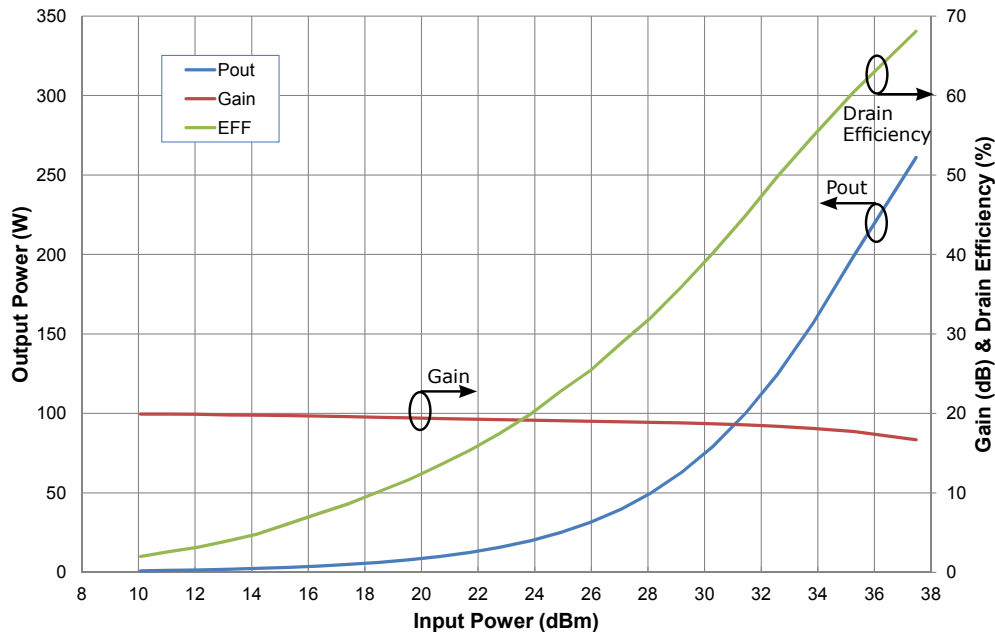
<sup>7</sup> Includes package and internal matching components.

## Typical Performance

**Figure 1. - Small Signal Gain and Return Losses vs Frequency for the CGHV22200 measured in CGHV22200-TB Amplifier Circuit**  
 $V_{DD} = 50 \text{ V}$ ,  $I_{DQ} = 1.0 \text{ A}$

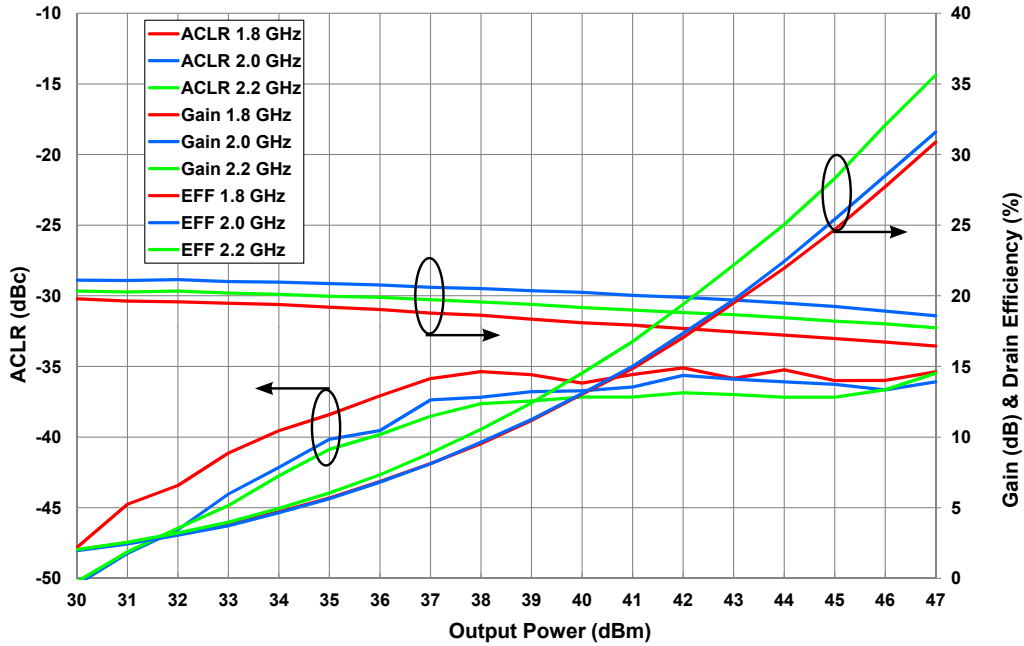


**Figure 2. - Typical Gain and Drain Efficiency vs Input Power of the CGHV22200 measured in CGHV22200-TB Amplifier Circuit.**  
 $V_{DS} = 50 \text{ V}$ ,  $I_{DQ} = 1.0 \text{ A}$ , Freq = 2.1 GHz, Pulse Width = 100  $\mu\text{s}$ , Duty Cycle = 10 %

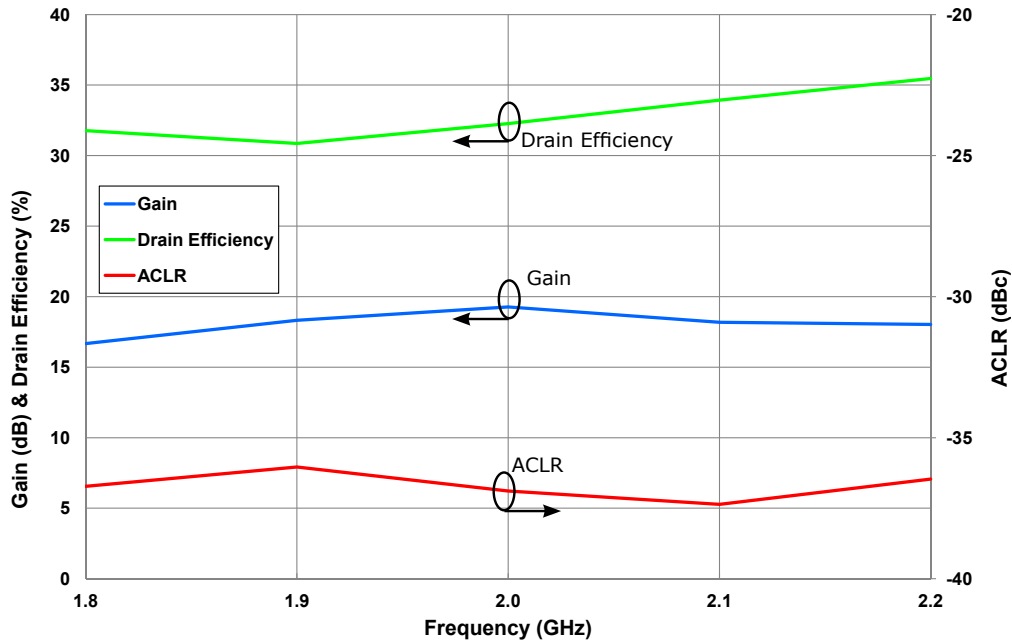


## Typical Performance

**Figure 3. - Typical WCDMA Transfer Characteristics**  
 $V_{DD} = 50\text{ V}$ ,  $I_{DS} = 1.0\text{ A}$ , 1c WCDMA, PAR = 7.5 dB

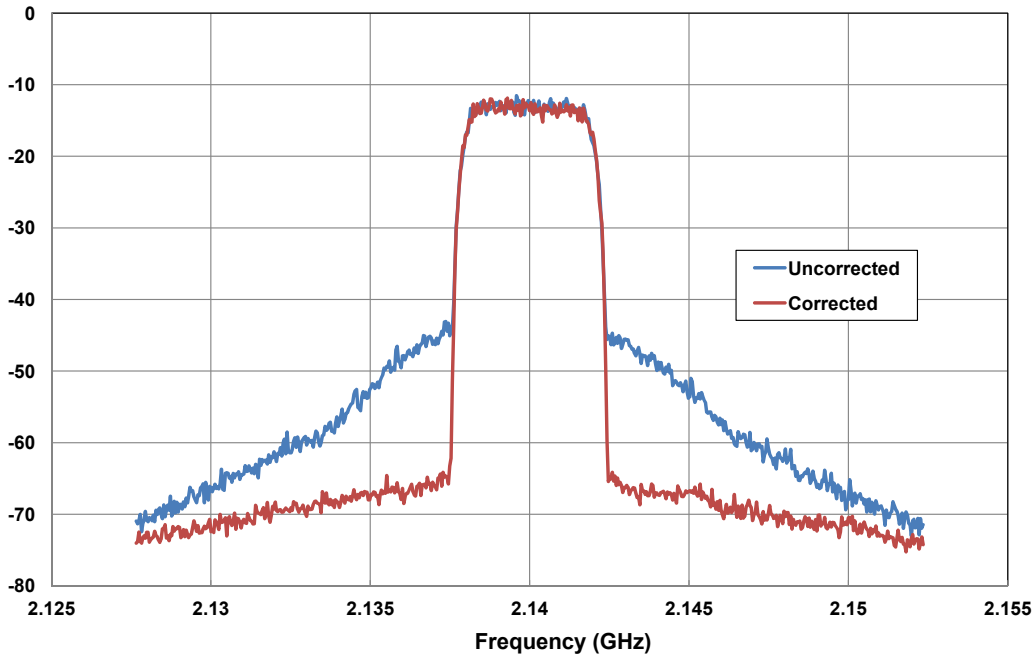


**Figure 4. - Typical Gain, Drain Efficiency and ACLR vs Frequency**  
of the CGHV22200 measured in CGHV22200-TB Amplifier Circuit  
 $V_{DD} = 50\text{ V}$ ,  $I_{DS} = 1.0\text{ A}$ ,  $P_{AVE} = 50\text{ W}$ , 1c WCDMA, PAR = 7.5 dB

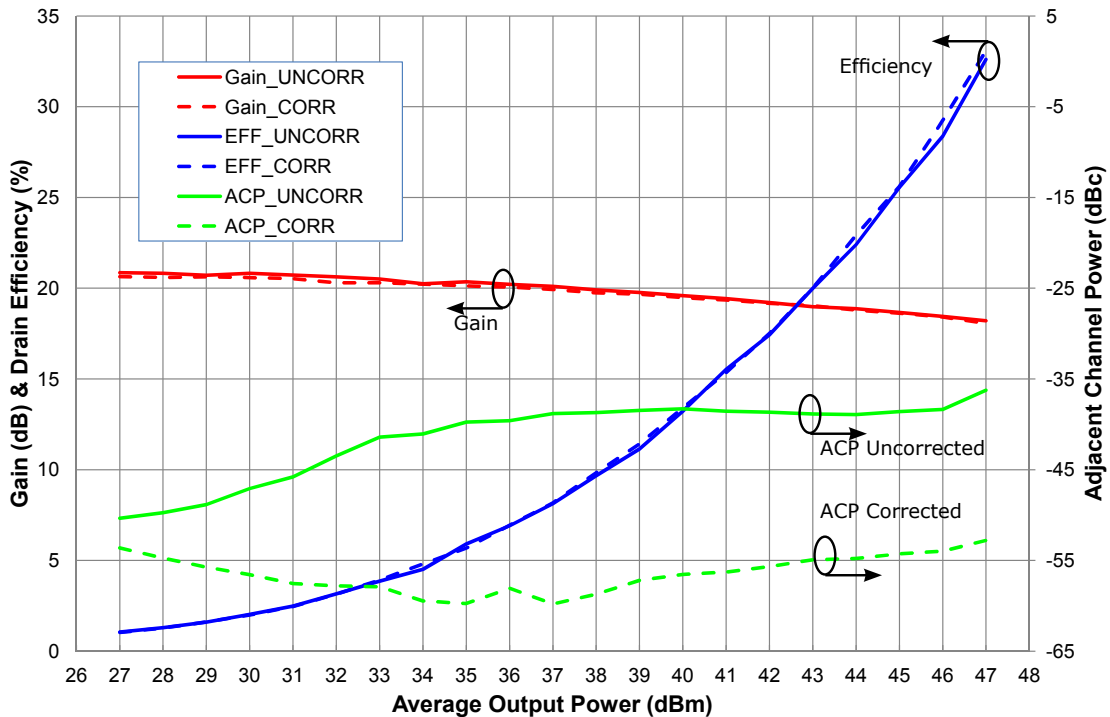


## Typical Performance

**Figure 5. - CGHV22200 Spectral Mask at  $P_{AVE} = 47$  dBm with and without DPD**  
 $V_{DD} = 50$ ,  $I_{DQ} = 1.0$  A, Freq = 2.14 GHz, 1 C WCDMA 7.5 PAR

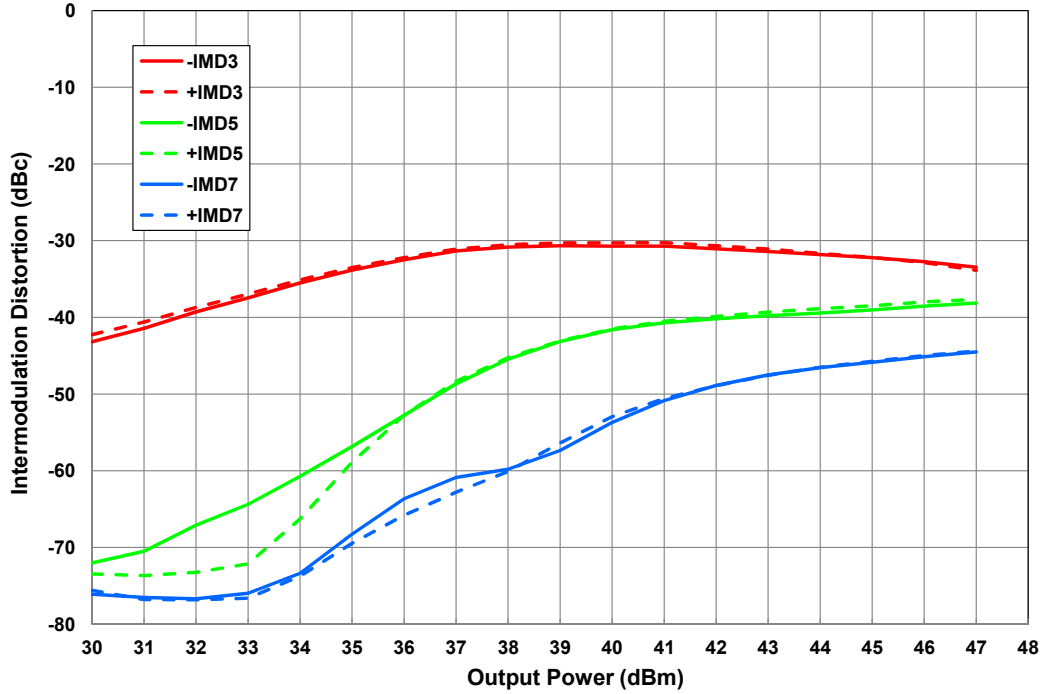


**Figure 6. - CGHV22200 Typical Linearity under DPD vs. Output Power**  
 $V_{DD} = 50$ ,  $I_{DQ} = 1.0$  A, Freq = 2.14 GHz, 1 C WCDMA 7.5 PAR

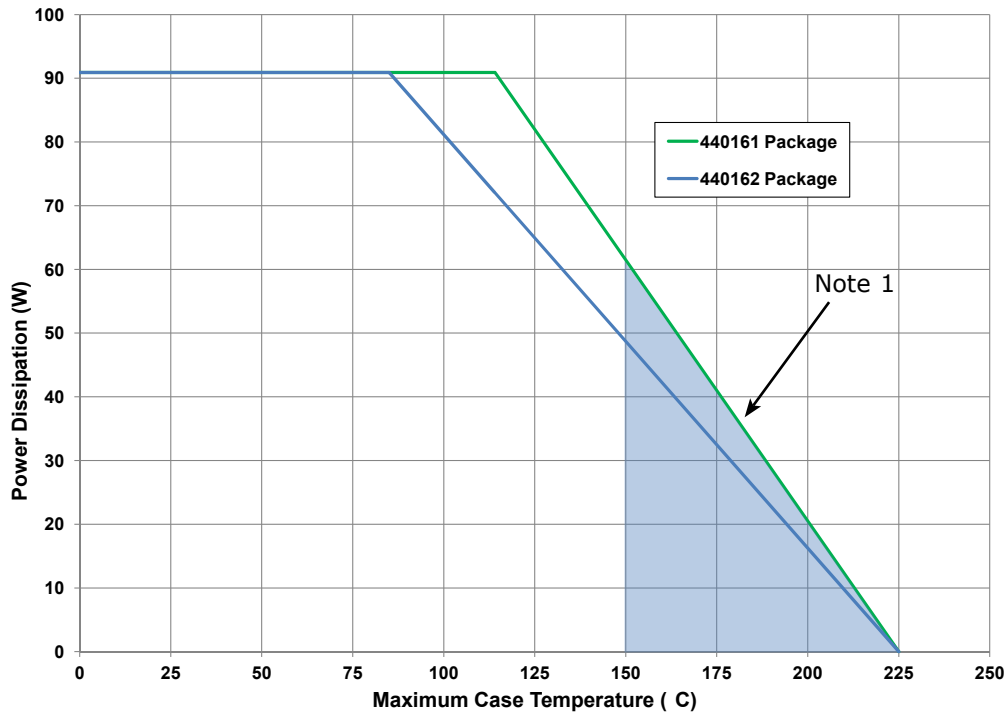


## Typical Performance

**Figure 7. - Intermodulation Distortion Products vs Output Power**  
 Freq. = 2.1 GHz, VDD = 50 V, IDQ = 1.0 A, Tone Spacing = 100 kHz.

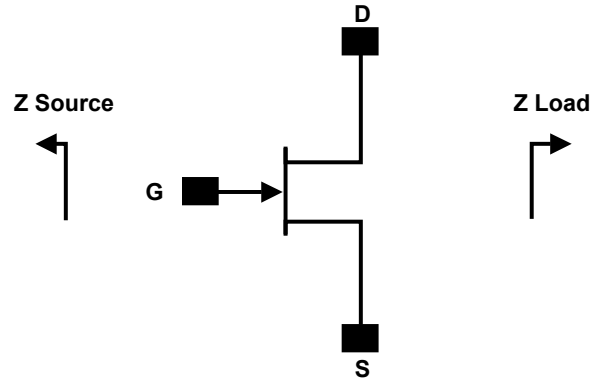


**Figure 8. - Power Dissipation Derating Curve**



Note 1. Area exceeds Maximum Case Operating Temperature (See Page 2).

## Source and Load Impedances



Frequency (MHz)	Z Source	Z Load
1800	10.6 - j7.3	2.7 + j0.6
1900	8.1 - j7.4	2.8 + j0.7
2000	6.1 - j6.6	2.9 + j0.8
2100	4.7 - j5.5	2.8 + j0.8
2200	3.7 - j4.3	2.6 + j0.8

Note<sup>1</sup>:  $V_{DD} = 50\text{ V}$ ,  $I_{DQ} = 1.0\text{ A}$ . In the 440162 package.

Note<sup>2</sup>: Impedances are extracted from CGHV22200-TB demonstration circuit and are not source and load pull data derived from transistor.

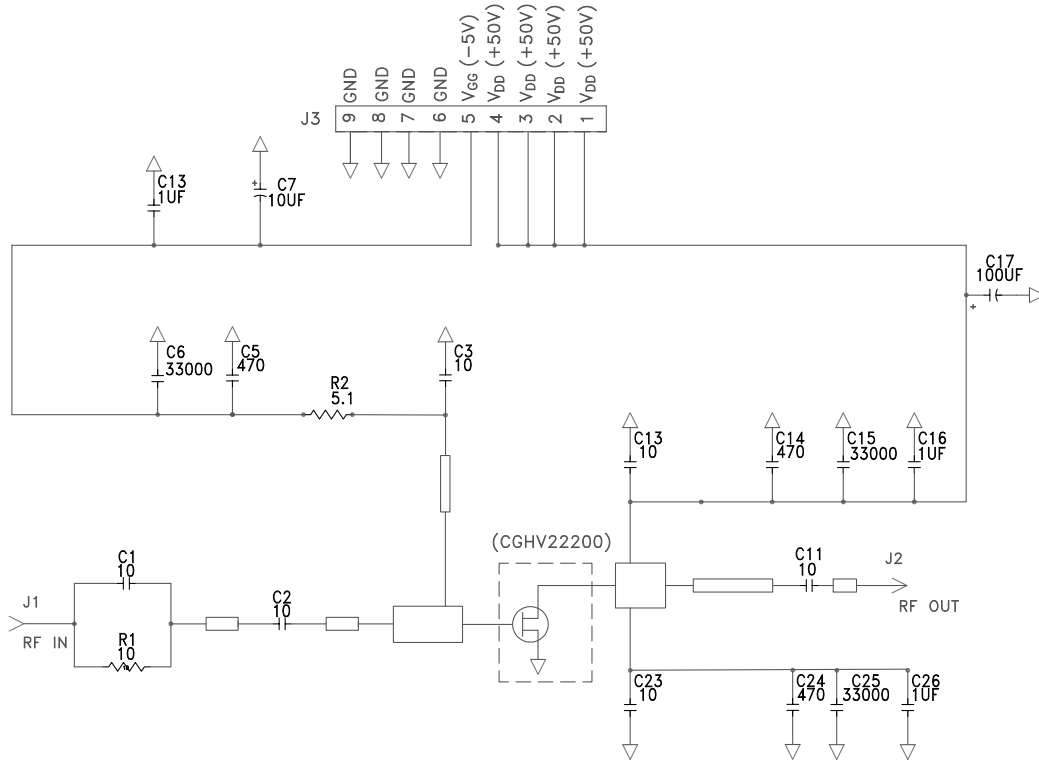


## CGHV22200-TB Demonstration Amplifier Circuit Bill of Materials

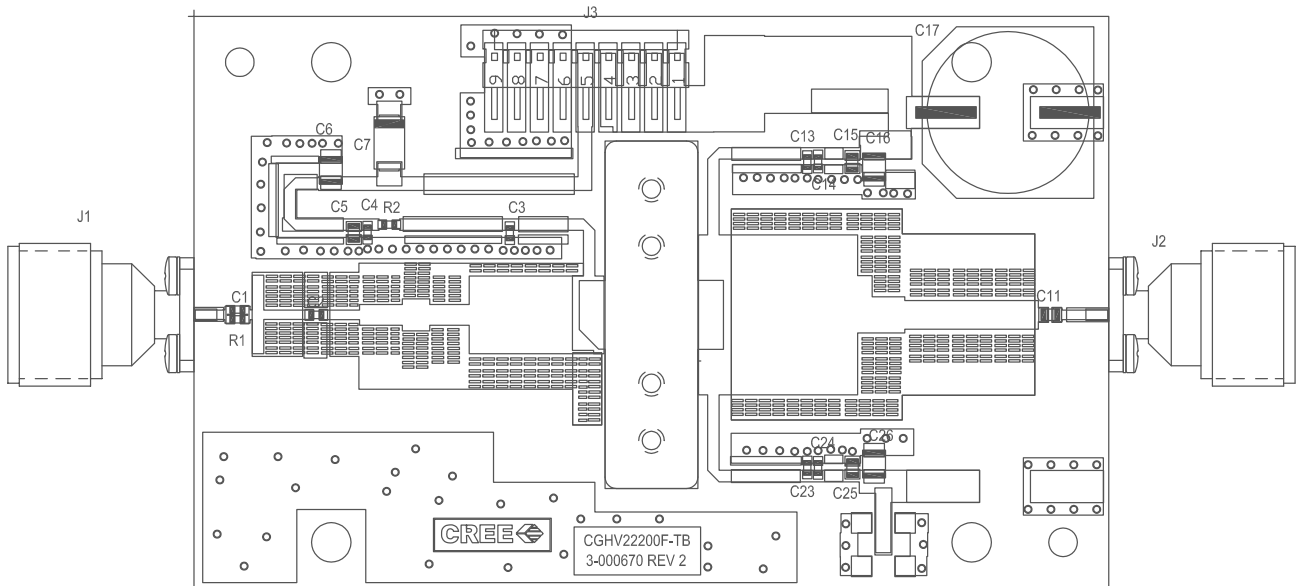
Designator	Description	Qty
R1	RES, 1/16 W, 0603, 1%, 10.0 OHMS	1
R2	RES, 1/16 W, 0603, 1%, 5.1 OHMS	1
C4, C14, C24	CAP, 470 pF, 5%, 100 V, 0603, X	3
C6, C16, C26	CAP, 1.0 uF, 100 V, 10%, x7R, 121	3
C17, C27	CAP, 100 uF, 20%, 160 V, ELEC	2
C7	CAP, 10 uF, 16 V, TANTALUM, 2312	1
C1, C2, C3, C13, C23	CAP, 10.0 pF, 5%, 0603, ATC	5
C5, C15, C25	CAP, 33000 pF, 0805, 100 V, X7R	3
C11	CAP, 10 pF, 5%, 250 V, 0805, A	1
J1, J2	CONN, N, FEM, W/.500 SMA FLNG	2
J3	HEADER RT>PLZ .1CEN LK 9POS	1
	PCB, CGHV22200F, RO4350, 0.020" THK	1
	2-56 SOC HD SCREW 1/4 SS	4
	#2 SPLIT LOCKWASHER SS	4
	CGHV22200	1



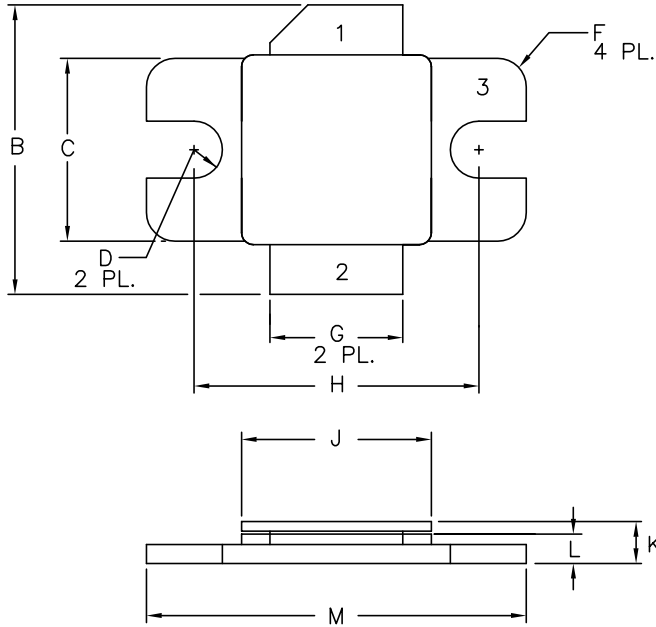
## CGHV22200-TB Demonstration Amplifier Circuit Schematic



## CGHV22200-TB Demonstration Amplifier Circuit Outline



## Product Dimensions CGHV22200F (Package Type — 440162)



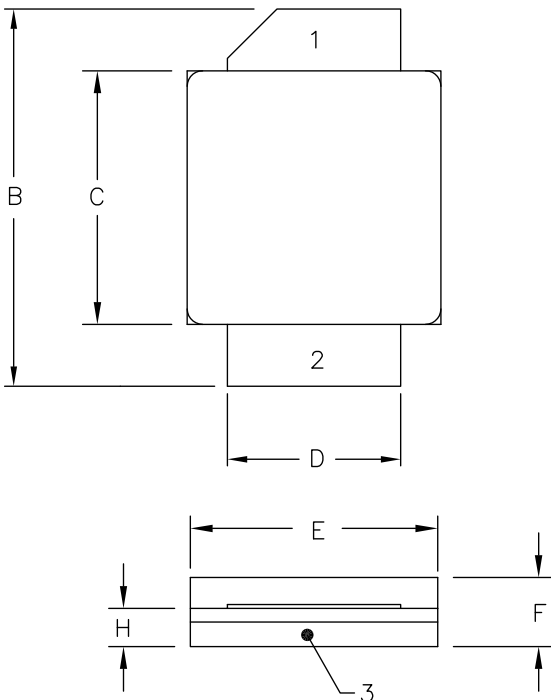
**NOTES:**

1. DIMENSIONING AND TOLERANCING PER ANSI Y14.5M, 1982.
2. CONTROLLING DIMENSION: INCH.
3. ADHESIVE FROM LID MAY EXTEND A MAXIMUM OF 0.020" BEYOND EDGE OF LID.
4. LID MAY BE MISALIGNED TO THE BODY OF THE PACKAGE BY A MAXIMUM OF 0.008" IN ANY DIRECTION.

DIM	INCHES		MILLIMETERS	
	MIN	MAX	MIN	MAX
A	.395	.405	10.03	10.29
B	.580	.620	14.73	15.75
C	.380	.390	9.65	9.91
D	.055	.065	1.40	1.65
E	.004	.006	0.10	0.15
F	.055	.065	1.40	1.65
G	.275	.285	6.99	7.24
H	.595	.605	15.11	15.37
J	.395	.405	10.03	10.29
K	.129	.149	3.28	3.78
L	.053	.067	1.35	1.70
M	.795	.805	20.19	20.45

PIN 1. GATE  
 PIN 2. DRAIN  
 PIN 3. SOURCE

## Product Dimensions CGHV22200P (Package Type — 440161)



**NOTES:**

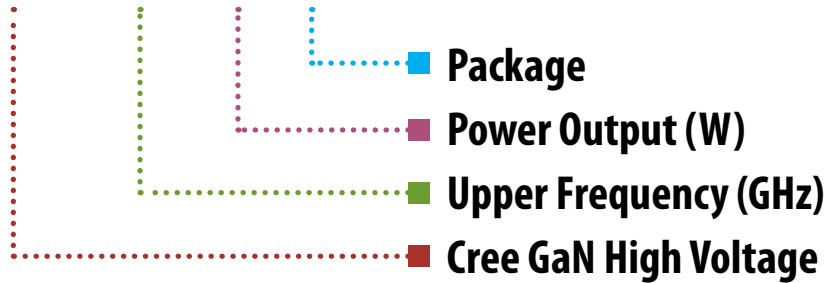
1. DIMENSIONING AND TOLERANCING PER ANSI Y14.5M, 1982.
2. CONTROLLING DIMENSION: INCH.
3. ADHESIVE FROM LID MAY EXTEND A MAXIMUM OF 0.020" BEYOND EDGE OF LID.
4. LID MAY BE MISALIGNED TO THE BODY OF PACKAGE BY A MAXIMUM OF 0.008" IN ANY DIRECTION.

DIM	INCHES		MILLIMETERS	
	MIN	MAX	MIN	MAX
A	.395	.407	10.03	10.34
B	.594	.634	15.09	16.10
C	.395	.407	10.03	10.34
D	.275	.285	6.99	7.24
E	.395	.407	10.03	10.34
F	.129	.149	3.28	3.78
G	.004	.006	0.10	0.15
H	.057	.067	1.45	1.70

PIN 1. GATE  
 PIN 2. DRAIN  
 PIN 3. SOURCE

## Part Number System

# CGHV22200F



Parameter	Value	Units
Upper Frequency <sup>1</sup>	2.2	GHz
Power Output	200	W
Package	Flange	-

**Table 1.**

**Note<sup>1</sup>:** Alpha characters used in frequency code indicate a value greater than 9.9 GHz. See Table 2 for value.

Character Code	Code Value
A	0
B	1
C	2
D	3
E	4
F	5
G	6
H	7
J	8
K	9
Examples:	1A = 10.0 GHz 2H = 27.0 GHz

**Table 2.**



## Disclaimer

Specifications are subject to change without notice. Cree, Inc. believes the information contained within this data sheet to be accurate and reliable. However, no responsibility is assumed by Cree for any infringement of patents or other rights of third parties which may result from its use. No license is granted by implication or otherwise under any patent or patent rights of Cree. Cree makes no warranty, representation or guarantee regarding the suitability of its products for any particular purpose. "Typical" parameters are the average values expected by Cree in large quantities and are provided for information purposes only. These values can and do vary in different applications and actual performance can vary over time. All operating parameters should be validated by customer's technical experts for each application. Cree products are not designed, intended or authorized for use as components in applications intended for surgical implant into the body or to support or sustain life, in applications in which the failure of the Cree product could result in personal injury or death or in applications for planning, construction, maintenance or direct operation of a nuclear facility.

For more information, please contact:

Cree, Inc.  
4600 Silicon Drive  
Durham, North Carolina, USA 27703  
[www.cree.com/rf](http://www.cree.com/rf)

Sarah Miller  
Marketing & Export  
Cree, RF Components  
1.919.407.5302

Ryan Baker  
Marketing  
Cree, RF Components  
1.919.407.7816

Tom Dekker  
Sales Director  
Cree, RF Components  
1.919.407.5639