

HEXFET® Power MOSFET

$V_{DS}$	30	V
$R_{DS(on) \max} Q1$ (@ $V_{GS} = 10V$ )	16.4	m $\Omega$
$R_{DS(on) \max} Q2$ (@ $V_{GS} = 10V$ )	11.8	
$Q_g$ (typical) Q1	6.7	nC
$Q_g$ (typical) Q2	14	
$I_D$ (@ $T_A = 25^\circ C$ ) Q1	9.1	A
$I_D$ (@ $T_A = 25^\circ C$ ) Q2	11	

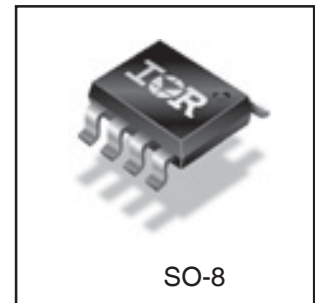
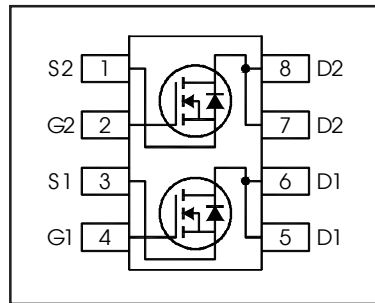

**Applications**

- Dual SO-8 MOSFET for POL Converters in Notebook Computers, Servers, Graphics Cards, Game Consoles and Set-Top Box

**Features**

Industry-standard pinout SO-8 Package
Compatible with Existing Surface Mount Techniques
RoHS Compliant, Halogen-Free
MSL1, Industrial qualification



**Benefits**

Multi-Vendor Compatibility
Easier Manufacturing
Environmentally Friendlier
Increased Reliability

Base Part Number	Package Type	Standard Pack		Orderable Part Number
		Form	Quantity	
IRF7907PbF-1	SO-8	Tape and Reel	4000	IRF7907TRPbF-1

**Absolute Maximum Ratings**

	Parameter	Q1 Max.	Q2 Max.	Units
$V_{DS}$	Drain-to-Source Voltage	30		V
$V_{GS}$	Gate-to-Source Voltage	± 20		
$I_D @ T_A = 25^\circ C$	Continuous Drain Current, $V_{GS} @ 10V$	9.1	11	A
$I_D @ T_A = 70^\circ C$	Continuous Drain Current, $V_{GS} @ 10V$	7.3	8.8	
$I_{DM}$	Pulsed Drain Current ①	76	85	
$P_D @ T_A = 25^\circ C$	Power Dissipation	2.0	2.0	W
$P_D @ T_A = 70^\circ C$	Power Dissipation	1.3	1.3	
	Linear Derating Factor	0.016	0.016	W/°C
$T_J$ $T_{STG}$	Operating Junction and Storage Temperature Range	-55 to + 150		°C

**Thermal Resistance**

	Parameter	Q1 Max.	Q2 Max.	Units
$R_{\theta JL}$	Junction-to-Drain Lead ⑤	42	42	°C/W
$R_{\theta JA}$	Junction-to-Ambient ④⑤	62.5	62.5	

Notes ① through ⑤ are on page 11.

**Static @ T<sub>J</sub> = 25°C (unless otherwise specified)**

	Parameter		Min.	Typ.	Max.	Units	Conditions		
BV <sub>DSS</sub>	Drain-to-Source Breakdown Voltage	Q1&Q2	30	—	—	V	V <sub>GS</sub> = 0V, I <sub>D</sub> = 250μA		
ΔBV <sub>DSS</sub> /ΔT <sub>J</sub>	Breakdown Voltage Temp. Coefficient	Q1	—	0.024	—	V/°C	Reference to 25°C, I <sub>D</sub> = 1mA		
		Q2	—	0.024	—				
R <sub>DS(on)</sub>	Static Drain-to-Source On-Resistance	Q1	—	13.7	16.4	mΩ	V <sub>GS</sub> = 10V, I <sub>D</sub> = 9.1A ③		
			—	17.1	20.5		V <sub>GS</sub> = 4.5V, I <sub>D</sub> = 7.3A ③		
		Q2	—	9.8	11.8		V <sub>GS</sub> = 10V, I <sub>D</sub> = 11A ③		
			—	11.5	13.7		V <sub>GS</sub> = 4.5V, I <sub>D</sub> = 8.8A ③		
V <sub>GS(th)</sub>	Gate Threshold Voltage	Q1&Q2	1.35	1.8	2.35	V	Q1: V <sub>DS</sub> = V <sub>GS</sub> , I <sub>D</sub> = 25μA		
ΔV <sub>GS(th)</sub> /ΔT <sub>J</sub>	Gate Threshold Voltage Coefficient	Q1	—	-4.6	—	mV/°C	Q2: V <sub>DS</sub> = V <sub>GS</sub> , I <sub>D</sub> = 50μA		
		Q2	—	-4.9	—				
I <sub>DSS</sub>	Drain-to-Source Leakage Current	Q1&Q2	—	—	1.0	μA	V <sub>DS</sub> = 24V, V <sub>GS</sub> = 0V		
		Q1&Q2	—	—	150		V <sub>DS</sub> = 24V, V <sub>GS</sub> = 0V, T <sub>J</sub> = 125°C		
I <sub>GSS</sub>	Gate-to-Source Forward Leakage	Q1&Q2	—	—	100	nA	V <sub>GS</sub> = 20V		
	Gate-to-Source Reverse Leakage	Q1&Q2	—	—	-100		V <sub>GS</sub> = -20V		
g <sub>fs</sub>	Forward Transconductance	Q1	19	—	—	S	V <sub>DS</sub> = 15V, I <sub>D</sub> = 7.0A		
		Q2	24	—	—		V <sub>DS</sub> = 15V, I <sub>D</sub> = 8.8A		
Q <sub>g</sub>	Total Gate Charge	Q1	—	6.7	10	nC	Q1 V <sub>DS</sub> = 15V V <sub>GS</sub> = 4.5V, I <sub>D</sub> = 7.0A  Q2 V <sub>DS</sub> = 15V V <sub>GS</sub> = 4.5V, I <sub>D</sub> = 8.8A		
		Q2	—	14	21				
Q <sub>gs1</sub>	Pre-V <sub>th</sub> Gate-to-Source Charge	Q1	—	1.3	—				
		Q2	—	3.0	—				
Q <sub>gs2</sub>	Post-V <sub>th</sub> Gate-to-Source Charge	Q1	—	0.7	—				
		Q2	—	1.3	—				
Q <sub>gd</sub>	Gate-to-Drain Charge	Q1	—	2.5	—				
		Q2	—	4.9	—				
Q <sub>godr</sub>	Gate Charge Overdrive	Q1	—	2.2	—				
		Q2	—	4.8	—				
Q <sub>sw</sub>	Switch Charge (Q <sub>gs2</sub> + Q <sub>gd</sub> )	Q1	—	3.2	—				
		Q2	—	6.2	—				
Q <sub>oss</sub>	Output Charge	Q1	—	4.5	—			nC	V <sub>DS</sub> = 16V, V <sub>GS</sub> = 0V
		Q2	—	9.0	—				
R <sub>G</sub>	Gate Resistance	Q1	—	2.6	4.7	Ω			
		Q2	—	3.0	5.0				
t <sub>d(on)</sub>	Turn-On Delay Time	Q1	—	6.0	—	ns	Q1 V <sub>DD</sub> = 15V, V <sub>GS</sub> = 4.5V I <sub>D</sub> = 7.0A  Q2 V <sub>DD</sub> = 15V, V <sub>GS</sub> = 4.5V I <sub>D</sub> = 8.8A Clamped Inductive Load		
		Q2	—	8.0	—				
t <sub>r</sub>	Rise Time	Q1	—	9.3	—				
		Q2	—	14	—				
t <sub>d(off)</sub>	Turn-Off Delay Time	Q1	—	8.0	—				
		Q2	—	13	—				
t <sub>f</sub>	Fall Time	Q1	—	3.4	—				
		Q2	—	5.3	—				
C <sub>iss</sub>	Input Capacitance	Q1	—	850	—			pF	V <sub>GS</sub> = 0V V <sub>DS</sub> = 15V f = 1.0MHz
		Q2	—	1790	—				
C <sub>oss</sub>	Output Capacitance	Q1	—	190	—				
		Q2	—	390	—				
C <sub>rss</sub>	Reverse Transfer Capacitance	Q1	—	88	—				
		Q2	—	190	—				

**Avalanche Characteristics**

	Parameter		Typ.	Q1 Max.	Q2 Max.	Units
E <sub>AS</sub>	Single Pulse Avalanche Energy ②		—	10	15	mJ
I <sub>AR</sub>	Avalanche Current ①		—	7.0	8.8	A

**Diode Characteristics**

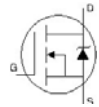
	Parameter		Min.	Typ.	Max.	Units	Conditions	
I <sub>S</sub>	Continuous Source Current (Body Diode)	Q1	—	—	2.8	A	MOSFET symbol showing the integral reverse p-n junction diode. 	
		Q2	—	—	2.8			
I <sub>SM</sub>	Pulsed Source Current (Body Diode) ①	Q1	—	—	76	A		
		Q2	—	—	85			
V <sub>SD</sub>	Diode Forward Voltage	Q1	—	—	1.0	V		T <sub>J</sub> = 25°C, I <sub>S</sub> = 7.3A, V <sub>GS</sub> = 0V ③
		Q2	—	—	1.0			T <sub>J</sub> = 25°C, I <sub>S</sub> = 8.8A, V <sub>GS</sub> = 0V ③
t <sub>rr</sub>	Reverse Recovery Time	Q1	—	12	18	ns	Q1 T <sub>J</sub> = 25°C, I <sub>F</sub> = 7.0A, V <sub>DD</sub> = 15V, di/dt = 100A/μs ③	
		Q2	—	16	24			
Q <sub>rr</sub>	Reverse Recovery Charge	Q1	—	4.1	6.1	nC	Q2 T <sub>J</sub> = 25°C, I <sub>F</sub> = 8.8A, V <sub>DD</sub> = 15V, di/dt = 100A/μs ③	
		Q2	—	5.9	8.9			

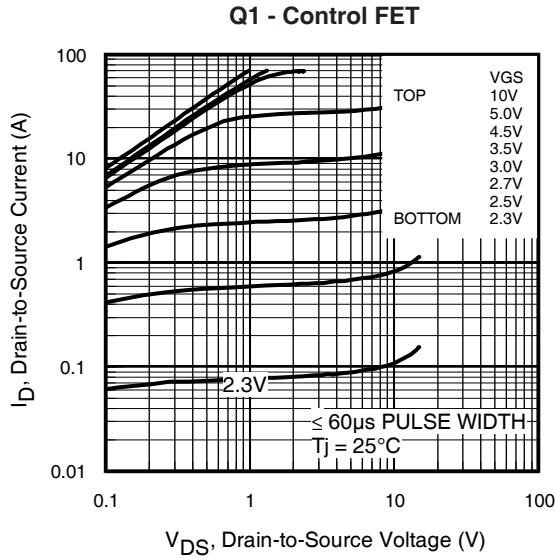
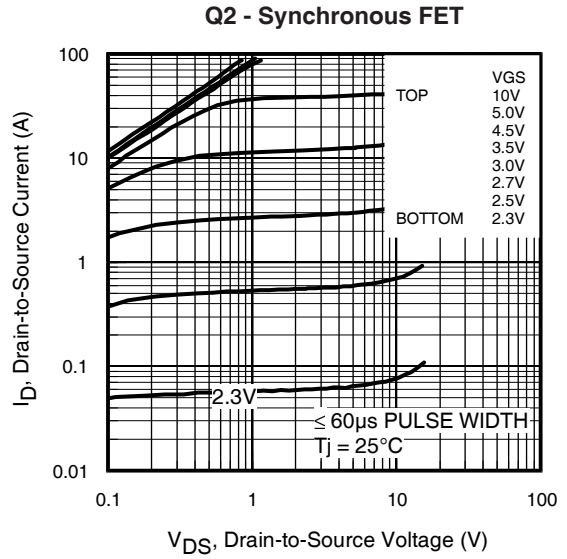
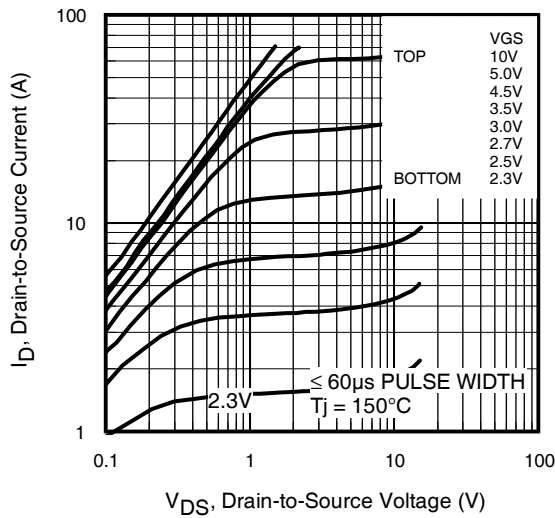
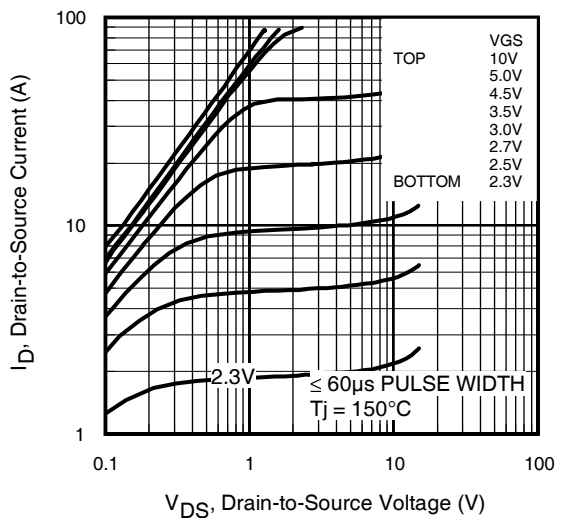
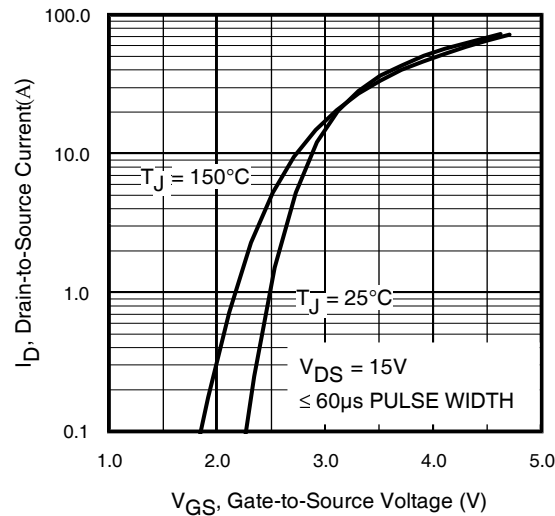
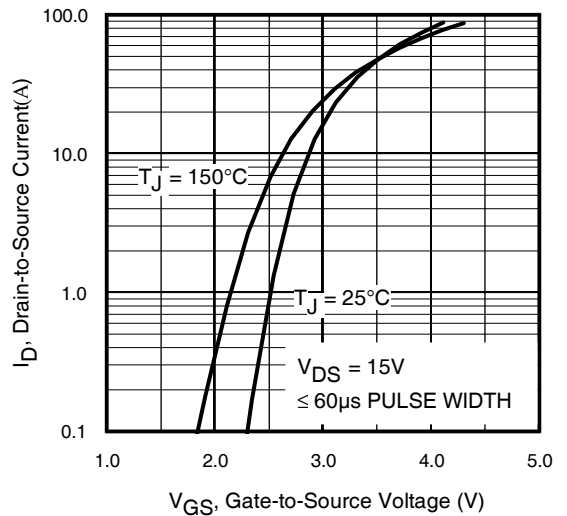
**Typical Characteristics**

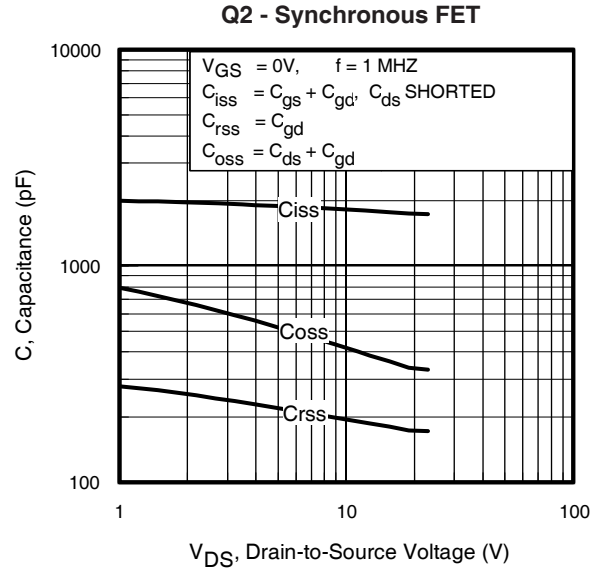
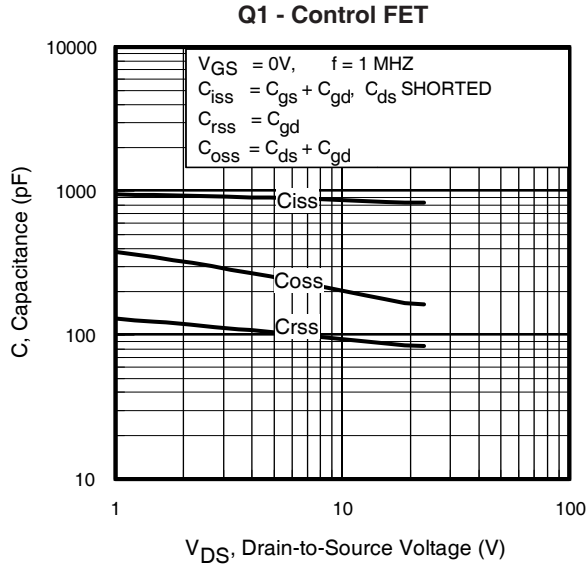
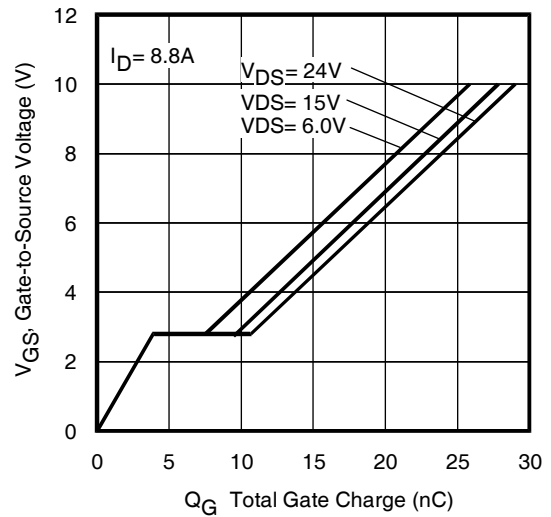
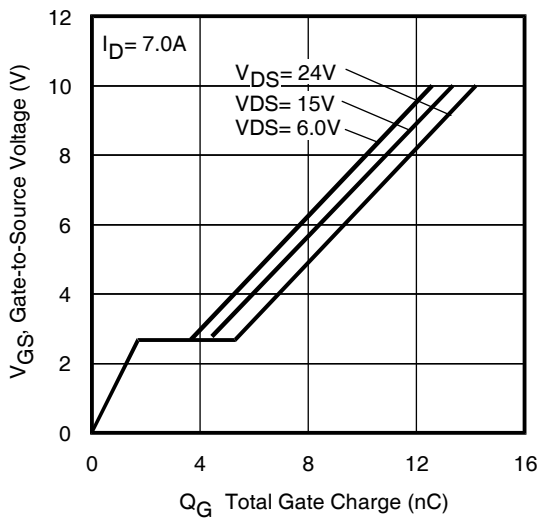
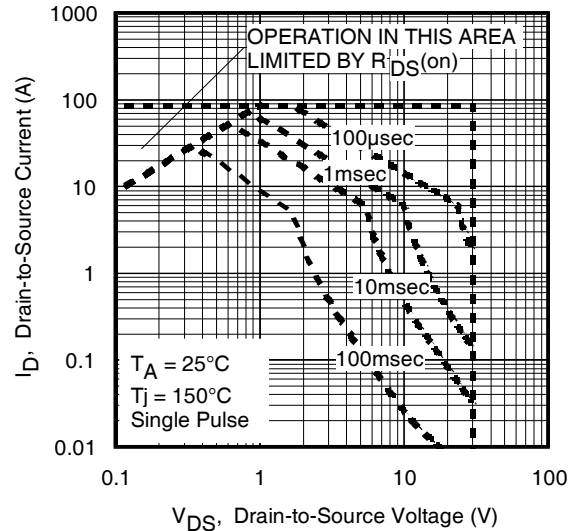
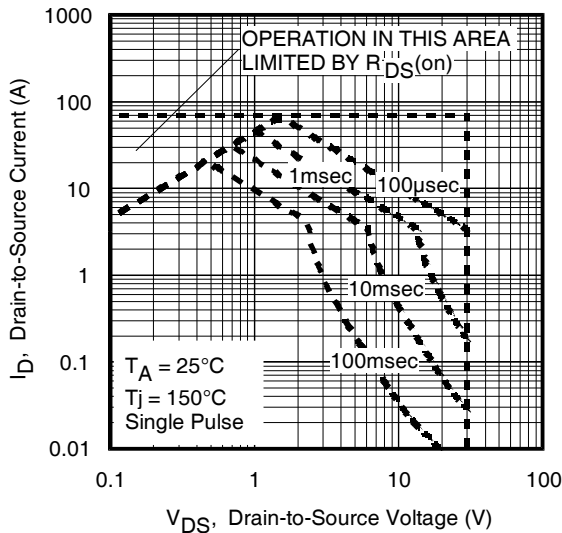
**Fig 1. Typical Output Characteristics**

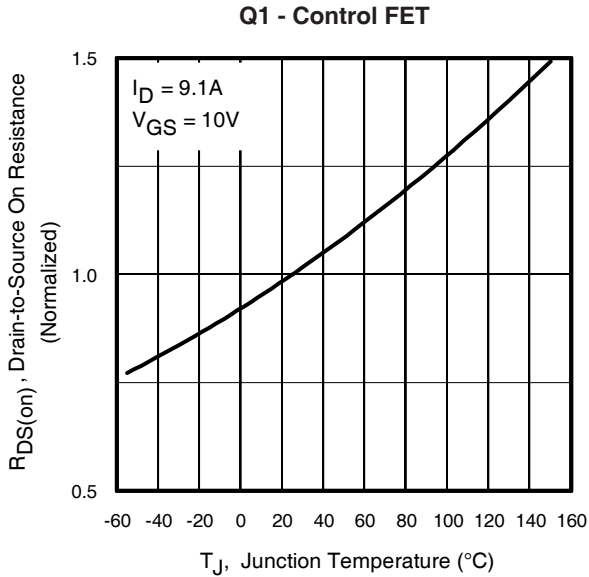
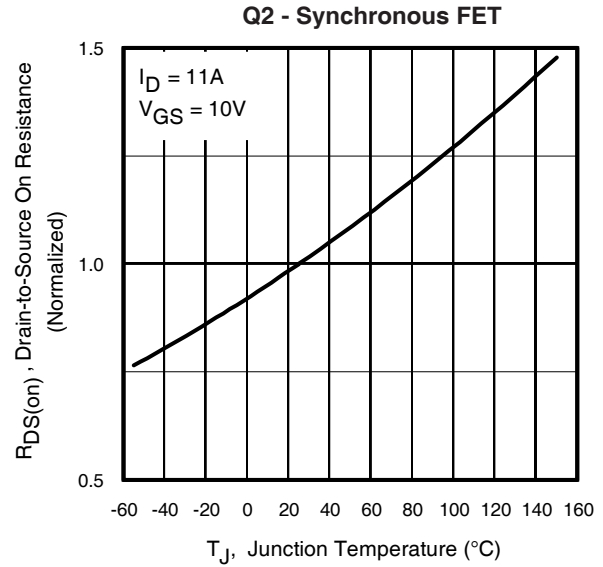
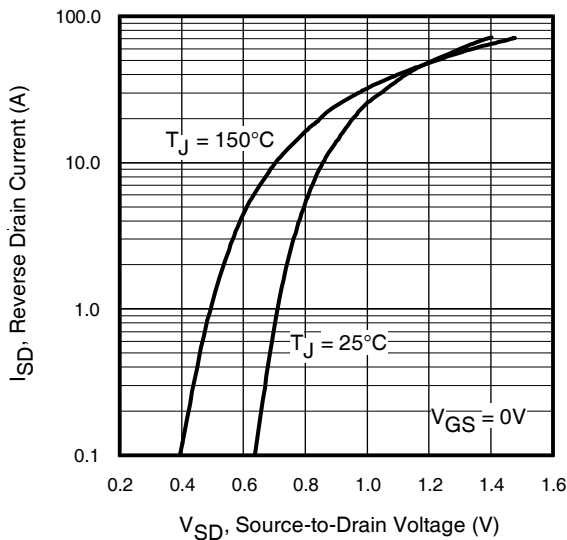
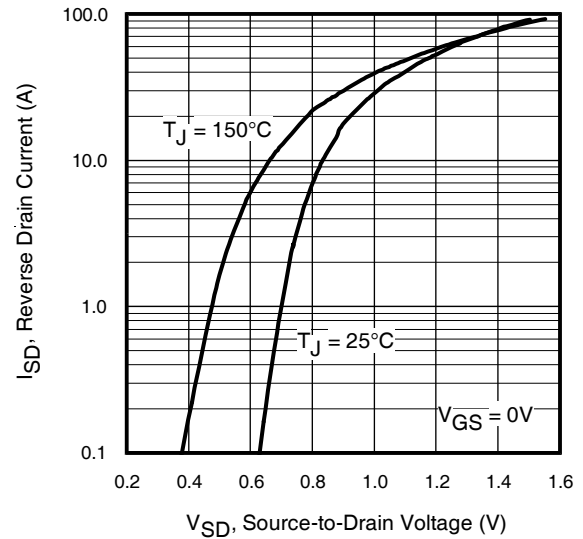
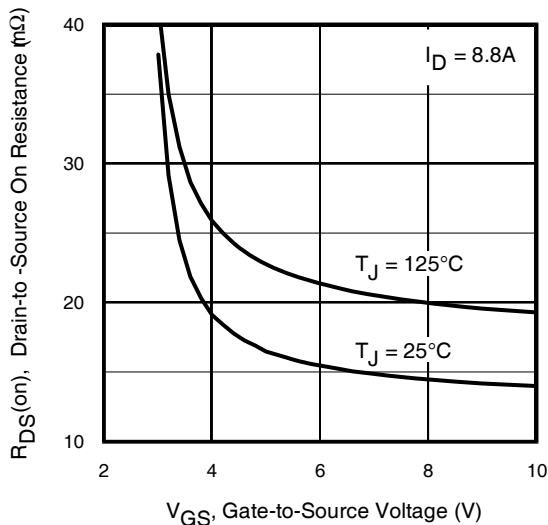
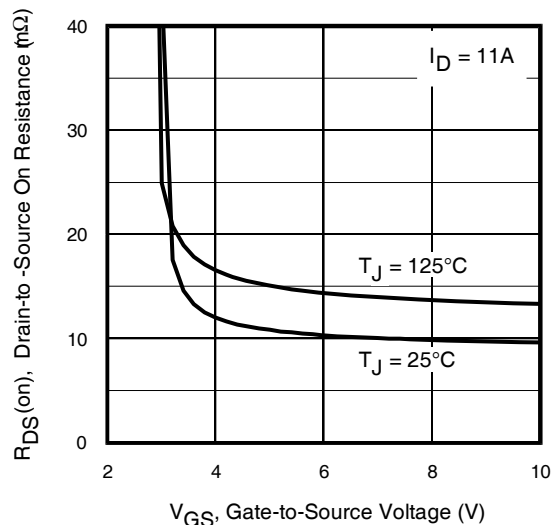
**Fig 2. Typical Output Characteristics**

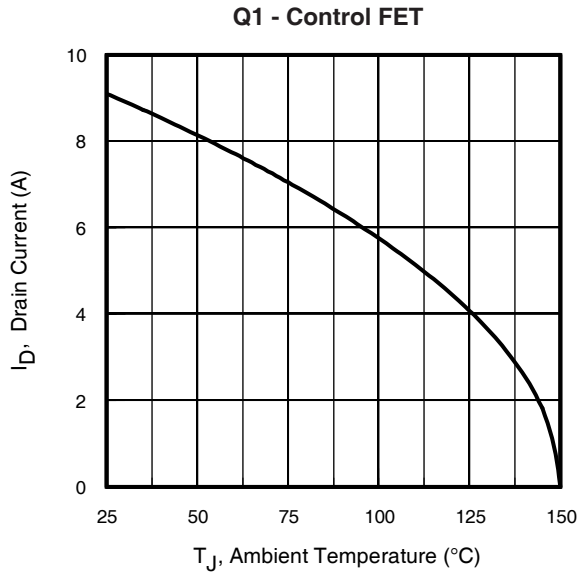
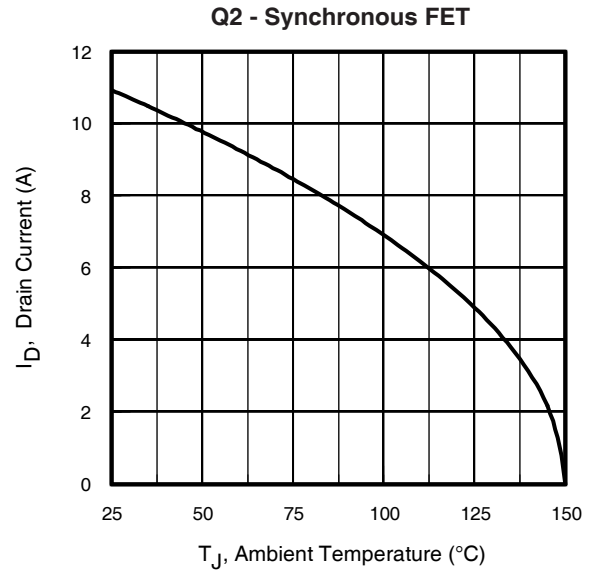
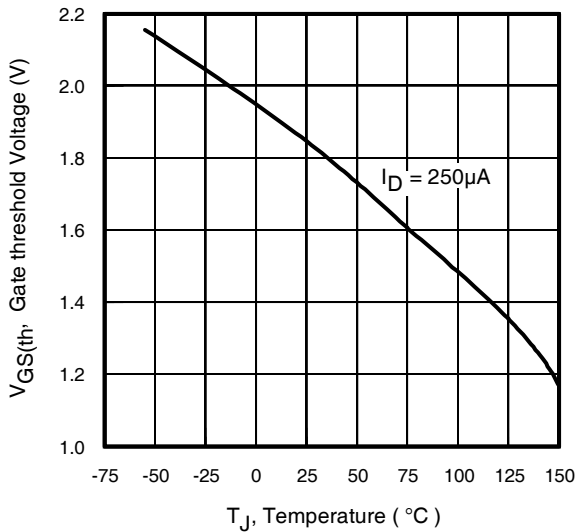
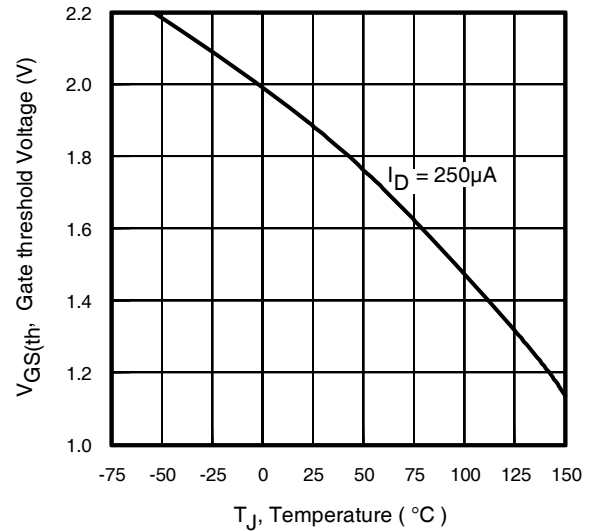
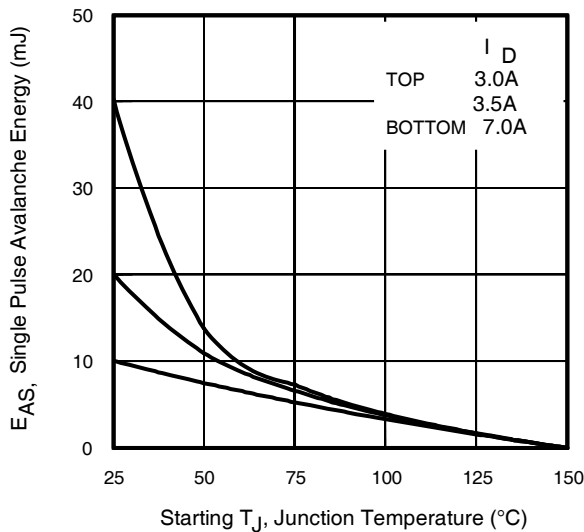
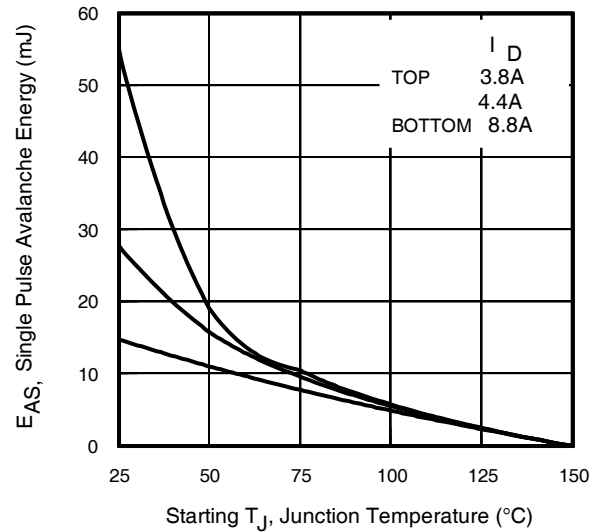
**Fig 3. Typical Output Characteristics**

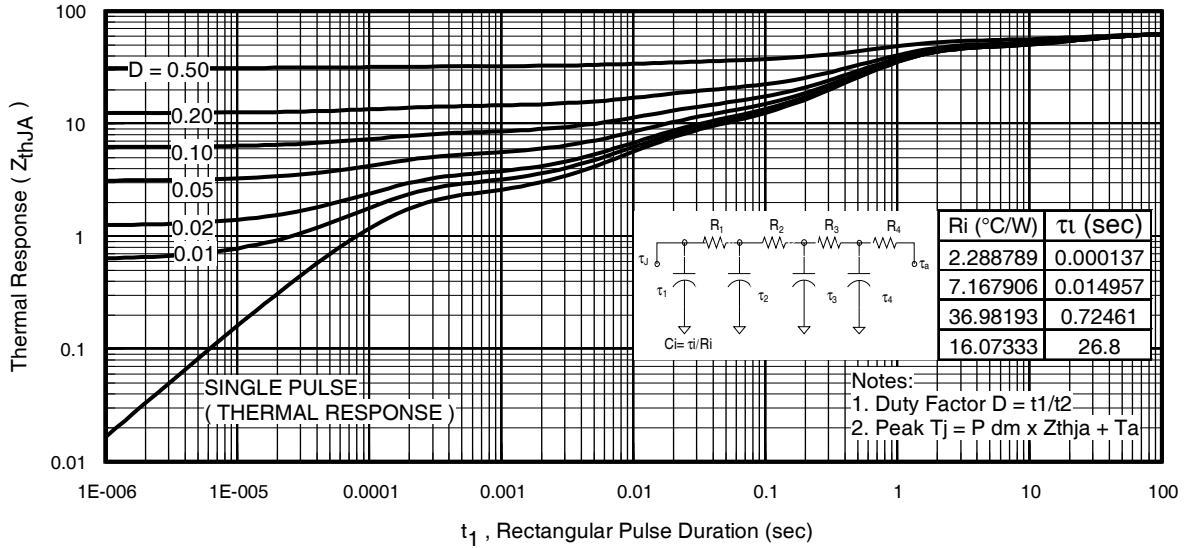
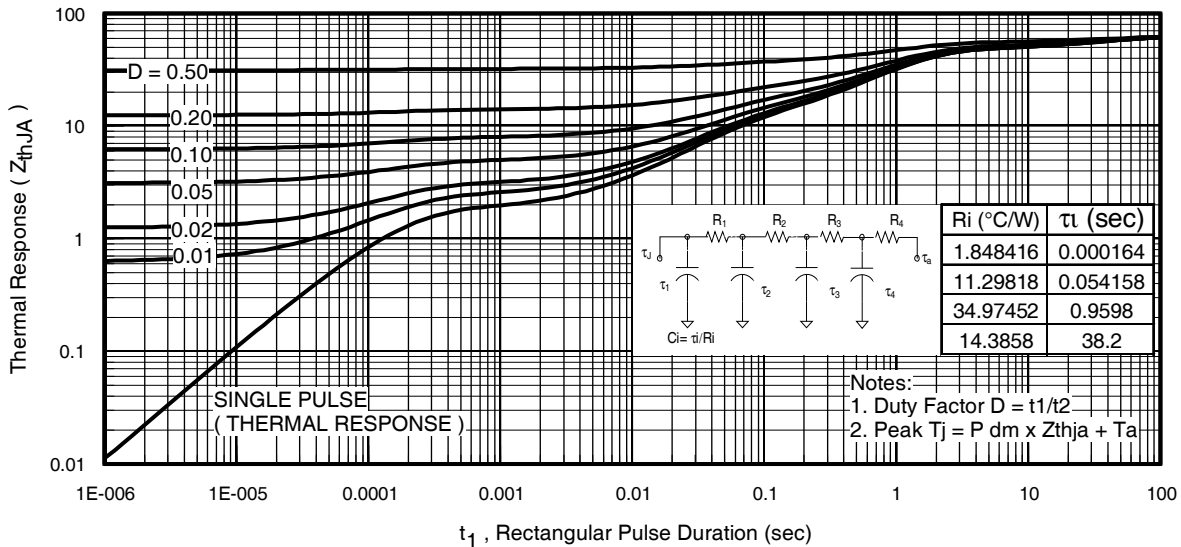
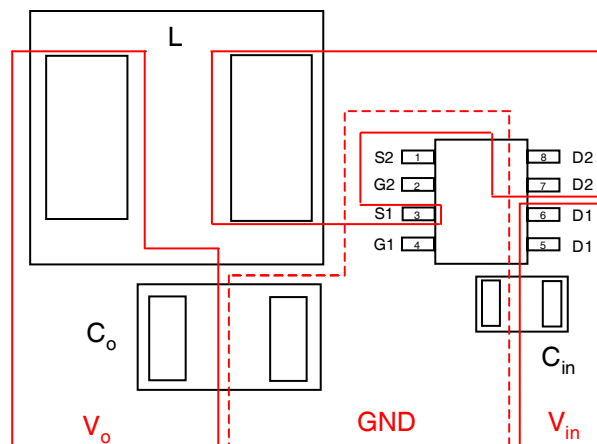
**Fig 4. Typical Output Characteristics**

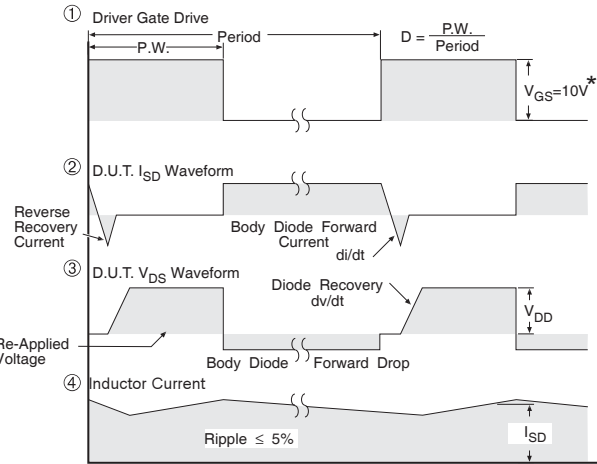
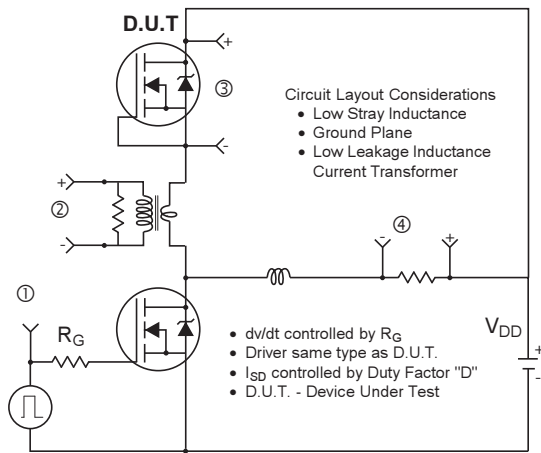
**Fig 5. Typical Transfer Characteristics**

**Fig 6. Typical Transfer Characteristics**

**Typical Characteristics**

**Fig 7. Typical Capacitance vs. Drain-to-Source Voltage** **Fig 8. Typical Capacitance vs. Drain-to-Source Voltage**

**Fig 9. Typical Gate Charge vs. Gate-to-Source Voltage**
**Fig 10. Typical Gate Charge vs. Gate-to-Source Voltage**

**Fig 11. Maximum Safe Operating Area**
**Fig 12. Maximum Safe Operating Area**

**Typical Characteristics**

**Fig 13.** Normalized On-Resistance vs. Temperature

**Fig 14.** Normalized On-Resistance vs. Temperature

**Fig 15.** Typical Source-Drain Diode Forward Voltage

**Fig 16.** Typical Source-Drain Diode Forward Voltage

**Fig 17.** Typical On-Resistance vs. Gate Voltage

**Fig 18.** Typical On-Resistance vs. Gate Voltage

**Typical Characteristics**

**Fig 19.** Maximum Drain Current vs. Ambient Temp.

**Fig 20.** Maximum Drain Current vs. Ambient Temp.

**Fig 21.** Threshold Voltage vs. Temperature

**Fig 22.** Threshold Voltage vs. Temperature

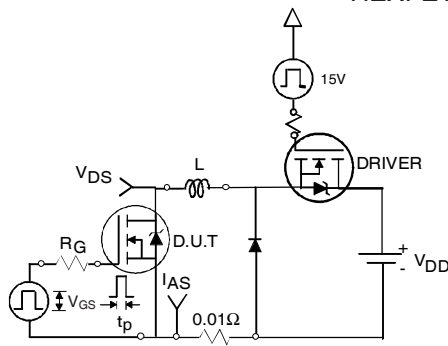
**Fig 23.** Maximum Avalanche Energy vs. Drain Current

**Fig 24.** Maximum Avalanche Energy vs. Drain Current

**Fig 25. Maximum Effective Transient Thermal Impedance, Junction-to-Ambient (Q1)**

**Fig 26. Maximum Effective Transient Thermal Impedance, Junction-to-Ambient (Q2)**

**Fig 27. Layout Diagram**



\*  $V_{GS} = 5V$  for Logic Level Devices

**Fig 28. Peak Diode Recovery  $dv/dt$  Test Circuit for N-Channel HEXFET® Power MOSFETs**



**Fig 29a. Unclamped Inductive Test Circuit**

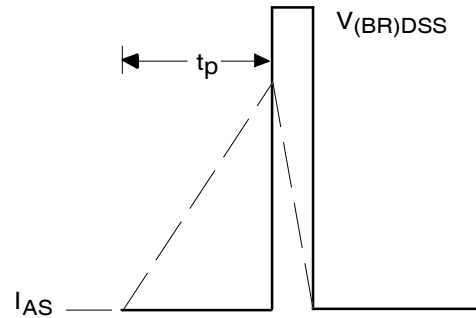

**Fig 29b. Unclamped Inductive Waveforms**

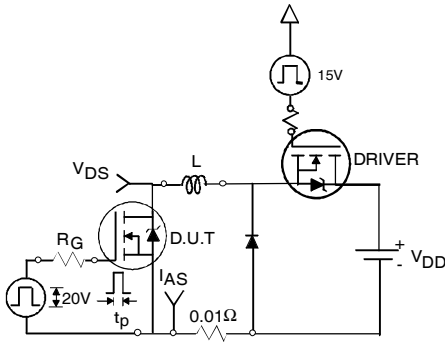

**Fig 30a. Switching Time Test Circuit**

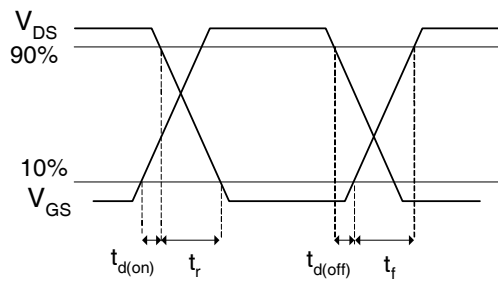

**Fig 30b. Switching Time Waveforms**

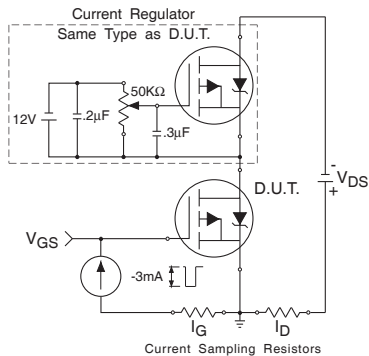

**Fig 31a. Gate Charge Test Circuit**

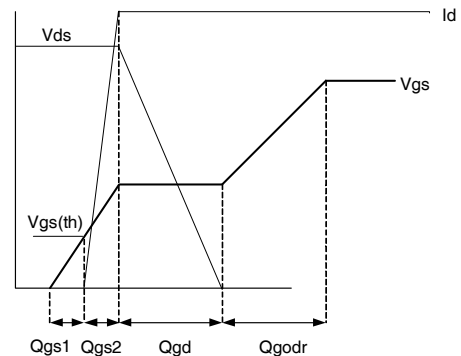
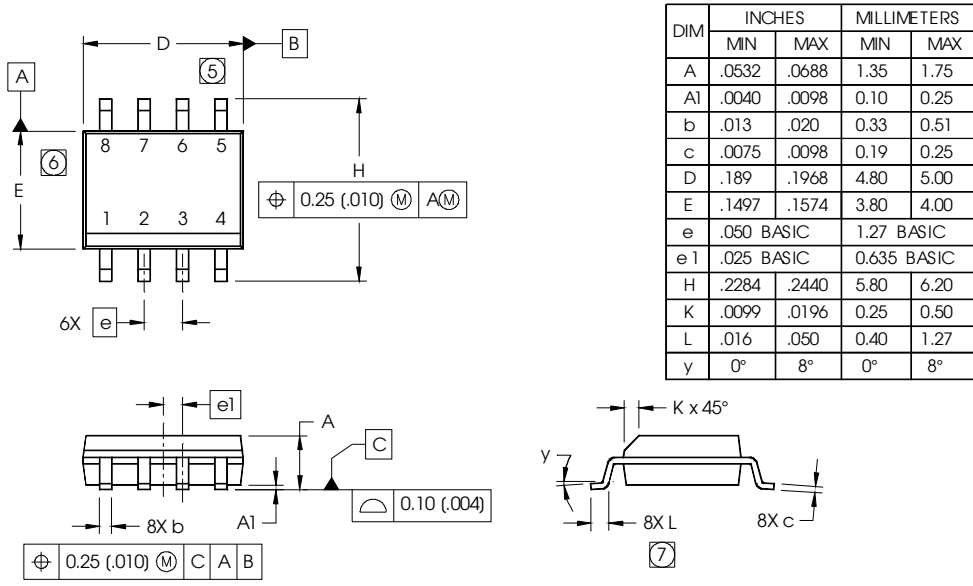

**Fig 31b. Gate Charge Waveform**



# SO-8 Package Outline (MOSFET & Fetky)

Dimensions are shown in millimeters (inches)



**NOTES:**

1. DIMENSIONING & TOLERANCING PER ASME Y14.5M-1994.
2. CONTROLLING DIMENSION: MILLIMETER
3. DIMENSIONS ARE SHOWN IN MILLIMETERS (INCHES).
4. OUTLINE CONFORMS TO JEDEC OUTLINE MS-012AA.
- ⑤ DIMENSION DOES NOT INCLUDE MOLD PROTRUSIONS. MOLD PROTRUSIONS NOT TO EXCEED 0.15 (.006).
- ⑥ DIMENSION DOES NOT INCLUDE MOLD PROTRUSIONS. MOLD PROTRUSIONS NOT TO EXCEED 0.25 (.010).
- ⑦ DIMENSION IS THE LENGTH OF LEAD FOR SOLDERING TO A SUBSTRATE.

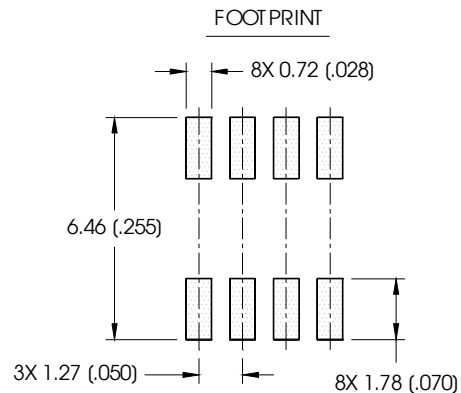

## SO-8 Part Marking Information

EXAMPLE: THIS IS AN IRF7101 (MOSFET)

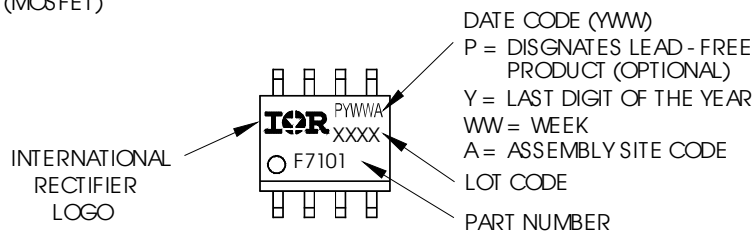

Note: For the most current drawing please refer to IR website at: <http://www.irf.com/package/>

### SO-8 Tape and Reel

Dimensions are shown in millimeters (inches)

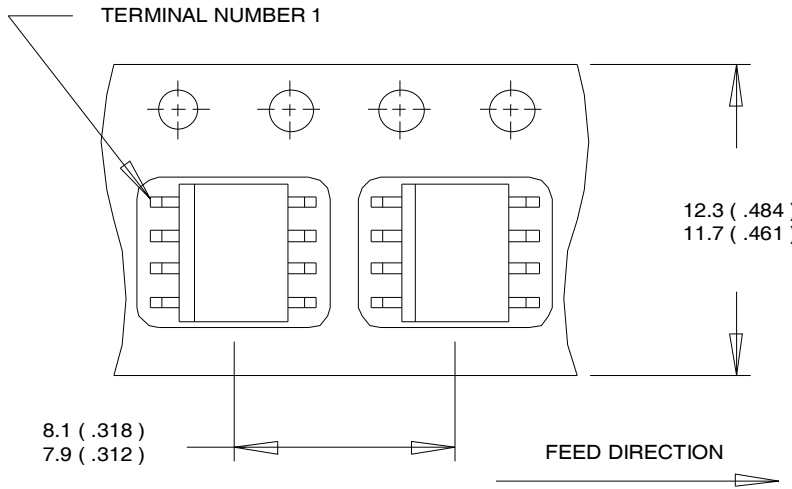

**NOTES:**

1. CONTROLLING DIMENSION : MILLIMETER.
2. ALL DIMENSIONS ARE SHOWN IN MILLIMETERS(INCHES).
3. OUTLINE CONFORMS TO EIA-481 & EIA-541.

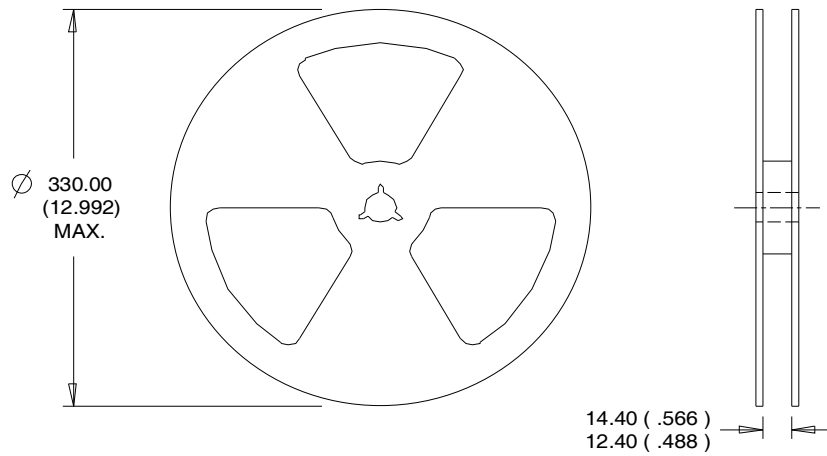

**NOTES :**

1. CONTROLLING DIMENSION : MILLIMETER.
2. OUTLINE CONFORMS TO EIA-481 & EIA-541.

Note: For the most current drawing please refer to IR website at: <http://www.irf.com/package/>

**Qualification information<sup>†</sup>**

Qualification level	Industrial (per JEDEC JESD47F <sup>††</sup> guidelines)	
Moisture Sensitivity Level	SO-8	MSL1 (per JEDEC J-STD-020D <sup>††</sup> )
RoHS compliant	Yes	

<sup>†</sup> Qualification standards can be found at International Rectifier's web site: <http://www.irf.com/product-info/reliability>
<sup>††</sup> Applicable version of JEDEC standard at the time of product release

**Notes:**

- ① Repetitive rating; pulse width limited by max. junction temperature.
- ② Starting  $T_J = 25^\circ\text{C}$ , Q1:  $L = 0.41\text{mH}$ ,  $R_G = 25\Omega$ ,  $I_{AS} = 7.0\text{A}$ ; Q2:  $L = 0.38\text{mH}$ ,  $R_G = 25\Omega$ ,  $I_{AS} = 8.8\text{A}$ .
- ③ Pulse width  $\leq 400\mu\text{s}$ ; duty cycle  $\leq 2\%$ .
- ④ When mounted on 1 inch square copper board.
- ⑤  $R_\theta$  is measured at  $T_J$  approximately  $90^\circ\text{C}$ .

**Revision History**

Date	Comments
10/16/2014	<ul style="list-style-type: none"> <li>• Corrected part number from "IRF7907VPbF-1" to "IRF7907VTRPbF-1" -all pages</li> <li>• Removed the "IRF7907VPbF-1" bulk part number from ordering information on page1</li> </ul>