

HEXFET® Power MOSFET

| | | |
|--|-------------|-----------|
| V_{DS} | 30 | V |
| $R_{DS(on) max}$ (@ $V_{GS} = 4.5V$) | 14 | mΩ |
| Q_g (typical) | 17 | nC |
| I_D (@ $T_A = 25^\circ C$) | 10.8 | A |

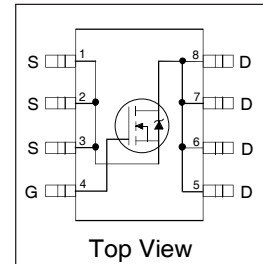

Features

| |
|---|
| Industry-standard pinout SO-8 Package |
| Compatible with Existing Surface Mount Techniques |
| RoHS Compliant, Halogen-Free |
| MSL1, Industrial qualification |



Benefits

| |
|----------------------------|
| Multi-Vendor Compatibility |
| Easier Manufacturing |
| Environmentally Friendlier |
| Increased Reliability |

| Base Part Number | Package Type | Standard Pack | | Orderable Part Number |
|------------------|--------------|---------------|----------|-----------------------|
| | | Form | Quantity | |
| IRF7811AVPbF-1 | SO-8 | Tube/Bulk | 95 | IRF7811AVPbF-1 |
| | | Tape and Reel | 4000 | IRF7811AVTRPbF-1 |

Absolute Maximum Ratings

| Parameter | Symbol | IRF7811AV | Units |
|---|--------------------|------------|-------|
| Drain-to-Source Voltage | V_{DS} | 30 | V |
| Gate-to-Source Voltage | V_{GS} | ±20 | |
| Continuous Output Current ($V_{GS} \geq 4.5V$) | $T_A = 25^\circ C$ | 10.8 | A |
| | $T_L = 90^\circ C$ | 11.8 | |
| Pulsed Drain Current ① | I_{DM} | 100 | |
| Power Dissipation ③ | $T_A = 25^\circ C$ | 2.5 | W |
| | $T_L = 90^\circ C$ | 3.0 | |
| Junction & Storage Temperature Range | T_J, T_{STG} | -55 to 150 | °C |
| Continuous Source Current (Body Diode) | I_S | 2.5 | A |
| Pulsed Source Current ① | I_{SM} | 50 | |

Thermal Resistance

| Parameter | Symbol | Typ | Max | Units |
|--------------------------------|-----------------|-----|-----|-------|
| Maximum Junction-to-Ambient ③⑥ | $R_{\theta JA}$ | --- | 50 | °C/W |
| Maximum Junction-to-Lead ⑥ | $R_{\theta JL}$ | --- | 20 | |

Electrical Characteristics

| Parameter | Symbol | Min | Typ | Max | Units | Conditions |
|--|---------------|-----|------|-----------|------------|--|
| Drain-to-Source Breakdown Voltage | $V_{(BR)DSS}$ | 30 | — | — | V | $V_{GS} = 0V, I_D = 250\mu A$ |
| Static Drain-to-Source On-Resistance | $R_{DS(on)}$ | — | 11 | 14 | m Ω | $V_{GS} = 4.5V, I_D = 15A$ ② |
| Gate Threshold Voltage | $V_{GS(th)}$ | 1.0 | — | 3.0 | V | $V_{DS} = V_{GS}, I_D = 250\mu A$ |
| Drain-to-Source Leakage Current | I_{DSS} | — | — | 50 | μA | $V_{DS} = 30V, V_{GS} = 0V$ |
| | | — | — | 20 | μA | $V_{DS} = 24V, V_{GS} = 0V$ |
| | | — | — | 100 | mA | $V_{DS} = 24V, V_{GS} = 0V, T_J = 100^\circ C$ |
| Gate-to-Source Leakage Current | I_{GSS} | — | — | ± 100 | nA | $V_{GS} = \pm 20V$ |
| Total Gate Charge, Control FET | Q_g | — | 17 | 26 | nC | $V_{DS} = 24V, I_D = 15A, V_{GS} = 5.0V$ |
| Total Gate Charge, Synch FET | Q_g | — | 14 | 21 | nC | $V_{GS} = 5.0V, V_{DS} < 100mV$ |
| Pre-V _{th} Gate-to-Source Charge | Q_{gs1} | — | 3.4 | — | | $V_{DS} = 16V, I_D = 15A$ |
| Post-V _{th} Gate-to-Source Charge | Q_{gs2} | — | 1.6 | — | | |
| Gate-to-Drain ("Miller") Charge | Q_{gd} | — | 5.1 | — | | |
| Switch Charge ($Q_{gs2} + Q_{gd}$) | Q_{SW} | — | 6.7 | — | | |
| Output Charge | Q_{OSS} | — | 8.1 | 12 | | |
| Gate Resistance | R_G | 0.5 | — | 4.4 | Ω | |
| Turn-On Delay Time | $t_{d(on)}$ | — | 8.6 | — | ns | $V_{DD} = 16V$ |
| Rise Time | t_r | — | 21 | — | | $I_D = 15A$ |
| Turn-Off Delay Time | $t_{d(off)}$ | — | 43 | — | | $V_{GS} = 5.0V$ |
| Fall Time | t_f | — | 10 | — | | Clamped Inductive Load |
| Input Capacitance | C_{iss} | — | 1801 | — | pF | $V_{GS} = 0V$ |
| Output Capacitance | C_{oss} | — | 723 | — | | $V_{DS} = 10V$ |
| Reverse Transfer Capacitance | C_{rss} | — | 46 | — | | |

Diode Characteristics

| Parameter | Symbol | Min | Typ | Max | Units | Conditions |
|---|----------|-----|-----|-----|-------|---|
| Diode Forward Voltage | V_{SD} | — | — | 1.3 | V | $T_J = 25^\circ C, I_S = 15A$ ②, $V_{GS} = 0V$ |
| Reverse Recovery Charge ④ | Q_{rr} | — | 50 | — | nC | $di/dt = 700A/\mu s$ $V_{DD} = 16V, V_{GS} = 0V, I_D = 15A$ |
| Reverse Recovery Charge (with Parallel Schottsky) ④ | Q_{rr} | — | 43 | — | nC | $di/dt = 700A/\mu s$, (with 10BQ040) $V_{DD} = 16V, V_{GS} = 0V, I_D = 15A$ |

Notes:

- ① Repetitive rating; pulse width limited by max. junction temperature.
- ② Pulse width $\leq 400 \mu s$; duty cycle $\leq 2\%$.
- ③ When mounted on 1 inch square copper board, $t < 10$ sec.
- ④ Typ = measured - Q_{OSS}
- ⑤ Typical values of $R_{DS(on)}$ measured at $V_{GS} = 4.5V$, Q_G , Q_{SW} and Q_{OSS} measured at $V_{GS} = 5.0V$, $I_F = 15A$.
- ⑥ R_{θ} is measured at T_J approximately $90^\circ C$

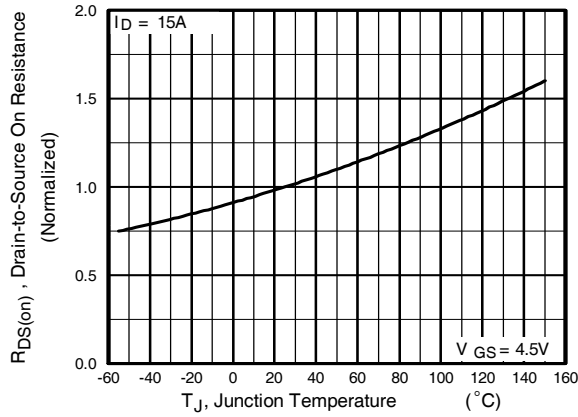

Figure 1. Normalized On-Resistance vs. Temperature

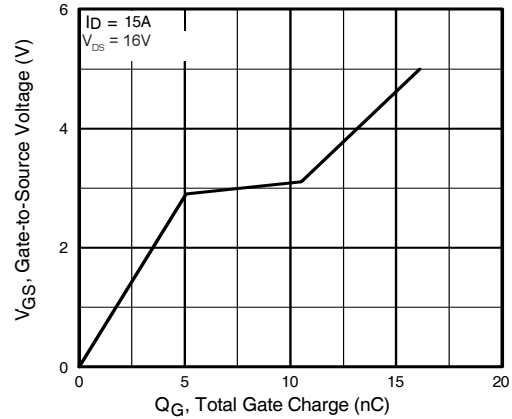

Figure 2. Gate-to-Source Voltage vs. Typical Gate Charge

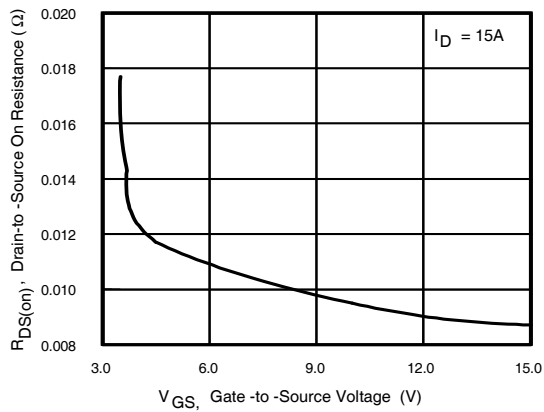
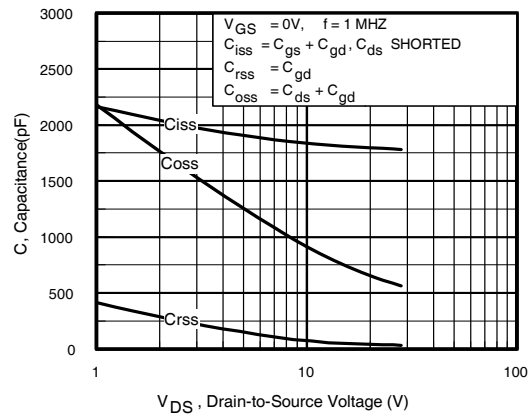

 Figure 3. Typical $R_{DS(on)}$ vs. Gate-to-Source Voltage

Figure 4. Typical Capacitance vs. Drain-to-Source Voltage

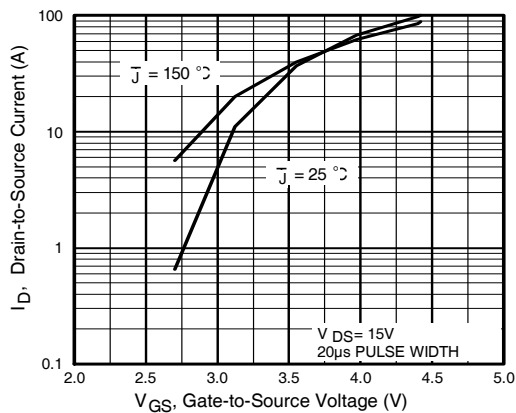

Figure 5. Typical Transfer Characteristics

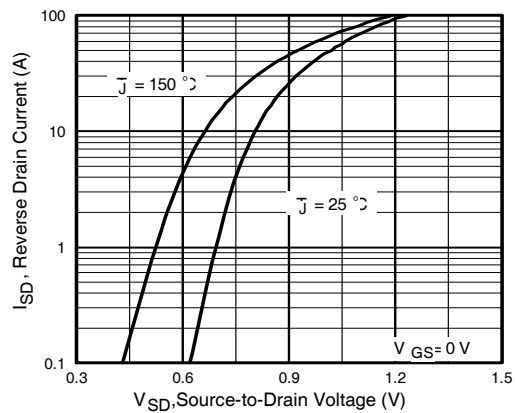

Figure 6. Typical Source-Drain Diode Forward Voltage

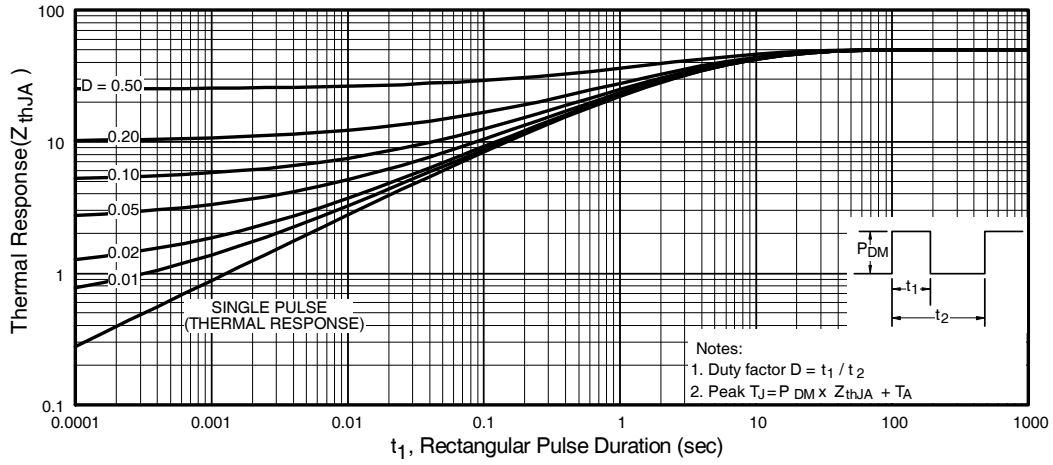

Figure 7. Maximum Effective Transient Thermal Impedance, Junction-to-Ambient

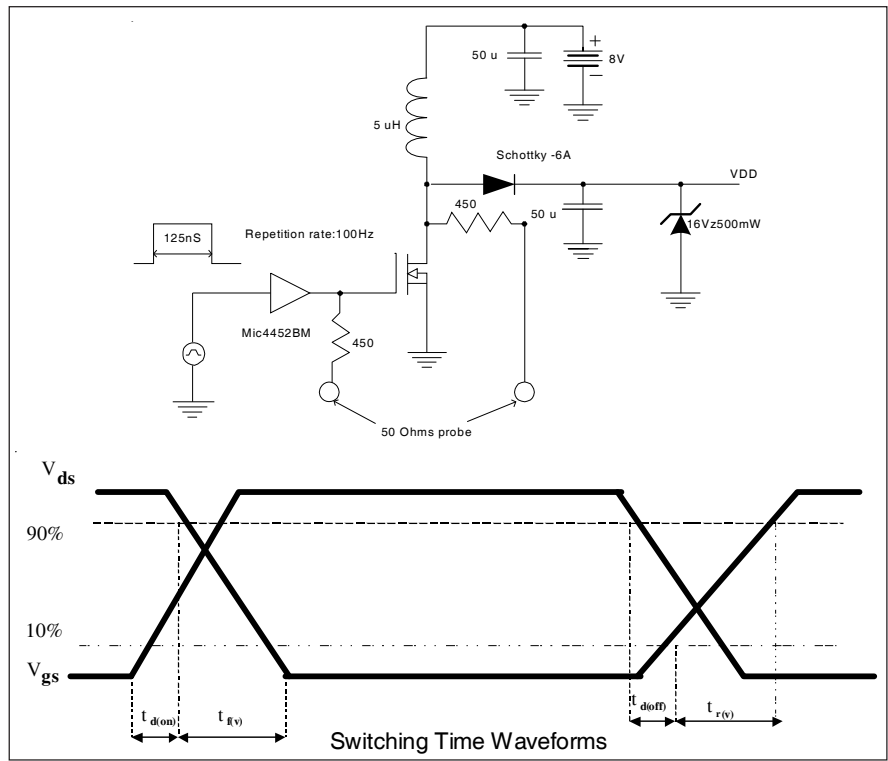
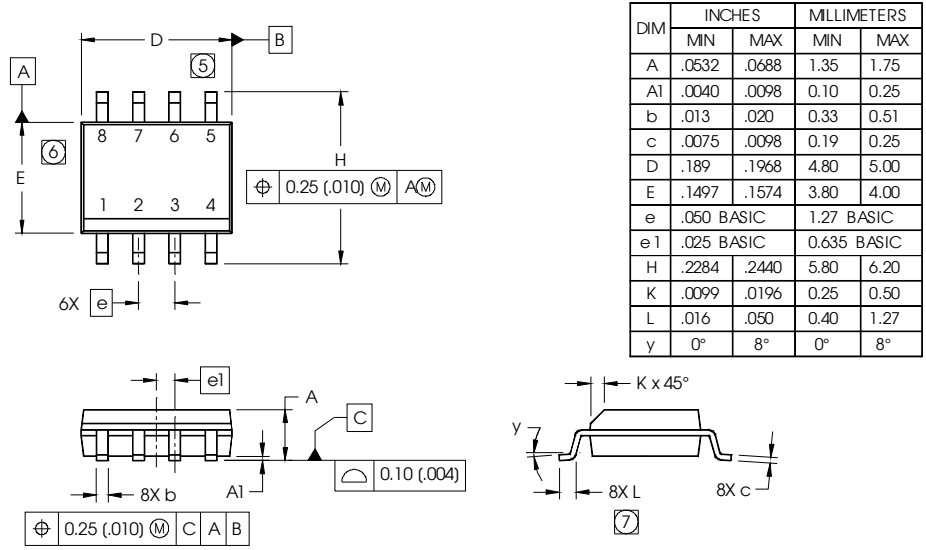

Figure 8. Clamped Inductive load test diagram and switching waveform



SO-8 Package Outline

Dimensions are shown in millimeters (inches)



NOTES:

1. DIMENSIONING & TOLERANCING PER ASME Y14.5M-1994.
2. CONTROLLING DIMENSION: MILLIMETER
3. DIMENSIONS ARE SHOWN IN MILLIMETERS (INCHES).
4. OUTLINE CONFORMS TO JEDEC OUTLINE MS-012AA.
5. DIMENSION DOES NOT INCLUDE MOLD PROTRUSIONS. MOLD PROTRUSIONS NOT TO EXCEED 0.15 (.006).
6. DIMENSION DOES NOT INCLUDE MOLD PROTRUSIONS. MOLD PROTRUSIONS NOT TO EXCEED 0.25 (.010).
7. DIMENSION IS THE LENGTH OF LEAD FOR SOLDERING TO A SUBSTRATE.

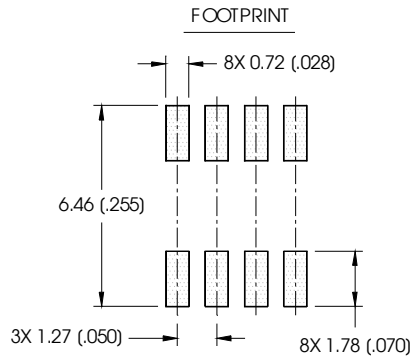

SO-8 Part Marking

EXAMPLE: THIS IS AN IRF7101 (MOSFET)

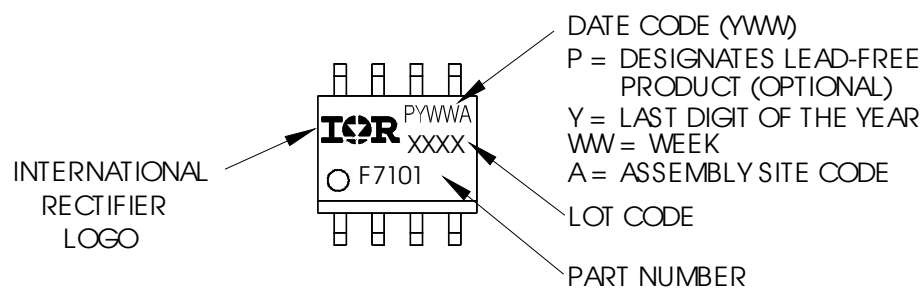

Note: For the most current drawing please refer to IR website at: <http://www.irf.com/package/>

SO-8 Tape and Reel

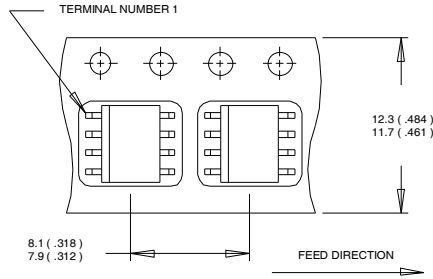

- NOTES:
 1. CONTROLLING DIMENSION : MILLIMETER.
 2. ALL DIMENSIONS ARE SHOWN IN MILLIMETERS(INCHES).
 3. OUTLINE CONFORMS TO EIA-481 & EIA-541.

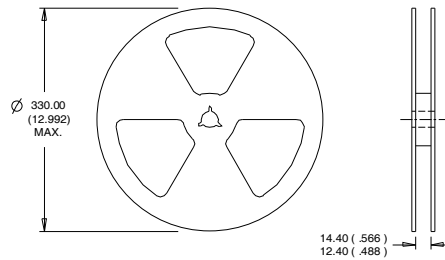

- NOTES:
 1. CONTROLLING DIMENSION : MILLIMETER.
 2. OUTLINE CONFORMS TO EIA-481 & EIA-541.

Note: For the most current drawing please refer to IR website at: <http://www.irf.com/package/>

Qualification information[†]

| | | |
|----------------------------|--|---|
| Qualification level | Industriid (per JEDEC JESD47F ^{††} guidelines) | |
| Moisture Sensitivity Level | SO-8 | MSL1 (per JEDEC J-STD-020D ^{††}) |
| RoHS compliant | Yes | |

[†] Qualification standards can be found at International Rectifier's web site: <http://www.irf.com/product-info/reliability>
^{††} Applicable version of JEDEC standard at the time of product release