

HEXFET® Power MOSFET

V_{DS}	30	V
$R_{DS(on) \max}$ (@ $V_{GS} = 10V$)	0.10	Ω
$R_{DS(on) \max}$ (@ $V_{GS} = 4.5V$)	0.20	
Q_g (typical)	6.4	nC
I_D (@ $T_A = 25^\circ C$)	3.2	A

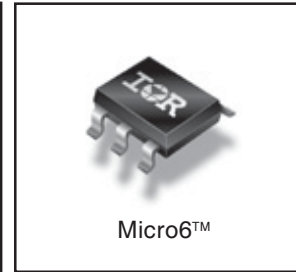
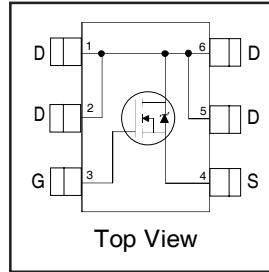

Features

Industry-standard pinout Micro-6 Package
Compatible with Existing Surface Mount Techniques
RoHS Compliant, Halogen-Free
MSL1, Industrial qualification



Benefits

Multi-Vendor Compatibility
Easier Manufacturing
Environmentally Friendlier
Increased Reliability

Base Part Number	Package Type	Standard Pack		Orderable Part Number
		Form	Quantity	
IRLMS1503TRPbF-1	Micro6™	Tape and Reel	3000	IRLMS1503TRPbF-1

Absolute Maximum Ratings

	Parameter	Max.	Units
$I_D @ T_A = 25^\circ C$	Continuous Drain Current, $V_{GS} @ 10V$	3.2	A
$I_D @ T_A = 70^\circ C$	Continuous Drain Current, $V_{GS} @ 10V$	2.6	
I_{DM}	Pulsed Drain Current ①	18	
$P_D @ T_A = 25^\circ C$	Power Dissipation	1.7	W
	Linear Derating Factor	13	mW/°C
V_{GS}	Gate-to-Source Voltage	± 20	V
dv/dt	Peak Diode Recovery dv/dt ②	5.0	V/ns
T_J, T_{STG}	Junction and Storage Temperature Range	-55 to + 150	°C

Thermal Resistance Ratings

	Parameter	Min.	Typ.	Max	Units
$R_{\theta JA}$	Maximum Junction-to-Ambient ④	—	—	75	°C/W

Electrical Characteristics @ T_J = 25°C (unless otherwise specified)

	Parameter	Min.	Typ.	Max.	Units	Conditions
V _{(BR)DSS}	Drain-to-Source Breakdown Voltage	30	—	—	V	V _{GS} = 0V, I _D = 250μA
ΔV _{(BR)DSS/ΔT_J}	Breakdown Voltage Temp. Coefficient	—	0.037	—	V/°C	Reference to 25°C, I _D = 1mA
R _{DS(on)}	Static Drain-to-Source On-Resistance	—	—	0.100	Ω	V _{GS} = 10V, I _D = 2.2A ③
		—	—	0.20		V _{GS} = 4.5V, I _D = 1.1A ③
V _{GS(th)}	Gate Threshold Voltage	1.0	—	—	V	V _{DS} = V _{GS} , I _D = 250μA
g _{fs}	Forward Transconductance	1.1	—	—	S	V _{DS} = 10V, I _D = 1.1A
I _{DSS}	Drain-to-Source Leakage Current	—	—	1.0	μA	V _{DS} = 24V, V _{GS} = 0V
		—	—	25		V _{DS} = 24V, V _{GS} = 0V, T _J = 125°C
I _{GSS}	Gate-to-Source Forward Leakage	—	—	-100	nA	V _{GS} = -20V
	Gate-to-Source Reverse Leakage	—	—	100		V _{GS} = 20V
Q _g	Total Gate Charge	—	6.4	9.6	nC	I _D = 2.2A
Q _{gs}	Gate-to-Source Charge	—	1.1	1.7		V _{DS} = 24V
Q _{gd}	Gate-to-Drain ("Miller") Charge	—	1.9	2.8		V _{GS} = 10V, See Fig. 6 and 9 ③
t _{d(on)}	Turn-On Delay Time	—	4.6	—		V _{DD} = 15V
t _r	Rise Time	—	4.4	—	ns	I _D = 2.2A
t _{d(off)}	Turn-Off Delay Time	—	10	—		R _G = 6.0Ω
t _f	Fall Time	—	2.0	—		R _D = 6.7Ω, See Fig. 10 ③
C _{iss}	Input Capacitance	—	210	—	pF	V _{GS} = 0V
C _{oss}	Output Capacitance	—	90	—		V _{DS} = 25V
C _{rss}	Reverse Transfer Capacitance	—	32	—		f = 1.0MHz, See Fig. 5

Source-Drain Ratings and Characteristics

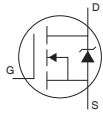
	Parameter	Min.	Typ.	Max.	Units	Conditions
I _S	Continuous Source Current (Body Diode)	—	—	1.7	A	MOSFET symbol showing the integral reverse p-n junction diode. 
I _{SM}	Pulsed Source Current (Body Diode) ①	—	—	18		
V _{SD}	Diode Forward Voltage	—	—	1.2	V	T _J = 25°C, I _S = 2.2A, V _{GS} = 0V ③
t _{rr}	Reverse Recovery Time	—	36	54	ns	T _J = 25°C, I _F = 2.2A
Q _{rr}	Reverse Recovery Charge	—	39	58	nC	di/dt = 100A/μs ③

Notes:

- ① Repetitive rating; pulse width limited by max. junction temperature. (See fig. 11)
- ② I_{SD} ≤ 2.2A, di/dt ≤ 150A/μs, V_{DD} ≤ V_{(BR)DSS}, T_J ≤ 150°C
- ③ Pulse width ≤ 300μs; duty cycle ≤ 2%.
- ④ Surface mounted on FR-4 board, t ≤ 5sec.

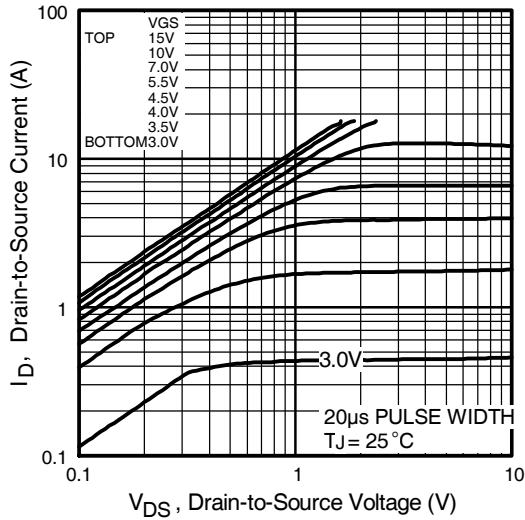
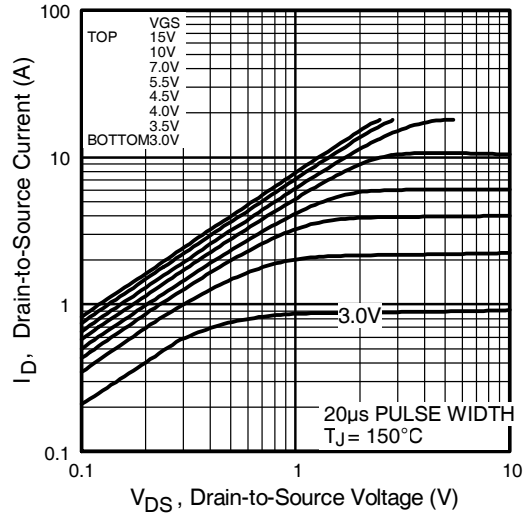
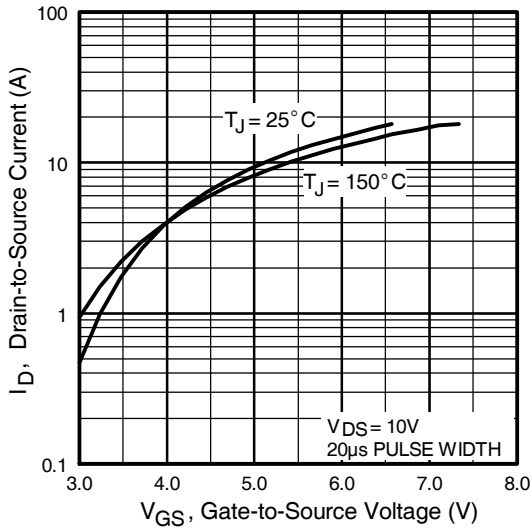
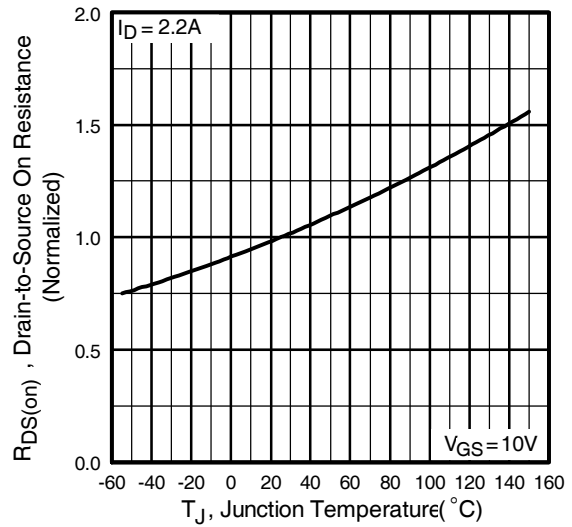
Fig 1. Typical Output Characteristics

Fig 2. Typical Output Characteristics

Fig 3. Typical Transfer Characteristics

Fig 4. Normalized On-Resistance Vs. Temperature

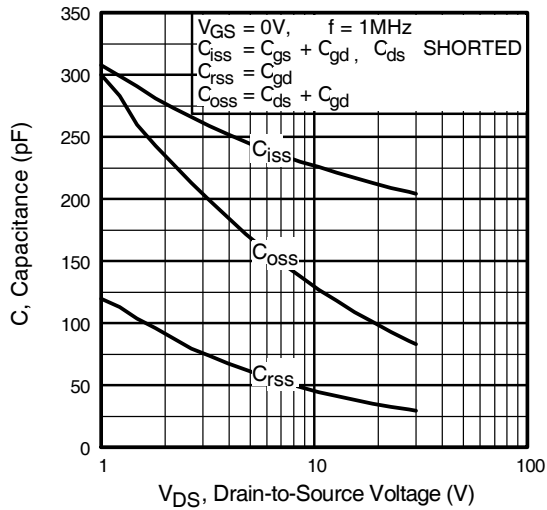

Fig 5. Typical Capacitance Vs. Drain-to-Source Voltage

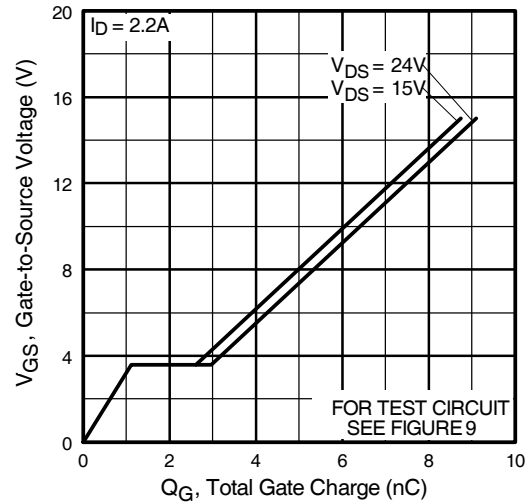

Fig 6. Typical Gate Charge Vs. Gate-to-Source Voltage

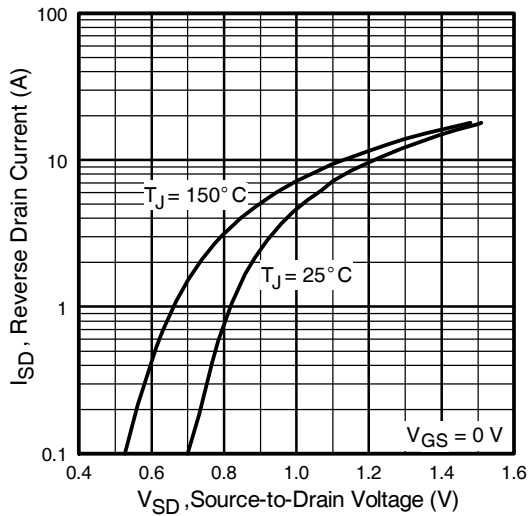

Fig 7. Typical Source-Drain Diode Forward Voltage

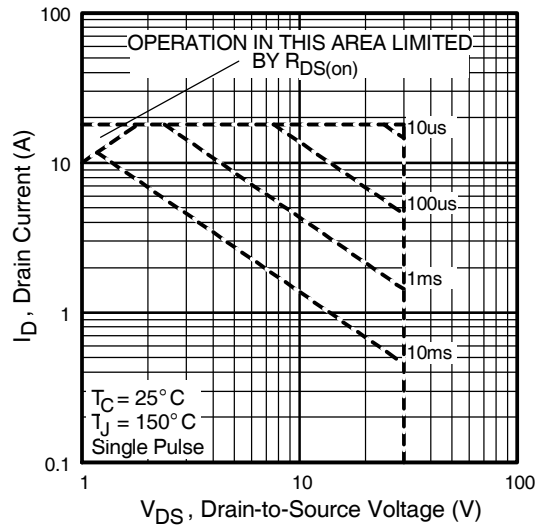
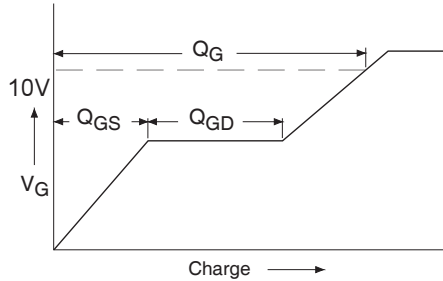
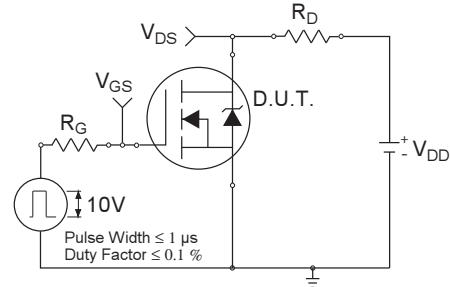
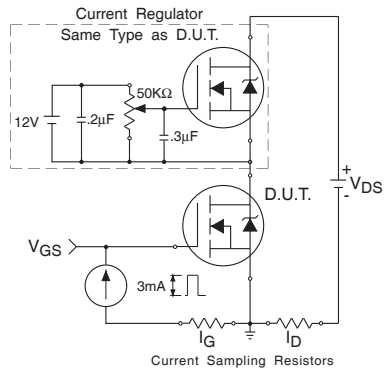
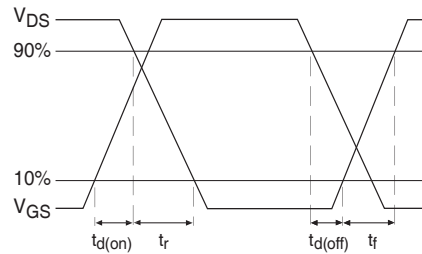
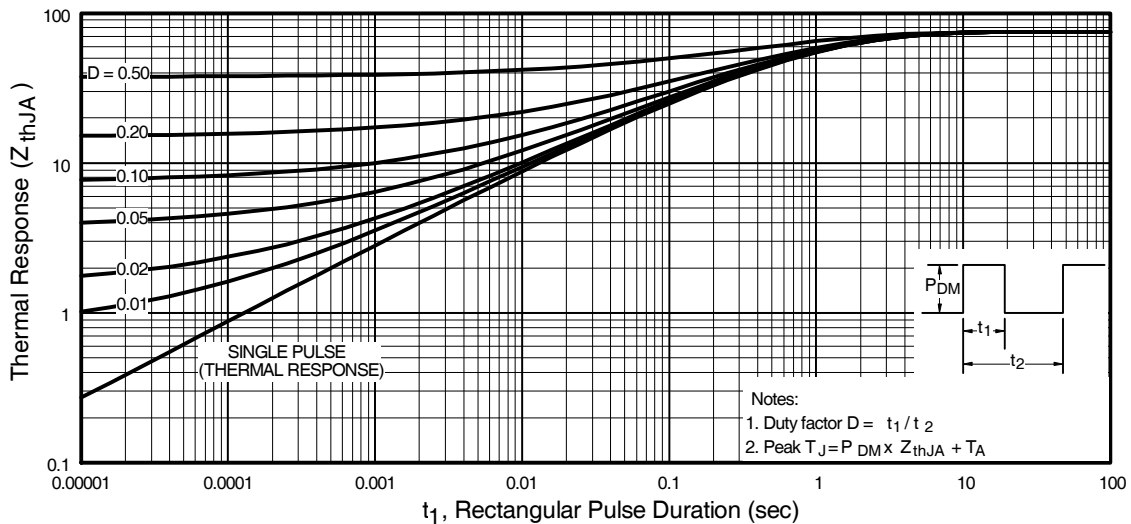
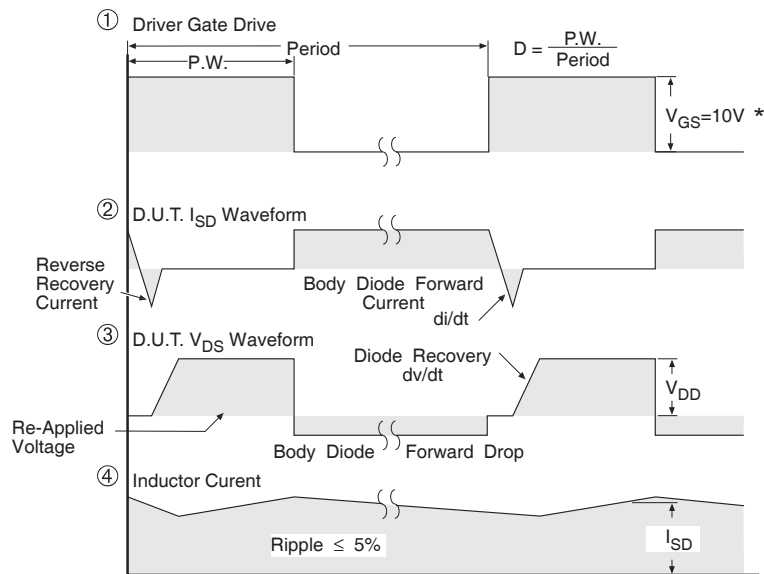
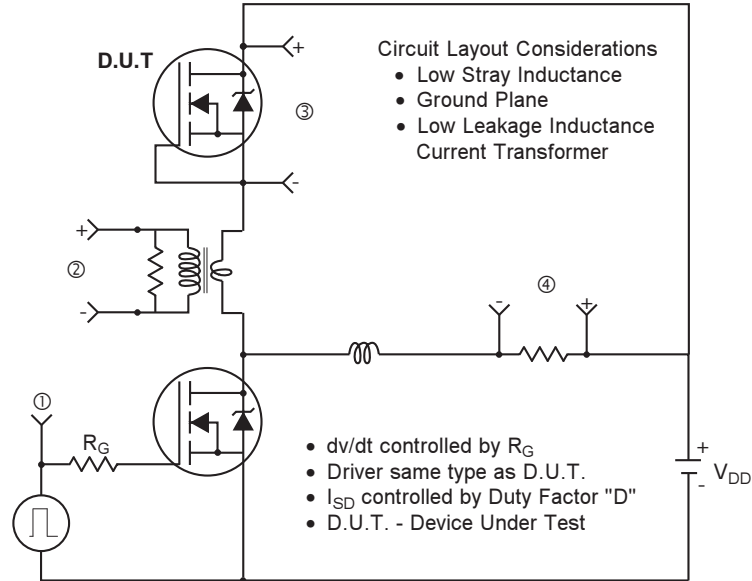

Fig 8. Maximum Safe Operating Area

Fig 9a. Basic Gate Charge Waveform

Fig 10a. Switching Time Test Circuit

Fig 9b. Gate Charge Test Circuit

Fig 10b. Switching Time Waveforms

Fig 11. Maximum Effective Transient Thermal Impedance, Junction-to-Ambient

Peak Diode Recovery dv/dt Test Circuit

* $V_{GS} = 5V$ for Logic Level Devices

Fig 13. For N-channel HEXFET[®] power MOSFET s

Micro6 (SOT23 6L) Package Outline

Dimensions are shown in millimeters (inches)

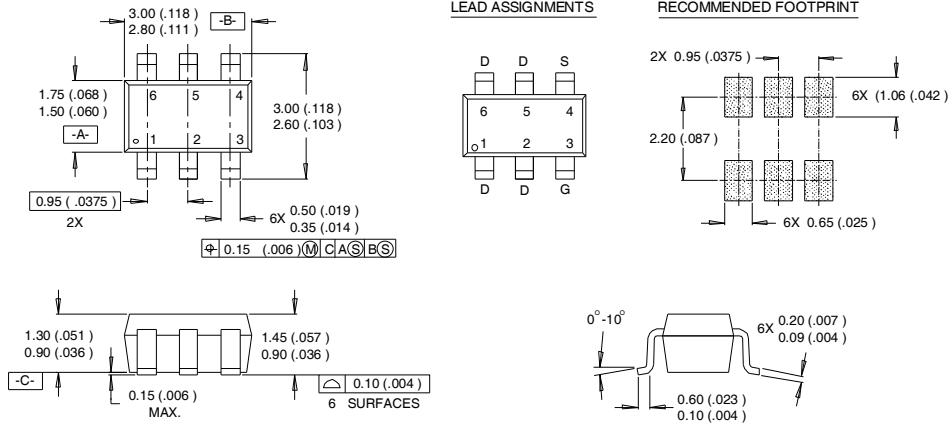

- NOTES :
1. DIMENSIONING & TOLERANCING PER ANSI Y14.5M-1982.
 2. CONTROLLING DIMENSION : MILLIMETER.
 3. DIMENSIONS ARE SHOWN IN MILLIMETERS (INCHES).

Micro6 (SOT23 6L) Part Marking Information

W = (1-26) IF PRECEDED BY LAST DIGIT OF CALENDAR YEAR

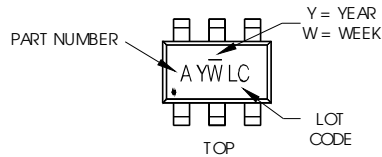

PART NUMBER CODE REFERENCE:

- A = IRLMS1902
- B = IRLMS1503
- C = IRLMS6702
- D = IRLMS5703
- E = IRLMS6802
- F = IRLMS4502
- G = IRLMS2002
- H = IRLMS6803

Note: A line above the work week (as shown here) indicates Lead-Free.

YEAR	Y	WORK WEEK	W
2001	1	01	A
2002	2	02	B
2003	3	03	C
2004	4	04	D
2005	5		
2006	6		
2007	7		
2008	8		
2009	9		
2010	0	24	X
		25	Y
		26	Z

W = (27-52) IF PRECEDED BY A LETTER

YEAR	Y	WORK WEEK	W
2001	A	27	A
2002	B	28	B
2003	C	29	C
2004	D	30	D
2005	E		
2006	F		
2007	G		
2008	H		
2009	J		
2010	K	50	X
		51	Y
		52	Z

Note: For the most current drawing please refer to IR website at <http://www.irf.com/package/>

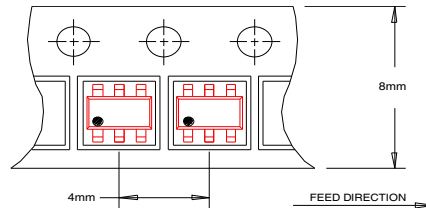
Micro6 Tape & Reel Information (Dimensions are shown in millimeters (inches))

NOTES:
1. OUTLINE CONFORMS TO EIA-481 & EIA-541.

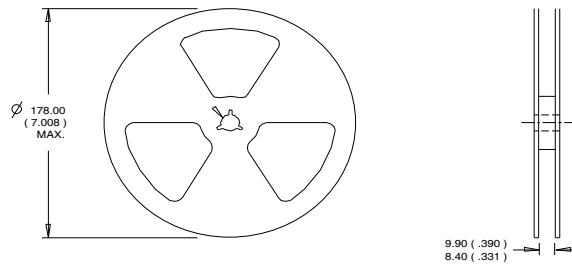

NOTES:
1. CONTROLLING DIMENSION : MILLIMETER.
2. OUTLINE CONFORMS TO EIA-481 & EIA-541.

Note: For the most current drawing please refer to IR website at <http://www.irf.com/package/>

Qualification information[†]

Qualification level	Industrial (per JEDEC JESD47F ^{††} guidelines)	
Moisture Sensitivity Level	Micro6™	MSL1 (per JEDEC J-STD-020D ^{††})
RoHS compliant	Yes	

[†] Qualification standards can be found at International Rectifier's web site: <http://www.irf.com/product-info/reliability>

^{††} Applicable version of JEDEC standard at the time of product release