

MDP13N50B / MDF13N50B

N-Channel MOSFET 500V, 13.0 A, 0.5Ω

General Description

The MDP/F13N50B uses advanced Magnachip's MOSFET Technology, which provides low on-state resistance, high switching performance and excellent quality.

MDP/F13N50B is suitable device for SMPS, HID and general purpose applications.

Features

- $V_{DS} = 500V$
- $I_D = 13.0A$ @ $V_{GS} = 10V$
- $R_{DS(ON)} \leq 0.5\Omega$ @ $V_{GS} = 10V$

Applications

- Power Supply
- PFC
- Ballast

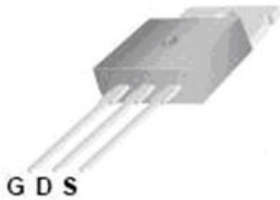

TO-220₄
MDP Series₄



TO-220F₄
MDF Series₄

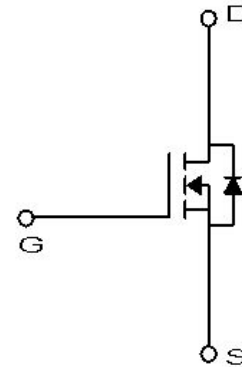

Absolute Maximum Ratings (Ta = 25°C)

Characteristics		Symbol	MDP13N50B	MDF13N50B	Unit
Drain-Source Voltage		V_{DSS}	500		V
Gate-Source Voltage		V_{GSS}	±30		V
Continuous Drain Current	$T_C=25^\circ C$	I_D	13	13*	A
	$T_C=100^\circ C$		8.2	8.2*	A
Pulsed Drain Current ⁽¹⁾		I_{DM}	52	52*	A
Power Dissipation	$T_C=25^\circ C$	P_D	187	41	W
	Derate above 25 °C		1.49	0.33	W/°C
Repetitive Avalanche Energy ⁽¹⁾		E_{AR}	18.7		mJ
Peak Diode Recovery dv/dt ⁽³⁾		dv/dt	4.5		V/ns
Single Pulse Avalanche Energy ⁽⁴⁾		E_{AS}	580		mJ
Junction and Storage Temperature Range		T_J, T_{stg}	-55~150		°C

* Id limited by maximum junction temperature

Thermal Characteristics

Characteristics	Symbol	MDP13N50B	MDF13N50B	Unit
Thermal Resistance, Junction-to-Ambient ⁽¹⁾	$R_{\theta JA}$	62.5	62.5	°C/W
Thermal Resistance, Junction-to-Case ⁽¹⁾	$R_{\theta JC}$	0.67	3.05	

Ordering Information

Part Number	Temp. Range	Package	Packing	RoHS Status
MDP13N50BTH	-55~150°C	TO-220	Tube	Halogen Free
MDF13N50BTH	-55~150°C	TO-220F	Tube	Halogen Free

Electrical Characteristics (Ta = 25°C)

Characteristics	Symbol	Test Condition	Min	Typ	Max	Unit
Static Characteristics						
Drain-Source Breakdown Voltage	BV_{DSS}	$I_D = 250\mu A, V_{GS} = 0V$	500	-	-	V
Gate Threshold Voltage	$V_{GS(th)}$	$V_{DS} = V_{GS}, I_D = 250\mu A$	2.0	-	4.0	
Drain Cut-Off Current	I_{DSS}	$V_{DS} = 500V, V_{GS} = 0V$	-	-	1	μA
Gate Leakage Current	I_{GSS}	$V_{GS} = \pm 30V, V_{DS} = 0V$	-	-	100	nA
Drain-Source ON Resistance	$R_{DS(on)}$	$V_{GS} = 10V, I_D = 6.5A$	-	0.39	0.5	Ω
Forward Transconductance	g_{fs}	$V_{DS} = 40V, I_D = 6.5A$	-	13	-	S
Dynamic Characteristics						
Total Gate Charge	Q_g	$V_{DS} = 400V, I_D = 13.0A, V_{GS} = 10V^{(3)}$	-	27	-	nC
Gate-Source Charge	Q_{gs}		-	6.3	-	
Gate-Drain Charge	Q_{gd}		-	8.6	-	
Input Capacitance	C_{iss}	$V_{DS} = 25V, V_{GS} = 0V, f = 1.0MHz$	-	1459	-	pF
Reverse Transfer Capacitance	C_{rss}		-	7.4	-	
Output Capacitance	C_{oss}		-	174	-	
Turn-On Delay Time	$t_{d(on)}$	$V_{GS} = 10V, V_{DS} = 250V, I_D = 13.0A, R_G = 25\Omega^{(3)}$	-	21	-	ns
Rise Time	t_r		-	47	-	
Turn-Off Delay Time	$t_{d(off)}$		-	131	-	
Fall Time	t_f		-	54	-	
Drain-Source Body Diode Characteristics						
Maximum Continuous Drain to Source Diode Forward Current	I_S		-	13	-	A
Source-Drain Diode Forward Voltage	V_{SD}	$I_S = 13.0A, V_{GS} = 0V$	-	-	1.4	V
Body Diode Reverse Recovery Time	t_{rr}	$I_F = 13.0A, di/dt = 100A/\mu s^{(3)}$	-	325	-	ns
Body Diode Reverse Recovery Charge	Q_{rr}		-	2.9	-	μC

Note :

- Pulse width is based on $R_{\theta JC}$ & $R_{\theta JA}$ and the maximum allowed junction temperature of 150°C.
- Pulse test: pulse width $\leq 300\mu s$, duty cycle $\leq 2\%$, pulse width limited by junction temperature $T_{J(MAX)} = 150^\circ C$.
- $I_{SD} \leq 13.0A$, $di/dt \leq 200A/\mu s$, $V_{DD} \leq BV_{DSS}$, $R_G = 25\Omega$, Starting $T_J = 25^\circ C$
- $L = 6.2mH$, $I_{AS} = 13.0A$, $V_{DD} = 50V$, $R_G = 25\Omega$, Starting $T_J = 25^\circ C$

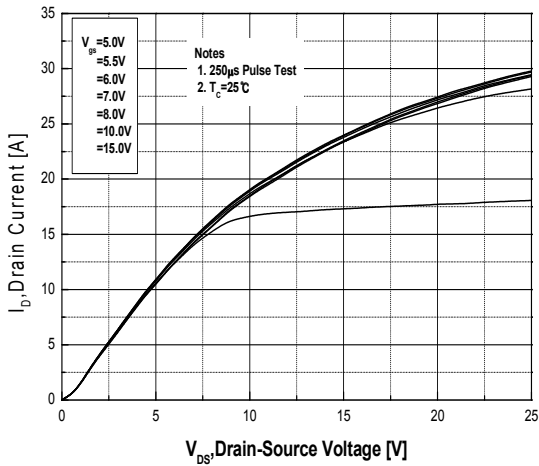

Fig.1 On-Region Characteristics

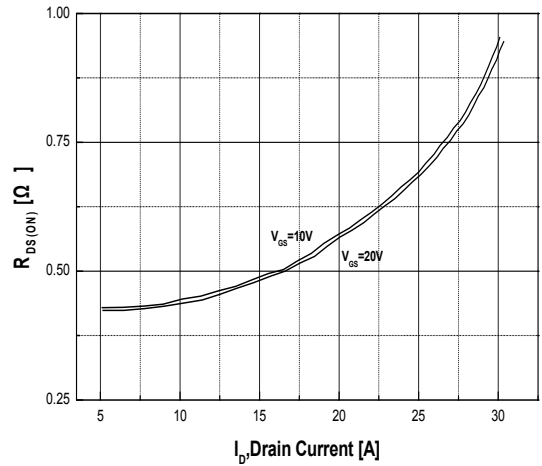

Fig.2 On-Resistance Variation with Drain Current and Gate Voltage

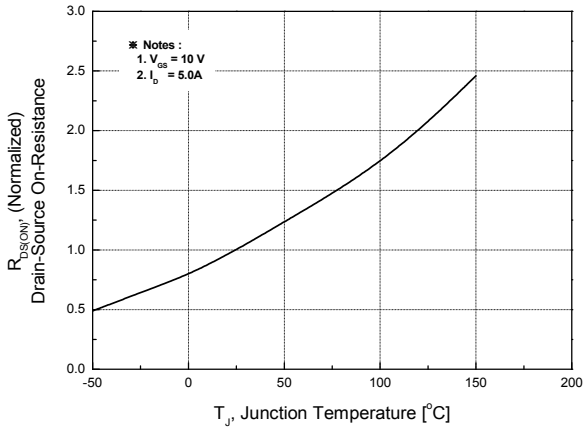

Fig.3 On-Resistance Variation with Temperature

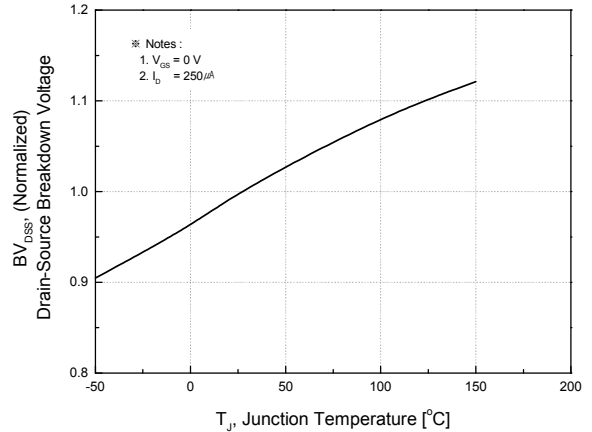

Fig.4 Breakdown Voltage Variation vs. Temperature

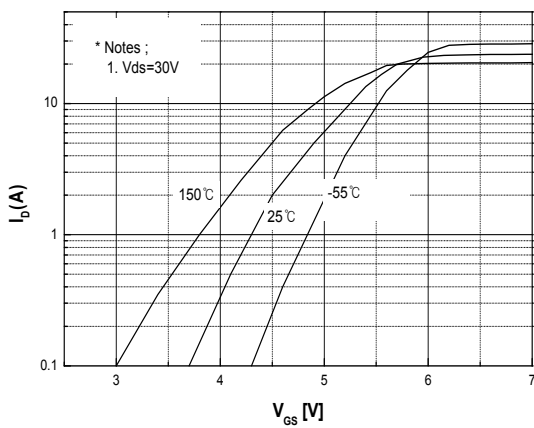

Fig.5 Transfer Characteristics

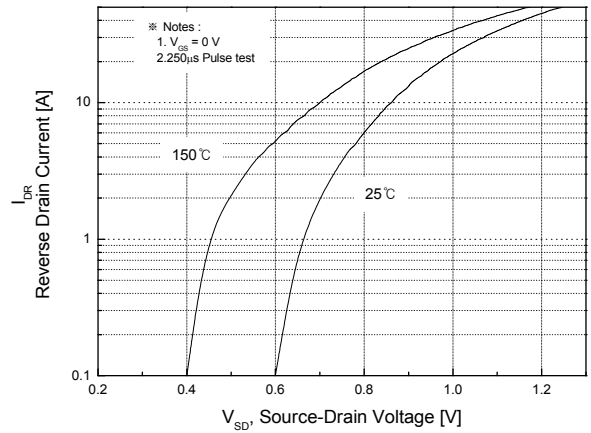

Fig.6 Body Diode Forward Voltage Variation with Source Current and Temperature

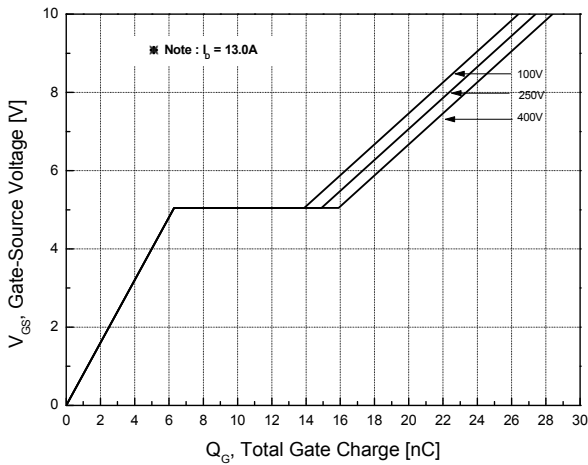

Fig.7 Gate Charge Characteristics

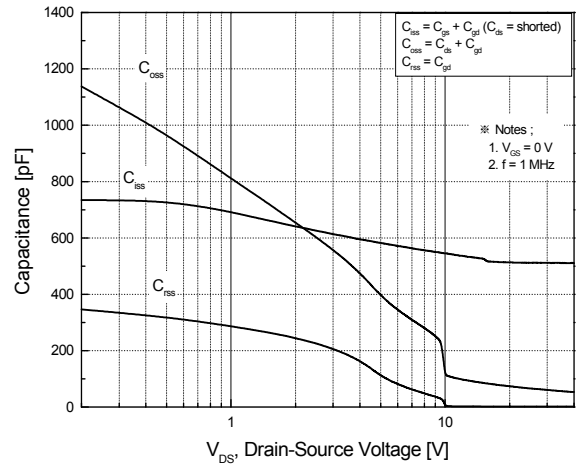

Fig.8 Capacitance Characteristics

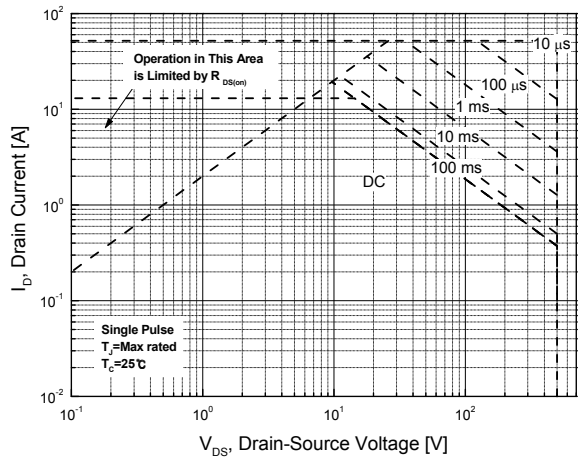

Fig.9 Maximum Safe Operating Area MDP13N50B (TO-220)

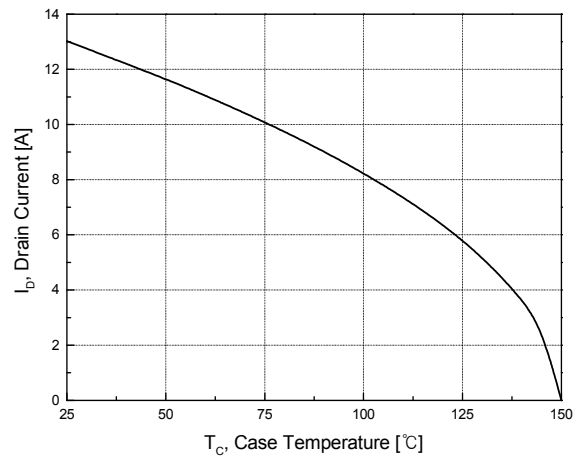

Fig.10 Maximum Drain Current vs. Case Temperature

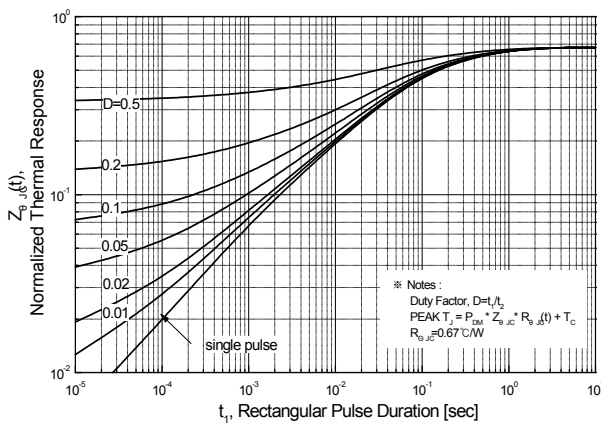

Fig.11 Transient Thermal Response Curve MDP13N50B (TO-220)

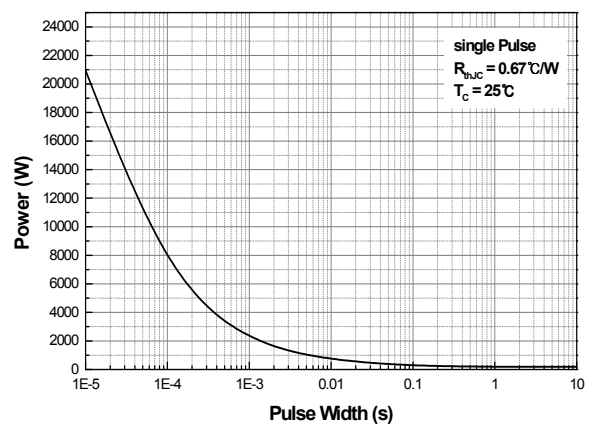
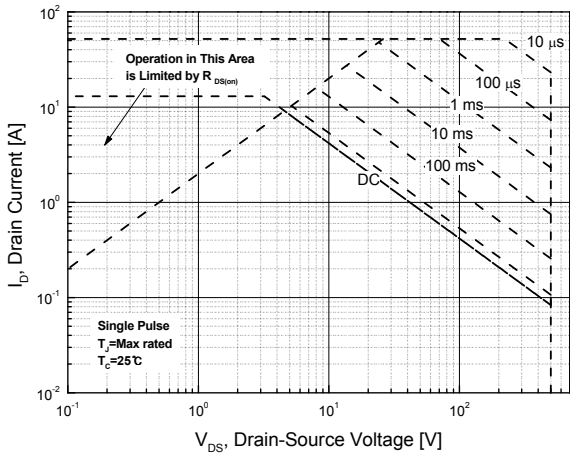
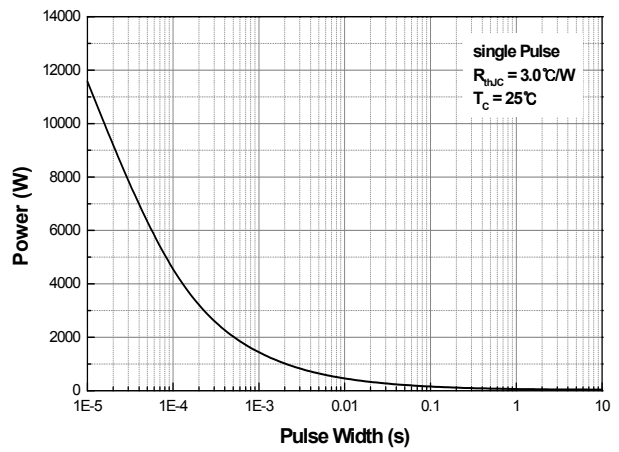

Fig.12 Single Pulse Maximum Power Dissipation – MDP13N50B (TO-220)



**Fig.13 Maximum Safe Operating Area
MDF13N50B (TO-220F)**



**Fig.14 Single Pulse Maximum Power
Dissipation – MDF13N50B (TO-220F)**

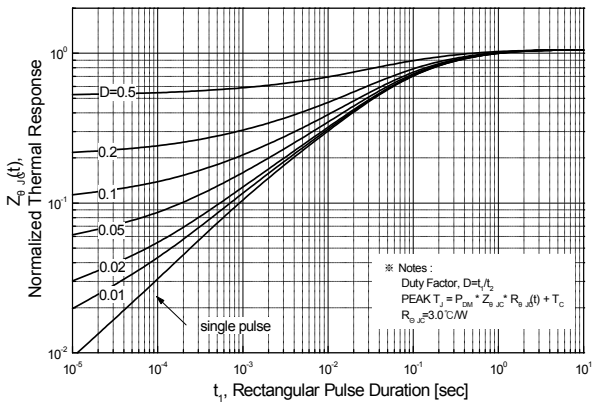
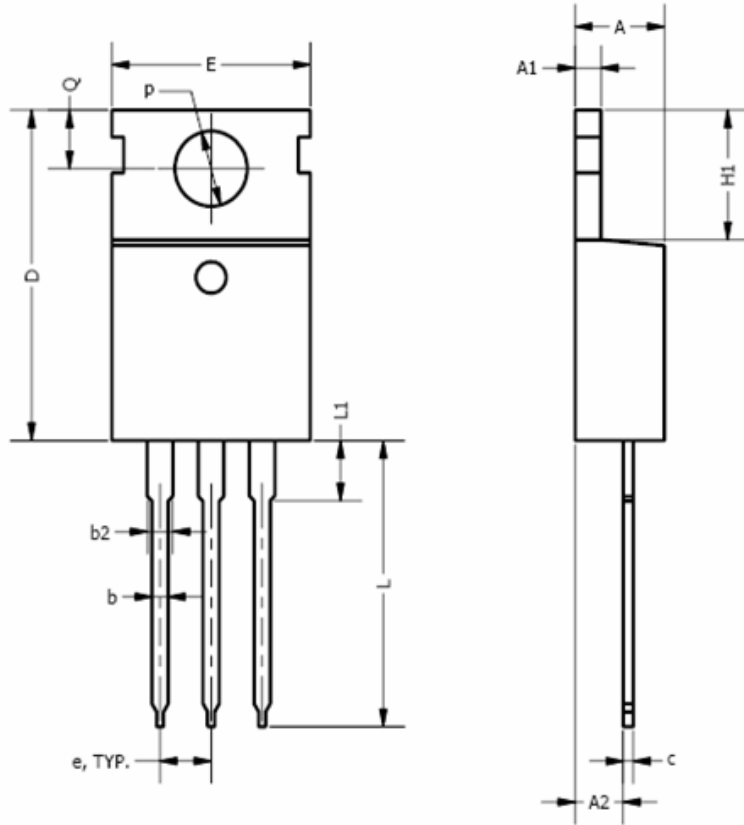

**Fig.15 Transient Thermal Response Curve
MDF13N50B (TO-220F)**

Physical Dimensions

3 Leads, TO-220

Dimensions are in millimeters unless otherwise specified



Symbol	Min	Nom	Max
A	3.56		4.83
A1	0.50		1.40
A2	2.03		2.92
b	0.38	0.69	1.02
b2	1.14	1.45	1.78
c	0.36		0.61
D	14.22		16.51
e	2.54 TYP		
E	9.65		10.67
H1	5.84		6.86
L	12.70		14.73
L1			6.35
ϕP	3.53		4.09
Q	2.54		3.43

Physical Dimension

3 Leads, TO-220F

Dimensions are in millimeters unless otherwise specified

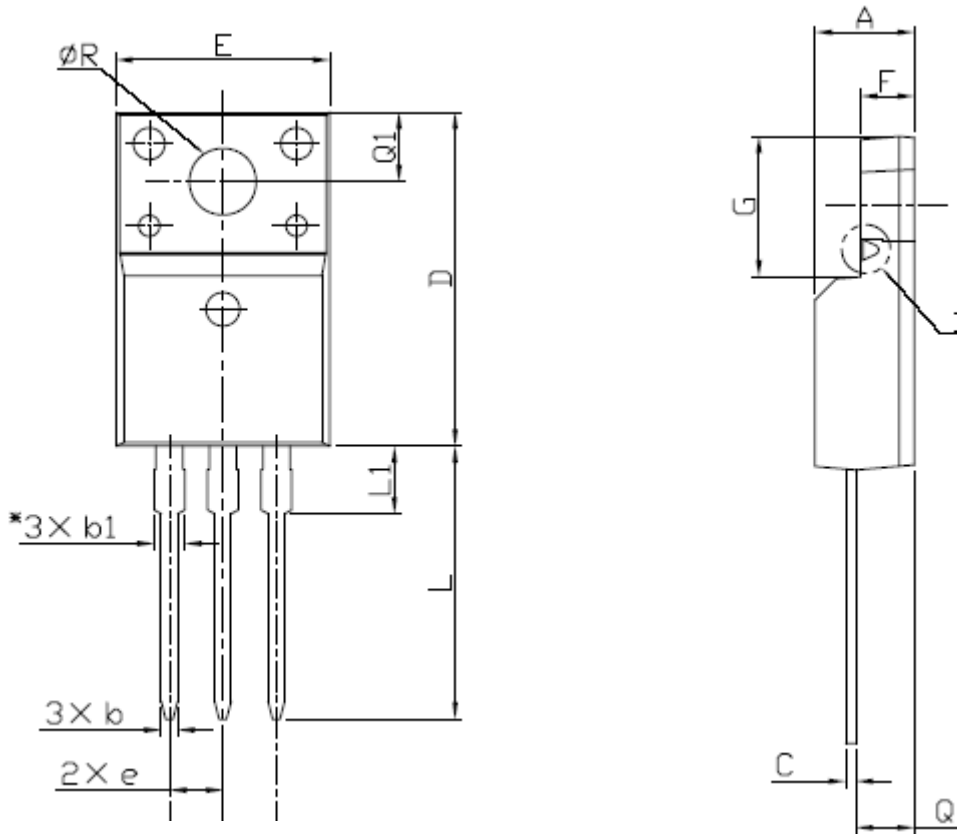

Symbol	Min	Nom	Max
A	4.50		4.93
b	0.63		0.91
b1	1.15		1.47
C	0.33		0.63
D	15.47		16.13
E	9.60		10.71
e		2.54	
F	2.34		2.84
G	6.48		6.90
L	12.24		13.72
L1	2.79		3.67
Q	2.52		2.96
Q1	3.10		3.50
ϕR	3.00		3.55

Worldwide Sales Support Locations**U.S.A****Sunnyvale Office**

787 N. Mary Ave. Sunnyvale
CA 94085 U.S.A
Tel : 1-408-636-5200
Fax : 1-408-213-2450
E-Mail : usasales@magnachip.com

U.K

Knyvett House The Causeway,
Staines Middx, TW18 3BA,U.K.
Tel : +44 (0) 1784-895-000
Fax : +44 (0) 1784-895-115
E-Mail : uksales@magnachip.com

Japan**Osaka Office**

3F, Shin-Osaka MT-2 Bldg 3-5-36
Miyahara Yodogawa-Ku
Osaka, 532-0003 Japan
Tel : 81-6-6394-9160
Fax : 81-6-6394-9150
E-Mail : osakasales@magnachip.com

Taiwan R.O.C

2F, No.61, Chowize Street, Nei Hu
Taipei, 114 Taiwan R.O.C
Tel : 886-2-2657-7898
Fax : 886-2-2657-8751
E-Mail : taiwansales@magnachip.com

China**Hong Kong Office**

Suite 1024, Ocean Centre 5 Canton Road,
Tsim Sha Tsui Kowloon, Hong Kong
Tel : 852-2828-9700
Fax : 852-2802-8183
E-Mail : chinasales@magnachip.com

Shenzhen Office

Room 2003B, 20/F
International Chamber of Commerce Tower
Fuhua Road3 CBD, Futian District, China
Tel : 86-755-8831-5561
Fax : 86-755-8831-5565
E-Mail : chinasales@magnachip.com

Shanghai Office

Room E, 8/F, Liaoshen International Building 1068
Wuzhong Road, (C) 201103
Shanghai, China
Tel : 86-21-6405-1521
Fax : 86-21-6505-1523
E-Mail : chinasales@magnachip.com

Korea

891, Daechi-Dong, Kangnam-Gu
Seoul, 135-738 Korea
Tel : 82-2-6903-3451
Fax : 82-2-6903-3668 ~9
Email : koreasales@magnachip.com

DISCLAIMER:

The Products are not designed for use in hostile environments, including, without limitation, aircraft, nuclear power generation, medical appliances, and devices or systems in which malfunction of any Product can reasonably be expected to result in a personal injury. Seller's customers using or selling Seller's products for use in such applications do so at their own risk and agree to fully defend and indemnify Seller.

MagnaChip reserves the right to change the specifications and circuitry without notice at any time. MagnaChip does not consider responsibility for use of any circuitry other than circuitry entirely included in a MagnaChip product. **MagnaChip** is a registered trademark of MagnaChip Semiconductor Ltd.