

**RADIATION HARDENED
 POWER MOSFET
 THRU-HOLE (TO-204)**

**IRH7150
 100V, N-CHANNEL
 RAD Hard™ HEXFET® TECHNOLOGY**

Product Summary

Part Number	Radiation Level	RDS(on)	Id
IRH7150	100K Rads (Si)	0.065Ω	34A
IRH3150	300K Rads (Si)	0.065Ω	34A
IRH4150	600K Rads (Si)	0.065Ω	34A
IRH8150	1000K Rads (Si)	0.065Ω	34A



TO-204AE

International Rectifier's RADHard HEXFET® technology provides high performance power MOSFETs for space applications. This technology has over a decade of proven performance and reliability in satellite applications. These devices have been characterized for both Total Dose and Single Event Effects (SEE). The combination of low Rds(on) and low gate charge reduces the power losses in switching applications such as DC to DC converters and motor control. These devices retain all of the well established advantages of MOSFETs such as voltage control, fast switching, ease of paralleling and temperature stability of electrical parameters.

Features:

- Single Event Effect (SEE) Hardened
- Low RDS(on)
- Low Total Gate Charge
- Proton Tolerant
- Simple Drive Requirements
- Ease of Paralleling
- Hermetically Sealed
- Ceramic Package
- Light Weight

Absolute Maximum Ratings

Pre-Irradiation

	Parameter		Units
Id @ VGS = 12V, TC = 25°C	Continuous Drain Current	34	A
Id @ VGS = 12V, TC = 100°C	Continuous Drain Current	21	
IdM	Pulsed Drain Current ①	136	
PD @ TC = 25°C	Max. Power Dissipation	150	W
	Linear Derating Factor	1.2	W/°C
VGS	Gate-to-Source Voltage	±20	V
EAS	Single Pulse Avalanche Energy ②	500	mJ
IAR	Avalanche Current ①	34	A
EAR	Repetitive Avalanche Energy ①	15	mJ
dv/dt	Peak Diode Recovery dv/dt ③	5.5	V/ns
TJ	Operating Junction	-55 to 150	°C
TSTG	Storage Temperature Range		
	Lead Temperature	300 (0.063 in.(1.6mm) from case for 10s)	
	Weight	11.5 (Typical)	g

For footnotes refer to the last page

Electrical Characteristics @ T_j = 25°C (Unless Otherwise Specified)

	Parameter	Min	Typ	Max	Units	Test Conditions
BV _{DSS}	Drain-to-Source Breakdown Voltage	100	—	—	V	V _{GS} = 0V, I _D = 1.0mA
ΔBV _{DSS} /ΔT _J	Temperature Coefficient of Breakdown Voltage	—	0.13	—	V/°C	Reference to 25°C, I _D = 1.0mA
R _{DS(on)}	Static Drain-to-Source On-State Resistance	—	—	0.065	Ω	V _{GS} = 12V, I _D = 21A ④
		—	—	0.076		V _{GS} = 12V, I _D = 34A
V _{GS(th)}	Gate Threshold Voltage	2.0	—	4.0	V	V _{DS} = V _{GS} , I _D = 1.0mA
g _{fs}	Forward Transconductance	8.0	—	—	S (ℓ)	V _{DS} > 15V, I _{DS} = 21A ④
I _{DSS}	Zero Gate Voltage Drain Current	—	—	25	μA	V _{DS} = 80V, V _{GS} = 0V
		—	—	250		V _{DS} = 80V, V _{GS} = 0V, T _J = 125°C
I _{GSS}	Gate-to-Source Leakage Forward	—	—	100	nA	V _{GS} = 20V
I _{GSS}	Gate-to-Source Leakage Reverse	—	—	-100		V _{GS} = -20V
Q _g	Total Gate Charge	—	—	160	nC	V _{GS} = 12V, I _D = 34A
Q _{gs}	Gate-to-Source Charge	—	—	35		V _{DS} = 50V
Q _{gd}	Gate-to-Drain ('Miller') Charge	—	—	65		
t _{d(on)}	Turn-On Delay Time	—	—	45	ns	V _{DD} = 50V, I _D = 34A V _{GS} = 12V, R _G = 2.35Ω
t _r	Rise Time	—	—	190		
t _{d(off)}	Turn-Off Delay Time	—	—	170		
t _f	Fall Time	—	—	130		
L _S + L _D	Total Inductance	—	10	—	nH	Measured from Drain lead (6mm /0.25in. from package) to Source lead (6mm /0.25in. from package) with Source wires internally bonded from Source Pin to Drain Pad
C _{iss}	Input Capacitance	—	4300	—	pF	V _{GS} = 0V, V _{DS} = -25V f = 1.0MHz
C _{OSS}	Output Capacitance	—	1200	—		
C _{rSS}	Reverse Transfer Capacitance	—	200	—		

Source-Drain Diode Ratings and Characteristics

	Parameter	Min	Typ	Max	Units	Test Conditions
I _S	Continuous Source Current (Body Diode)	—	—	34	A	
I _{SM}	Pulse Source Current (Body Diode) ①	—	—	136		
V _{SD}	Diode Forward Voltage	—	—	1.4	V	T _j = 25°C, I _S = 34A, V _{GS} = 0V ④
t _{rr}	Reverse Recovery Time	—	—	570	nS	T _j = 25°C, I _F = 34A, di/dt ≥ 100A/μs
Q _{RR}	Reverse Recovery Charge	—	—	5.8	μC	V _{DD} ≤ 25V ④
t _{on}	Forward Turn-On Time	Intrinsic turn-on time is negligible. Turn-on speed is substantially controlled by L _S + L _D .				

Thermal Resistance

	Parameter	Min	Typ	Max	Units	Test Conditions
R _{thJC}	Junction-to-Case	—	—	0.83	°C/W	Typical socket mount
R _{thJA}	Junction-to-Ambient	—	—	30		
R _{thCS}	Case-to-Sink	—	0.12	—		

Note: Corresponding Spice and Saber models are available on the G&S Website.

For footnotes refer to the last page

Radiation Characteristics

IRH7150

International Rectifier Radiation Hardened MOSFETs are tested to verify their radiation hardness capability. The hardness assurance program at International Rectifier is comprised of two radiation environments. Every manufacturing lot is tested for total ionizing dose (per notes 5 and 6) using the TO-3 package. Both pre- and post-irradiation performance are tested and specified using the same drive circuitry and test conditions in order to provide a direct comparison.

Table 1. Electrical Characteristics @ Tj = 25°C, Post Total Dose Irradiation ⑤⑥

	Parameter	100K Rads(Si) ¹		600 to 1000K Rads (Si) ²		Units	Test Conditions
		Min	Max	Min	Max		
BV _{DSS}	Drain-to-Source Breakdown Voltage	200	—	200	—	V	V _{GS} = 0V, I _D = 1.0mA
V _{GS(th)}	Gate Threshold Voltage	2.0	4.0	1.25	4.5		V _{GS} = V _{DS} , I _D = 1.0mA
I _{GSS}	Gate-to-Source Leakage Forward	—	100	—	100	nA	V _{GS} = 20V
I _{GSS}	Gate-to-Source Leakage Reverse	—	-100	—	-100		V _{GS} = -20 V
I _{DSS}	Zero Gate Voltage Drain Current	—	25	—	50	μA	V _{DS} =80V, V _{GS} =0V
R _{DS(on)}	Static Drain-to-Source ④ On-State Resistance (TO-3)	—	0.065	—	0.09	Ω	V _{GS} = 12V, I _D =21A
R _{DS(on)}	Static Drain-to-Source ④ On-State Resistance (TO-204AA)	—	0.065	—	0.09	Ω	V _{GS} = 12V, I _D =21A
V _{SD}	Diode Forward Voltage ④	—	1.4	—	1.4	V	V _{GS} = 0V, I _S = 34A

1. Part number IRH7150

2. Part numbers IRH3150, IRH4150 and IRH8150

International Rectifier radiation hardened MOSFETs have been characterized in heavy ion environment for Single Event Effects (SEE). Single Event Effects characterization is illustrated in Fig. a and Table 2.

Table 2. Single Event Effect Safe Operating Area

Ion	LET MeV/(mg/cm ²)	Energy (MeV)	Range (μm)	V _{DS} (V)				
				@V _{GS} =0V	@V _{GS} =-5V	@V _{GS} =-10V	@V _{GS} =-15V	@V _{GS} =-20V
Cu	28	285	43	100	100	100	80	60
Br	36.8	305	39	100	90	70	50	—

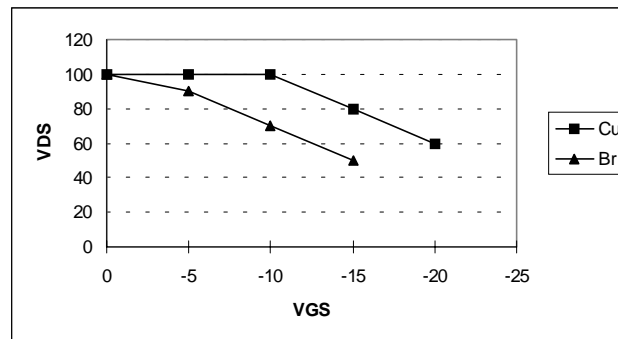

Fig a. Single Event Effect, Safe Operating Area

For footnotes refer to the last page

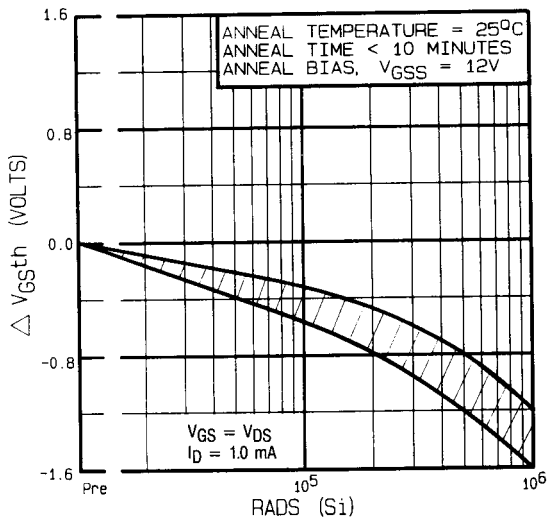

Fig 1. Typical Response of Gate Threshold Voltage Vs. Total Dose Exposure

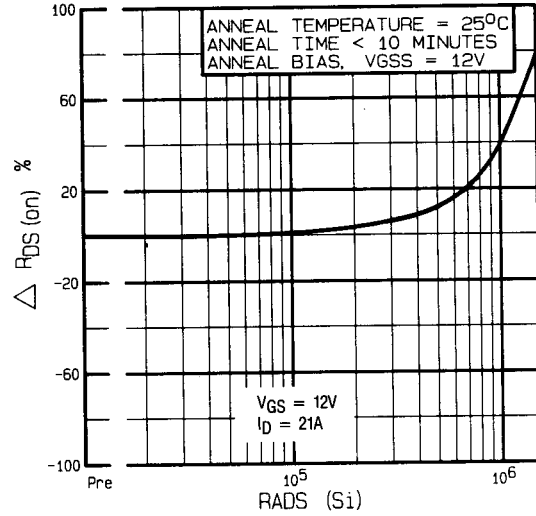

Fig 2. Typical Response of On-State Resistance Vs. Total Dose Exposure

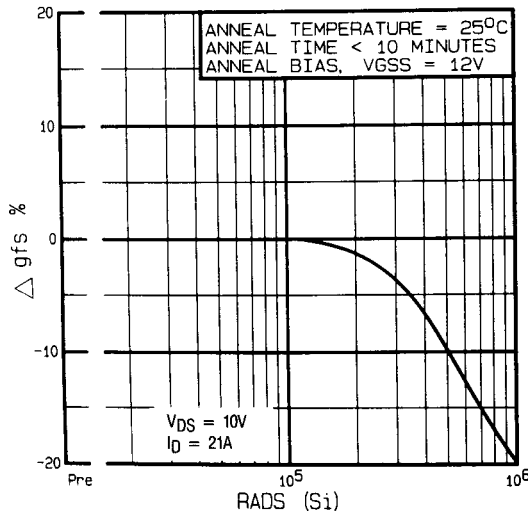

Fig 3. Typical Response of Transconductance Vs. Total Dose Exposure

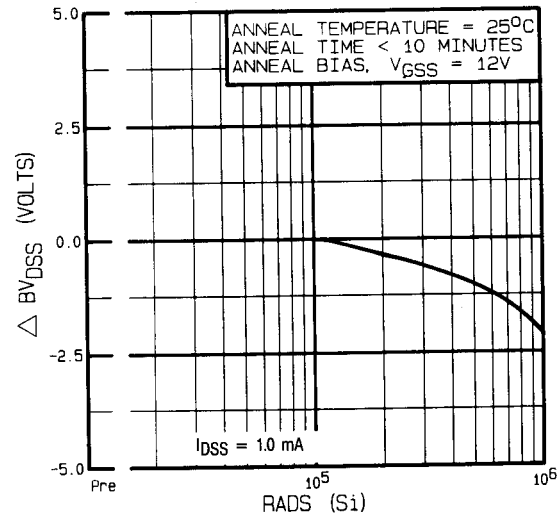

Fig 4. Typical Response of Drain to Source Breakdown Vs. Total Dose Exposure

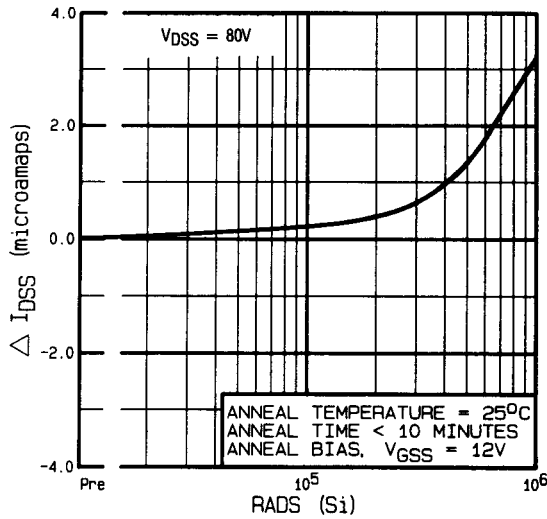

Fig 5. Typical Zero Gate Voltage Drain Current Vs. Total Dose Exposure

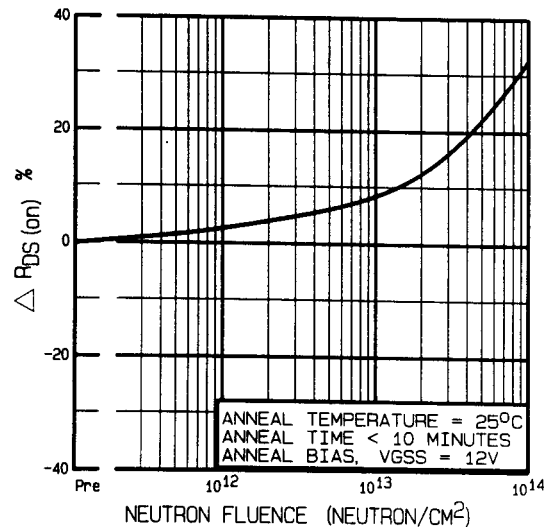

Fig 6. Typical On-State Resistance Vs. Neutron Fluence Level

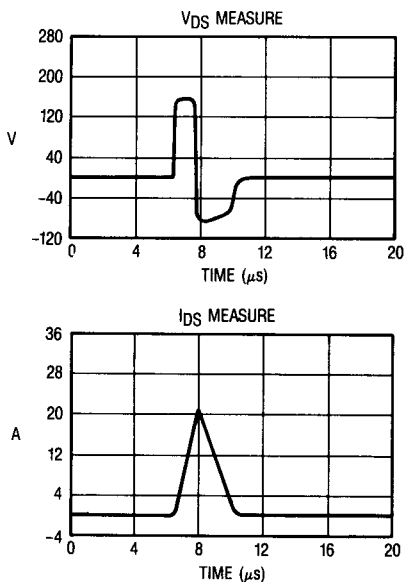

Fig 7. Typical Transient Response of Rad Hard HEXFET During 1×10^{12} Rad (Si)/Sec Exposure

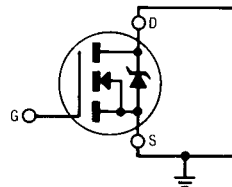

Fig 8a. Gate Stress of V_{GSS} Equals 12 Volts During Radiation

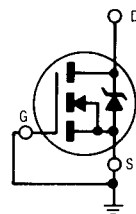

Fig 8b. V_{DSS} Stress Equals 80% of $B_{V_{DSS}}$ During Radiation

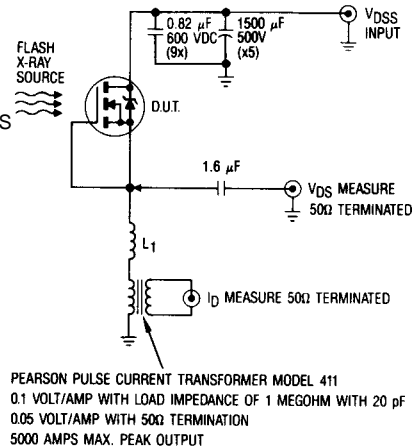

Fig 9. High Dose Rate (Gamma Dot) Test Circuit

Note: Bias Conditions during radiation: $V_{GS} = 12\text{ Vdc}$, $V_{DS} = 0\text{ Vdc}$

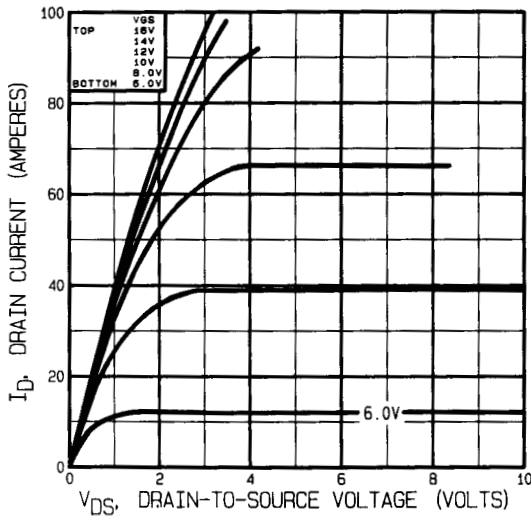

Fig 10. Typical Output Characteristics Pre-Irradiation

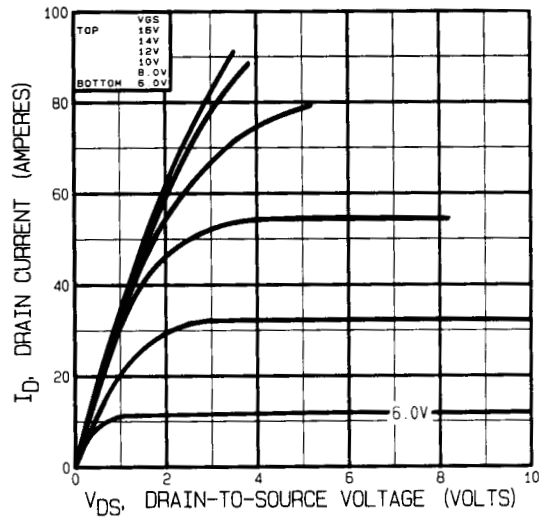

Fig 11. Typical Output Characteristics Post-Irradiation 100K Rads (Si)

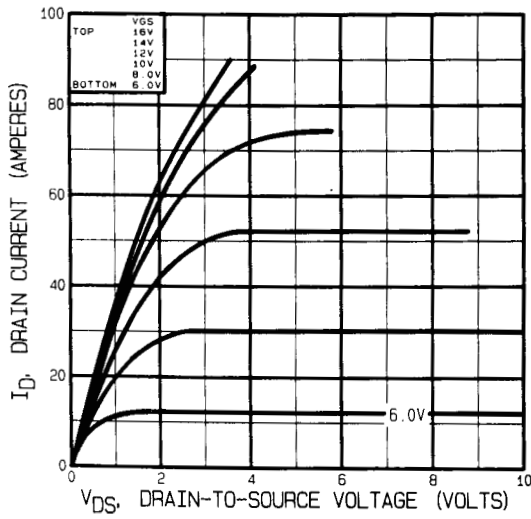

Fig 12. Typical Output Characteristics Post-Irradiation 300K Rads (Si)

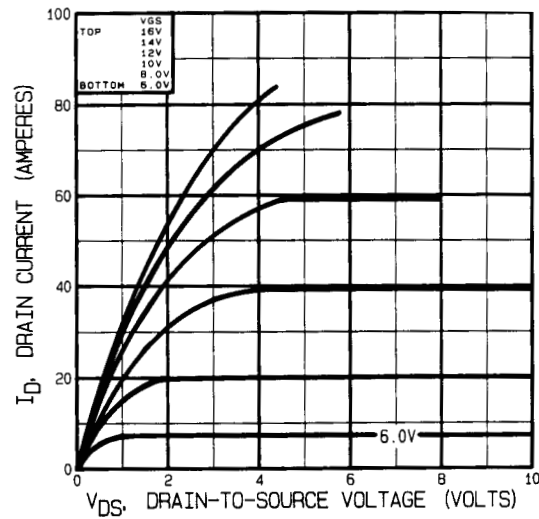

Fig 13. Typical Output Characteristics Post-Irradiation 1 Mega Rads (Si)

Note: Bias Conditions during radiation: $V_{GS} = 0$ Vdc, $V_{DS} = 160$ Vdc

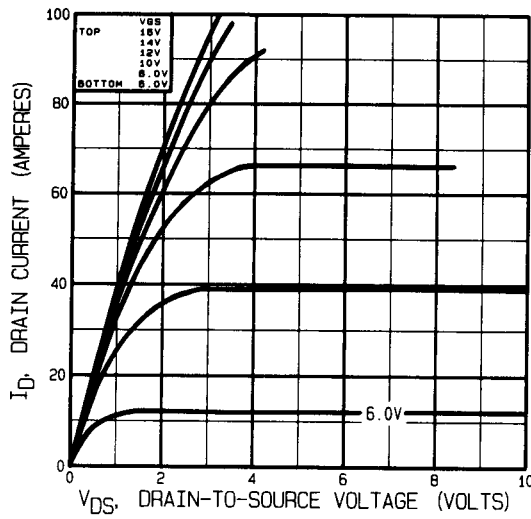

Fig 14. Typical Output Characteristics Pre-Irradiation

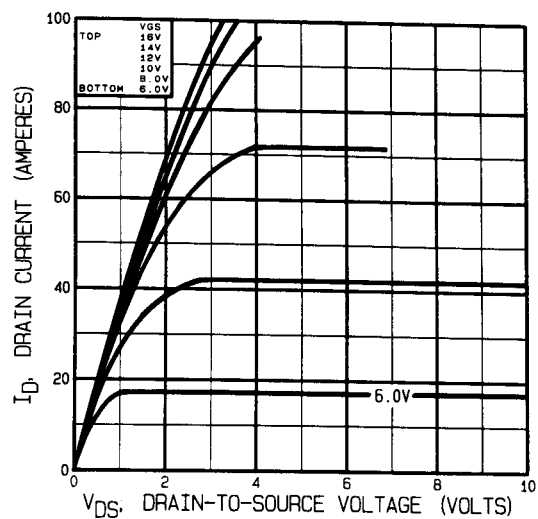

Fig 15. Typical Output Characteristics Post-Irradiation 100K Rads (Si)

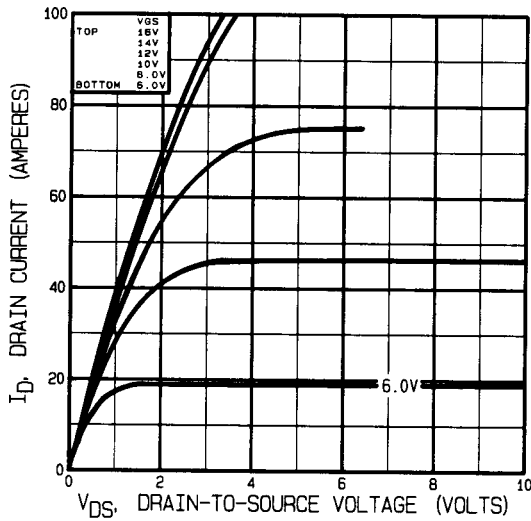

Fig 16. Typical Output Characteristics Post-Irradiation 300K Rads (Si)

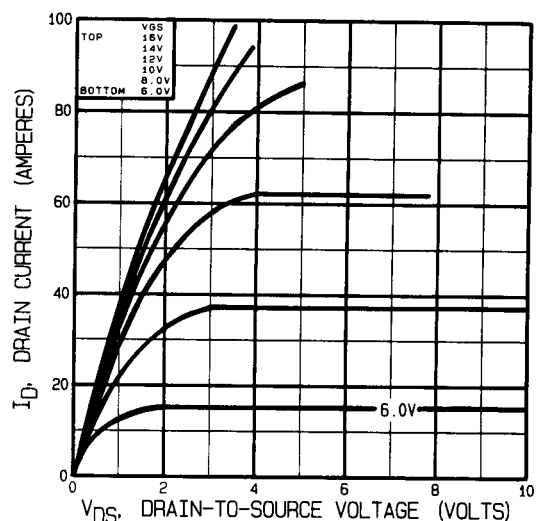

Fig 17. Typical Output Characteristics Post-Irradiation 1 Mega Rads (Si)

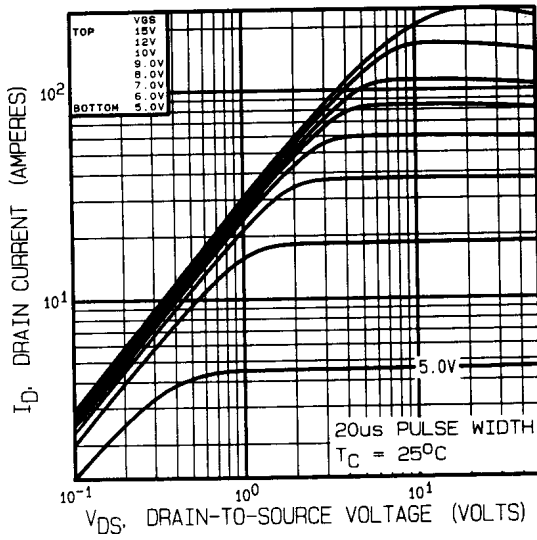

Fig 18. Typical Output Characteristics

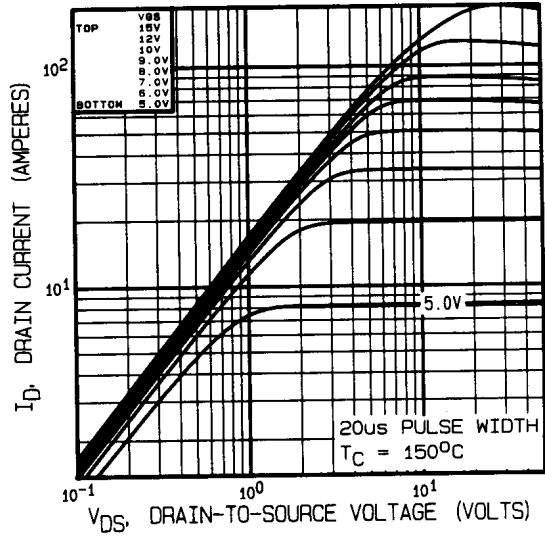

Fig 19. Typical Output Characteristics

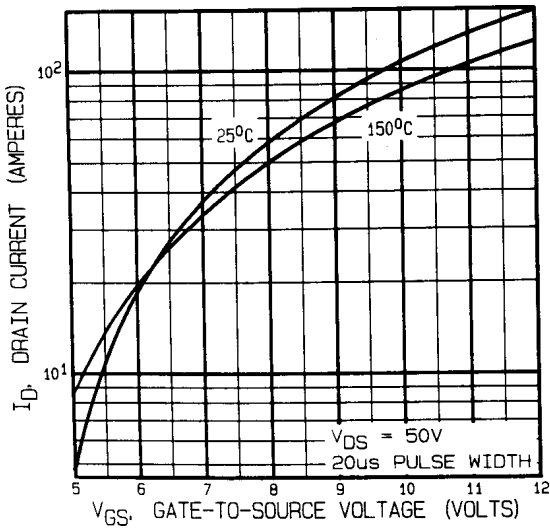

Fig 20. Typical Transfer Characteristics

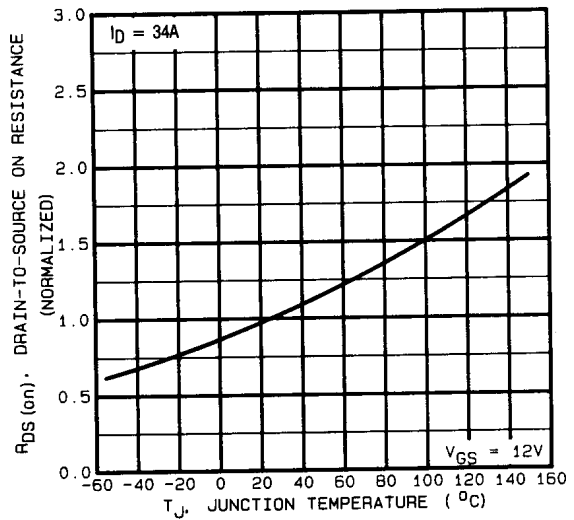

Fig 21. Normalized On-Resistance Vs. Temperature

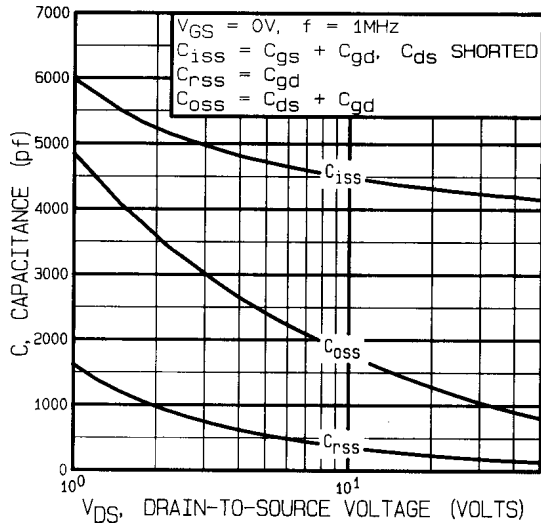

Fig 22. Typical Capacitance Vs. Drain-to-Source Voltage

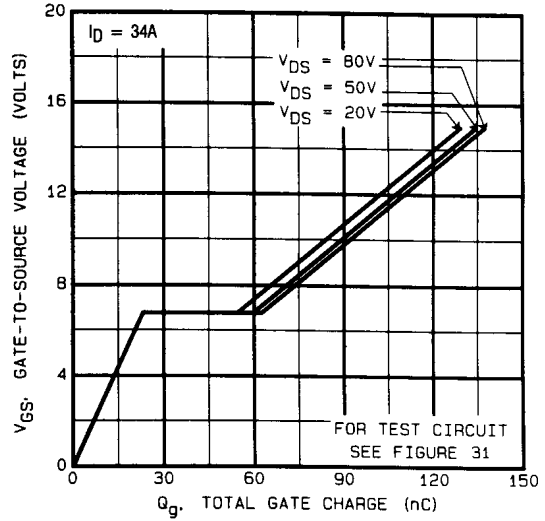

Fig 23. Typical Gate Charge Vs. Gate-to-Source Voltage

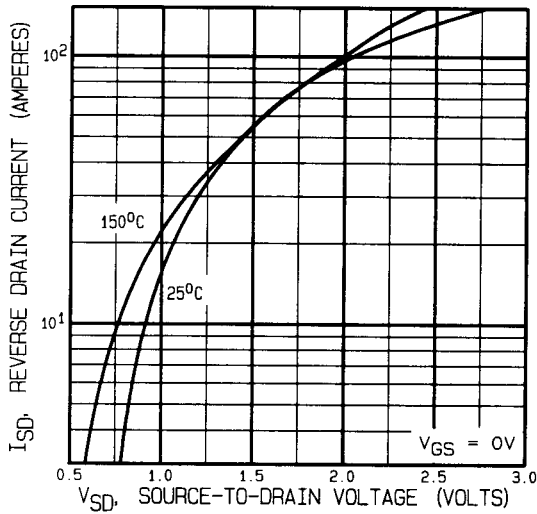

Fig 24. Typical Source-Drain Diode Forward Voltage

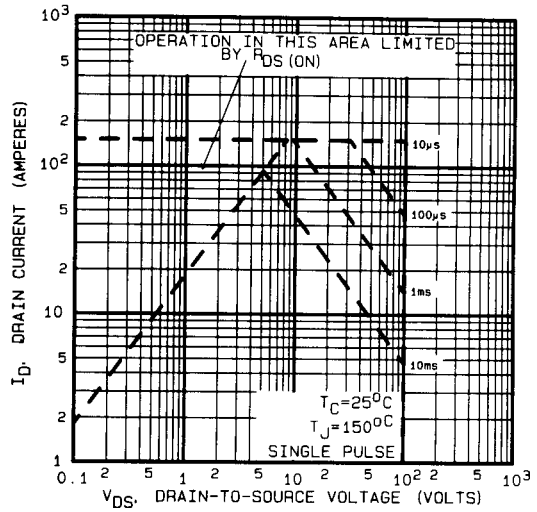

Fig 25. Maximum Safe Operating Area

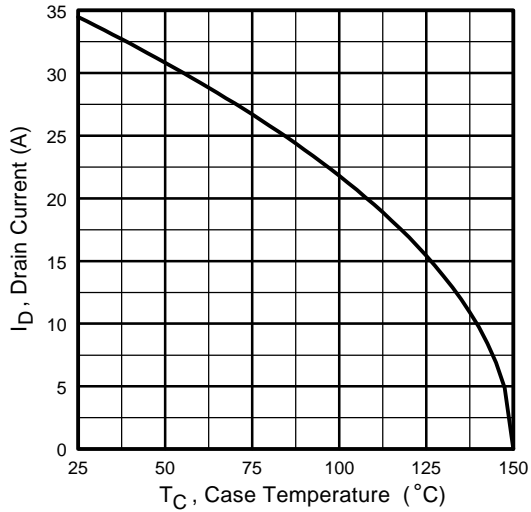

Fig 26. Maximum Drain Current Vs. Case Temperature

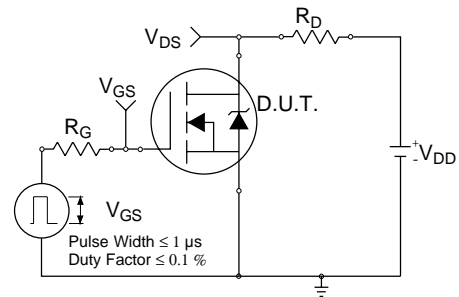

Fig 27a. Switching Time Test Circuit

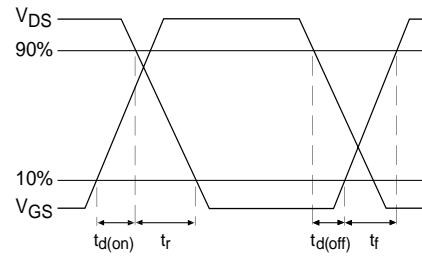

Fig 27b. Switching Time Waveforms

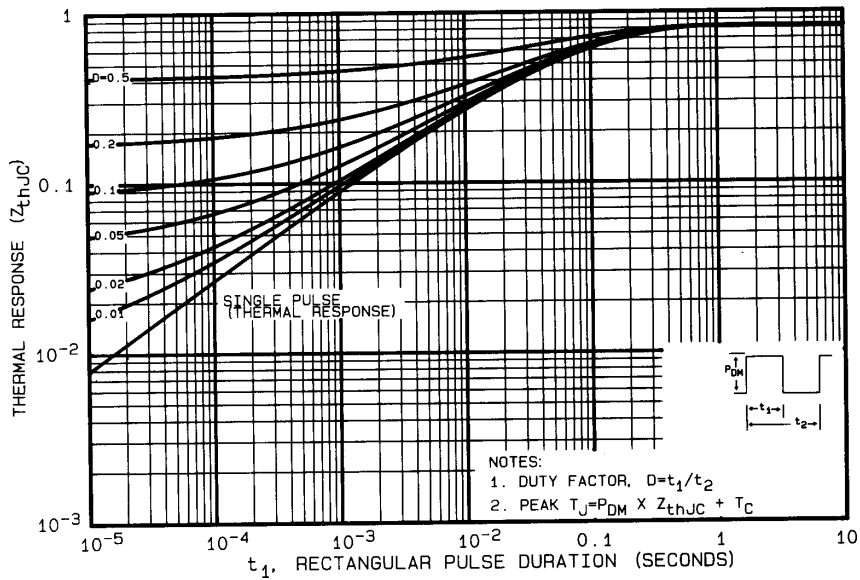

Fig 28. Maximum Effective Transient Thermal Impedance, Junction-to-Case

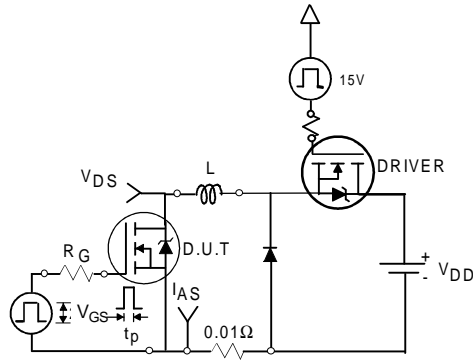

Fig 29a. Unclamped Inductive Test Circuit

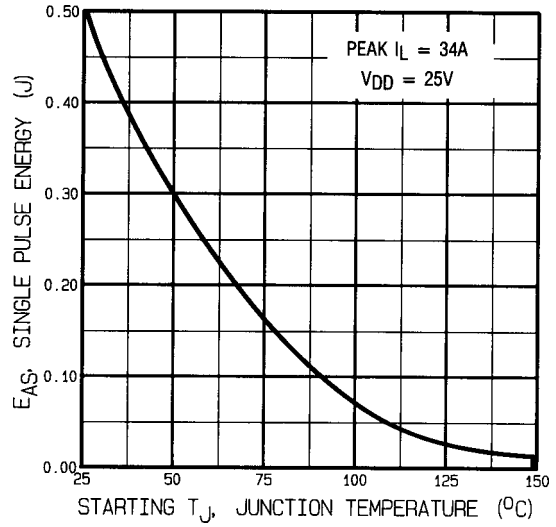

Fig 29c. Maximum Avalanche Energy Vs. Drain Current

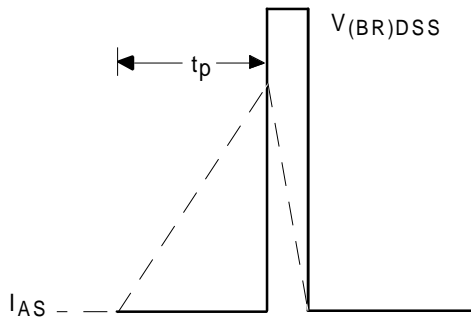

Fig 29b. Unclamped Inductive Waveforms

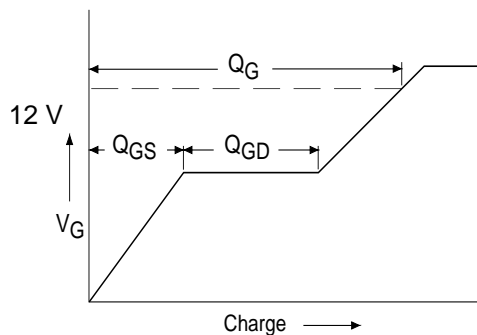

Fig 30a. Basic Gate Charge Waveform

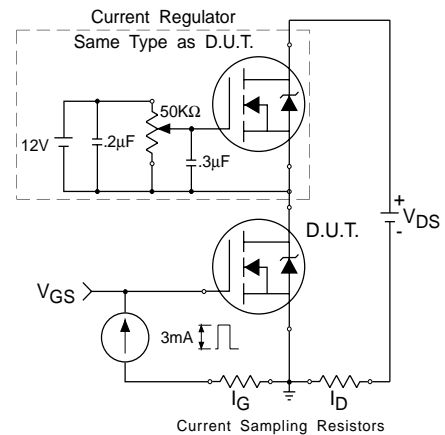
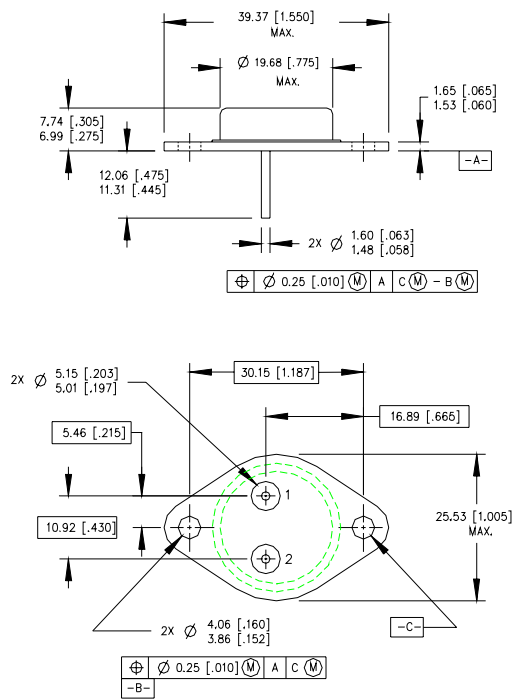

Fig 30b. Gate Charge Test Circuit

Foot Notes:

- ① Repetitive Rating; Pulse width limited by maximum junction temperature.
- ② $V_{DD} = 25V$, starting $T_J = 25^\circ C$, $L=0.86mH$
Peak $I_L = 34A$, $V_{GS} = 12V$
- ③ $I_{SD} \leq 34A$, $di/dt \leq 140A/\mu s$,
 $V_{DD} \leq 100V$, $T_J \leq 150^\circ C$
- ④ Pulse width $\leq 300 \mu s$; Duty Cycle $\leq 2\%$
- ⑤ **Total Dose Irradiation with V_{GS} Bias.**
12 volt V_{GS} applied and $V_{DS} = 0$ during irradiation per MIL-STD-750, method 1019, condition A.
- ⑥ **Total Dose Irradiation with V_{DS} Bias.**
80 volt V_{DS} applied and $V_{GS} = 0$ during irradiation per MIL-STD-750, method 1019, condition A.

Case Outline and Dimensions — TO-204AE



IR WORLD HEADQUARTERS: 233 Kansas St., El Segundo, California 90245, USA Tel: (310) 252-7105
TAC Fax: (310) 252-7903

Visit us at www.irf.com for sales contact information.
Data and specifications subject to change without notice. 03/01