

RADIATION HARDENED POWER MOSFET SURFACE MOUNT (SMD-1)

IRHN7250SE 200V, N-CHANNEL RAD Hard™ HEXFET® TECHNOLOGY

Product Summary

Part Number	Radiation Level	RDS(on)	ID
IRHN7250SE	100K Rads (Si)	0.10Ω	26A

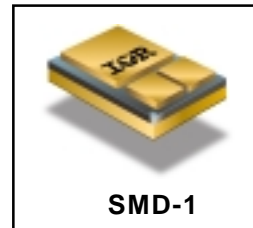

International Rectifier's RADHard™ HEXFET® MOSFET technology provides high performance power MOSFETs for space applications. This technology has over a decade of proven performance and reliability in satellite applications. These devices have been characterized for both Total Dose and Single Event Effects (SEE). The combination of low RDS(on) and low gate charge reduces the power losses in switching applications such as DC to DC converters and motor control. These devices retain all of the well established advantages of MOSFETs such as voltage control, fast switching, ease of paralleling and temperature stability of electrical parameters.

Features:

- Single Event Effect (SEE) Hardened
- Ultra Low RDS(on)
- Low Total Gate Charge
- Proton Tolerant
- Simple Drive Requirements
- Ease of Paralleling
- Hermetically Sealed
- Surface Mount
- Light Weight

Absolute Maximum Ratings

Pre-Irradiation

	Parameter		Units
ID @ VGS = 12V, TC = 25°C	Continuous Drain Current	26	A
ID @ VGS = 12V, TC = 100°C	Continuous Drain Current	16	
IDM	Pulsed Drain Current ①	104	
PD @ TC = 25°C	Max. Power Dissipation	150	W
	Linear Derating Factor	1.2	W/°C
VGS	Gate-to-Source Voltage	±20	V
EAS	Single Pulse Avalanche Energy ②	500	mJ
IAR	Avalanche Current ①	26	A
EAR	Repetitive Avalanche Energy ①	15	mJ
dv/dt	Peak Diode Recovery dv/dt ③	5.9	V/ns
TJ	Operating Junction	-55 to 150	°C
TSTG	Storage Temperature Range		
	Package Mounting Surface Temperature	300 (for 5 sec.)	
	Weight	2.6 (Typical)	g

For footnotes refer to the last page

Electrical Characteristics @ T_j = 25°C (Unless Otherwise Specified)

	Parameter	Min	Typ	Max	Units	Test Conditions
BV _{DSS}	Drain-to-Source Breakdown Voltage	200	—	—	V	V _{GS} = 0V, I _D = 1.0mA
ΔBV _{DSS} /ΔT _J	Temperature Coefficient of Breakdown Voltage	—	0.26	—	V/°C	Reference to 25°C, I _D = 1.0mA
R _{DSS(on)}	Static Drain-to-Source On-State Resistance	—	—	0.10	Ω	V _{GS} = 12V, I _D = 16A
		—	—	0.105		V _{GS} = 12V, I _D = 26A ④
V _{GS(th)}	Gate Threshold Voltage	2.5	—	4.5	V	V _{DS} = V _{GS} , I _D = 1.0mA
g _{fs}	Forward Transconductance	7.5	—	—	S (τ)	V _{DS} > 15V, I _{DS} = 16A ④
I _{DSS}	Zero Gate Voltage Drain Current	—	—	25	μA	V _{DS} = 160V, V _{GS} = 0V
		—	—	250		V _{DS} = 160V, V _{GS} = 0V, T _J = 125°C
I _{GSS}	Gate-to-Source Leakage Forward	—	—	100	nA	V _{GS} = 20V
I _{GSS}	Gate-to-Source Leakage Reverse	—	—	-100		V _{GS} = -20V
Q _g	Total Gate Charge	—	—	180	nC	V _{GS} = 12V, I _D = 26A
Q _{gs}	Gate-to-Source Charge	—	—	35		V _{DS} = 100V
Q _{gd}	Gate-to-Drain ('Miller') Charge	—	—	83		
t _{d(on)}	Turn-On Delay Time	—	—	33	ns	V _{DD} = 100V, I _D = 26A, V _{GS} = 12V, R _G = 2.35Ω
t _r	Rise Time	—	—	140		
t _{d(off)}	Turn-Off Delay Time	—	—	140		
t _f	Fall Time	—	—	140		
L _S + L _D	Total Inductance	—	4.0	—	nH	Measured from the center of drain pad to center of source pad
C _{iss}	Input Capacitance	—	3100	—	pF	V _{GS} = 0V, V _{DS} = 25V f = 1.0MHz
C _{oss}	Output Capacitance	—	990	—		
C _{rss}	Reverse Transfer Capacitance	—	380	—		

Source-Drain Diode Ratings and Characteristics

	Parameter	Min	Typ	Max	Units	Test Conditions
I _S	Continuous Source Current (Body Diode)	—	—	26	A	
I _{SM}	Pulse Source Current (Body Diode) ①	—	—	104		
V _{SD}	Diode Forward Voltage	—	—	1.9	V	T _J = 25°C, I _S = 26A, V _{GS} = 0V ④
t _{rr}	Reverse Recovery Time	—	—	550	nS	T _J = 25°C, I _F = 26A, di/dt ≤ 100A/μs
Q _{RR}	Reverse Recovery Charge	—	—	8.8	μC	V _{DD} ≤ 50V ④
t _{on}	Forward Turn-On Time	Intrinsic turn-on time is negligible. Turn-on speed is substantially controlled by L _S + L _D .				

Thermal Resistance

	Parameter	Min	Typ	Max	Units	Test Conditions
R _{thJC}	Junction-to-Case	—	—	0.83	°C/W	Soldered to a 1 inch square clad PC board
R _{thJ-PCB}	Junction-to-PC board	—	6.6	—		

Note: Corresponding Spice and Saber models are available on the G&S Website.

For footnotes refer to the last page

International Rectifier Radiation Hardened MOSFETs are tested to verify their radiation hardness capability. The hardness assurance program at International Rectifier is comprised of two radiation environments. Every manufacturing lot is tested for total ionizing dose (per notes 5 and 6) using the TO-3 package. Both pre- and post-irradiation performance are tested and specified using the same drive circuitry and test conditions in order to provide a direct comparison.

Table 1. Electrical Characteristics @ Tj = 25°C, Post Total Dose Irradiation ⑤⑥

	Parameter	100K Rads (Si)		Units	Test Conditions ⑧
		Min	Max		
BV _{DSS}	Drain-to-Source Breakdown Voltage	200	—	V	V _{GS} = 0V, I _D = 1.0mA
V _{GS(th)}	Gate Threshold Voltage	2.0	4.5		V _{GS} = V _{DS} , I _D = 1.0mA
I _{GSS}	Gate-to-Source Leakage Forward	—	100	nA	V _{GS} = 20V
I _{GSS}	Gate-to-Source Leakage Reverse	—	-100		V _{GS} = -20V
I _{DSS}	Zero Gate Voltage Drain Current	—	25	μA	V _{DS} = 160V, V _{GS} = 0V
R _{DS(on)}	Static Drain-to-Source ④ On-State Resistance (TO-3)	—	0.10	Ω	V _{GS} = 12V, I _D = 16A
R _{DS(on)}	Static Drain-to-Source ④ On-State Resistance (SMD-1)	—	0.10	Ω	V _{GS} = 12V, I _D = 16A
V _{SD}	Diode Forward Voltage ④	—	1.9	V	V _{GS} = 0V, I _D = 26A

International Rectifier radiation hardened MOSFETs have been characterized in heavy ion environment for Single Event Effects (SEE). Single Event Effects characterization is illustrated in Fig. a and Table 2.

Table 2. Single Event Effect Safe Operating Area

Ion	LET MeV/(mg/cm ²)	Energy (MeV)	Range (μm)	V _{DS} (V)				
				@V _{GS} =0V	@V _{GS} =-5V	@V _{GS} =-10V	@V _{GS} =-15V	@V _{GS} =-20V
Cu	28	285	43	200	200	200	200	200
Br	36.8	305	39	200	200	200	180	140

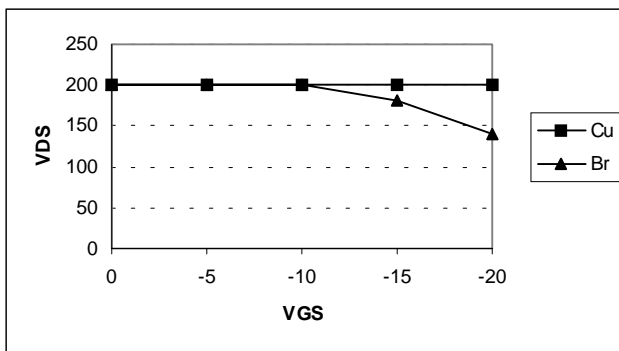

Fig a. Single Event Effect, Safe Operating Area

For footnotes refer to the last page

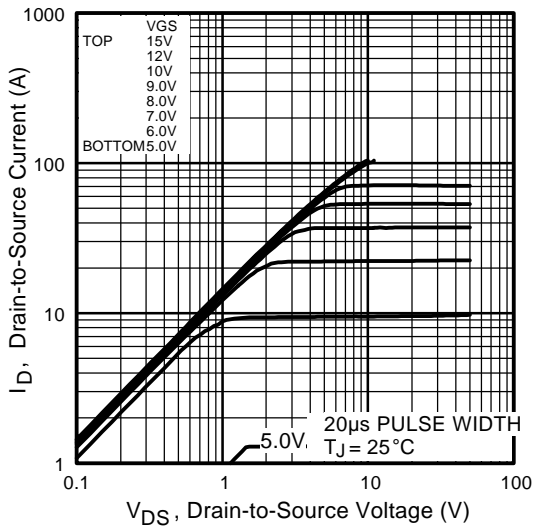

Fig 1. Typical Output Characteristics

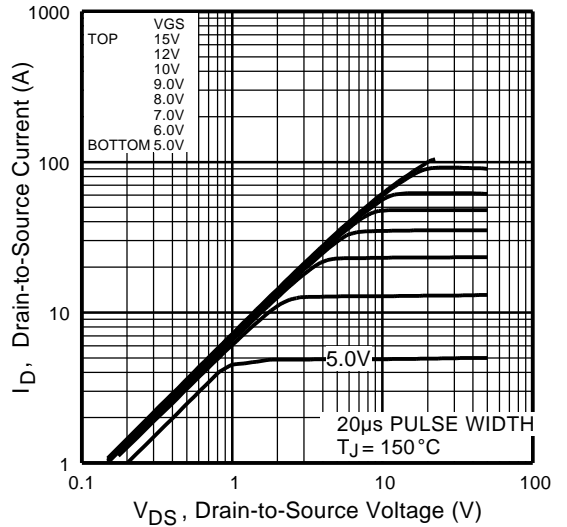

Fig 2. Typical Output Characteristics

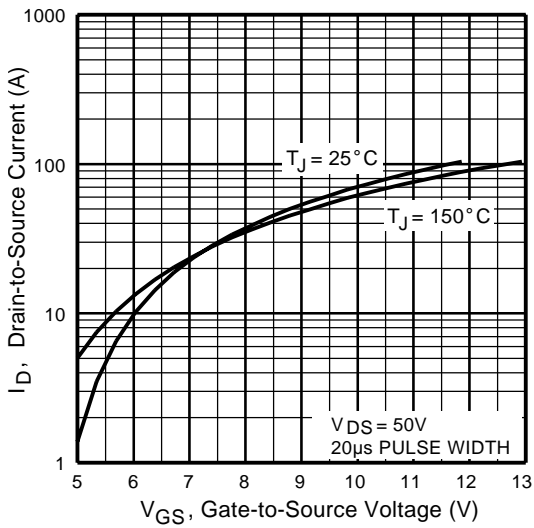

Fig 3. Typical Transfer Characteristics

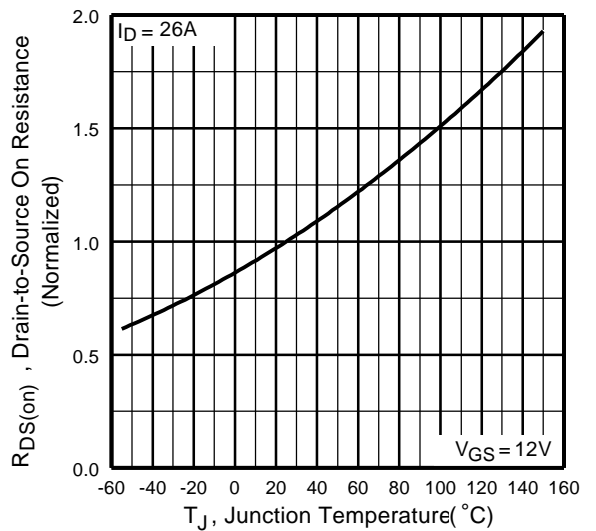

Fig 4. Normalized On-Resistance Vs. Temperature

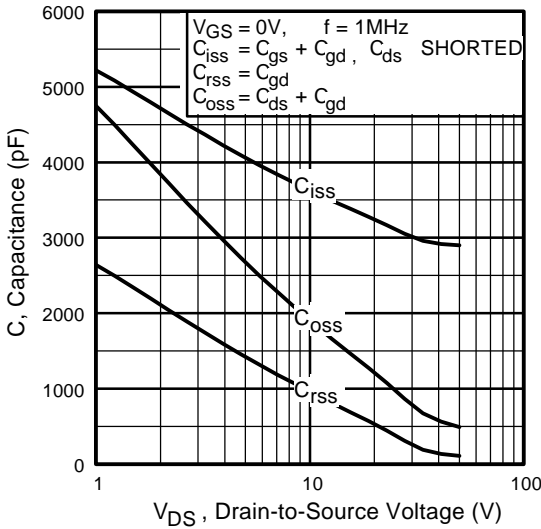

Fig 5. Typical Capacitance Vs. Drain-to-Source Voltage

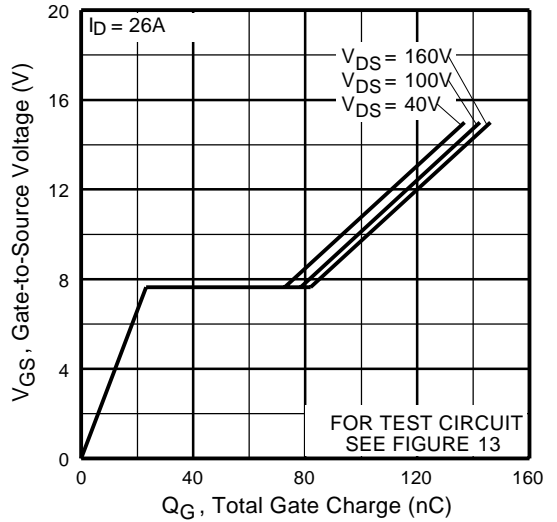

Fig 6. Typical Gate Charge Vs. Gate-to-Source Voltage

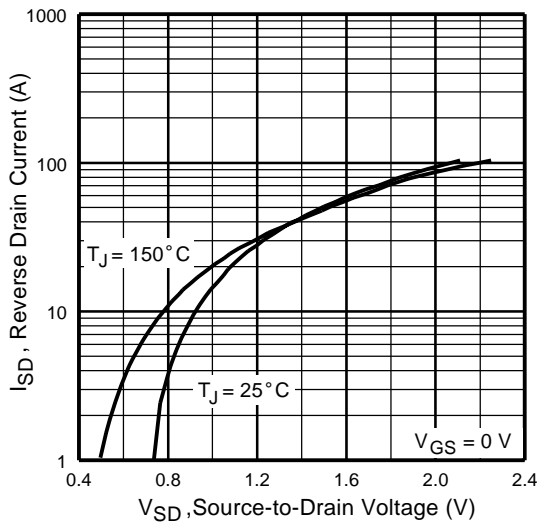

Fig 7. Typical Source-Drain Diode Forward Voltage

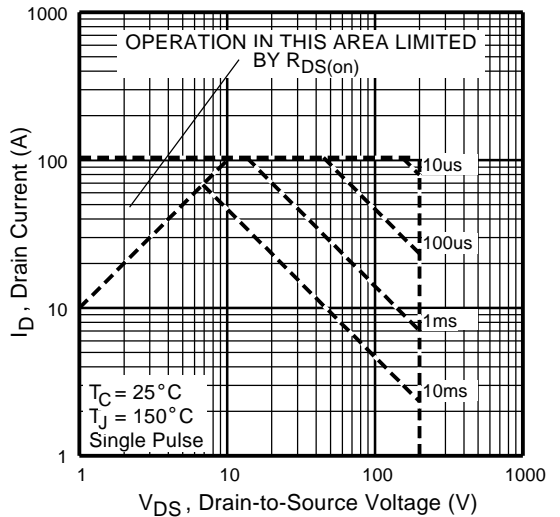

Fig 8. Maximum Safe Operating Area

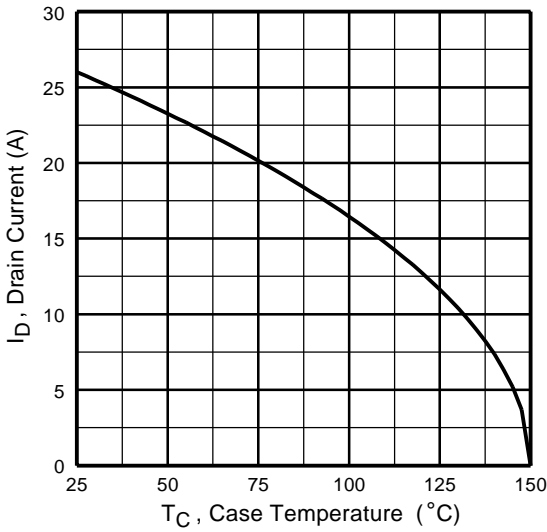

Fig 9. Maximum Drain Current Vs. Case Temperature

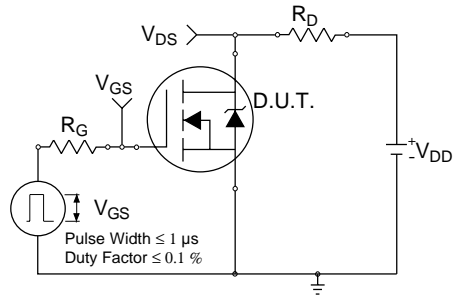

Fig 10a. Switching Time Test Circuit

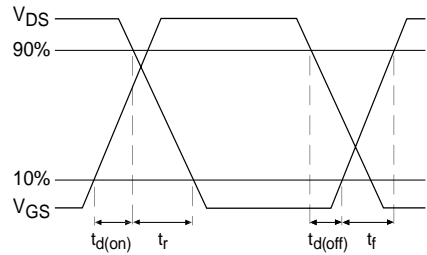

Fig 10b. Switching Time Waveforms

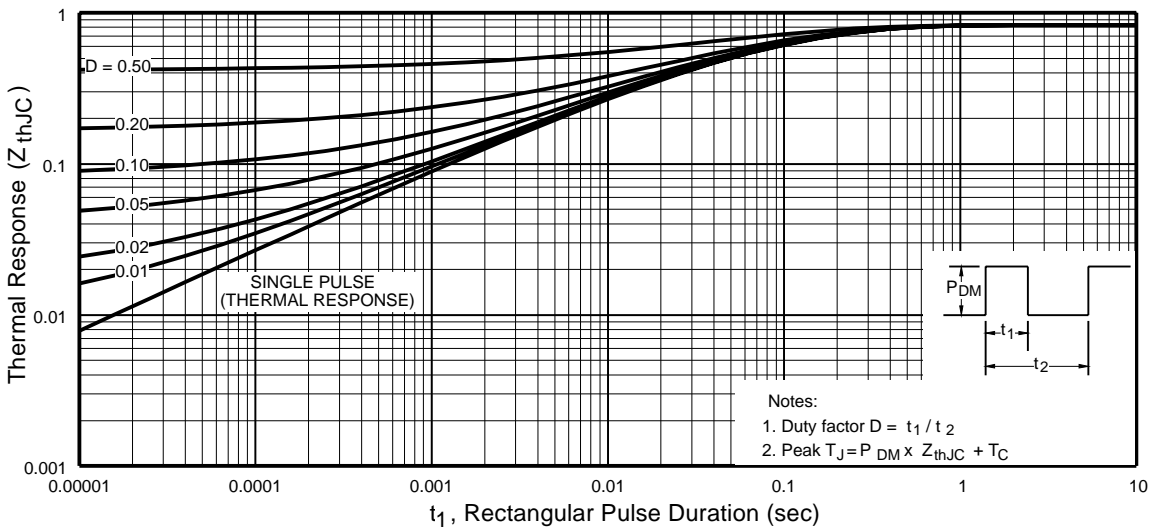

Fig 11. Maximum Effective Transient Thermal Impedance, Junction-to-Case

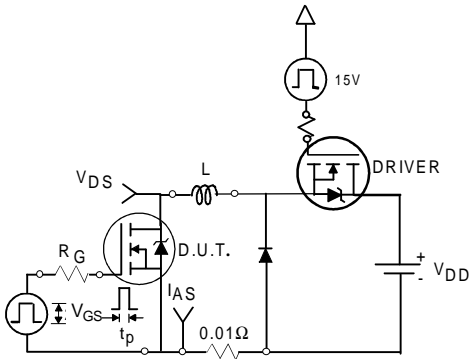

Fig 12a. Unclamped Inductive Test Circuit

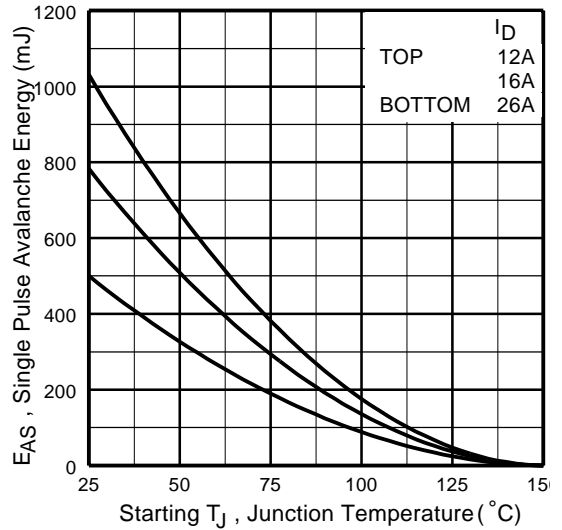

Fig 12c. Maximum Avalanche Energy Vs. Drain Current

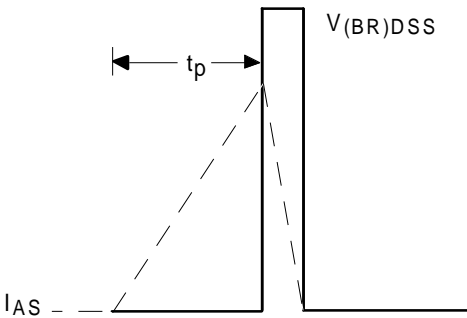

Fig 12b. Unclamped Inductive Waveforms

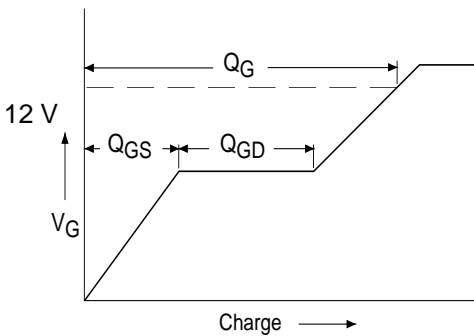

Fig 13a. Basic Gate Charge Waveform

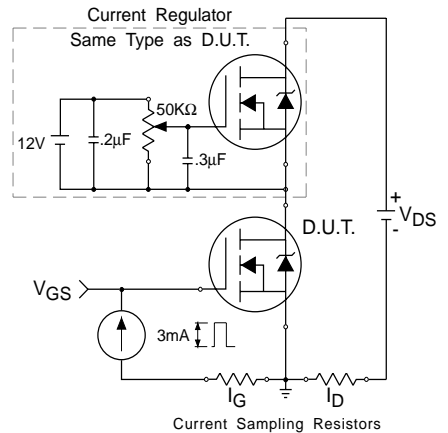
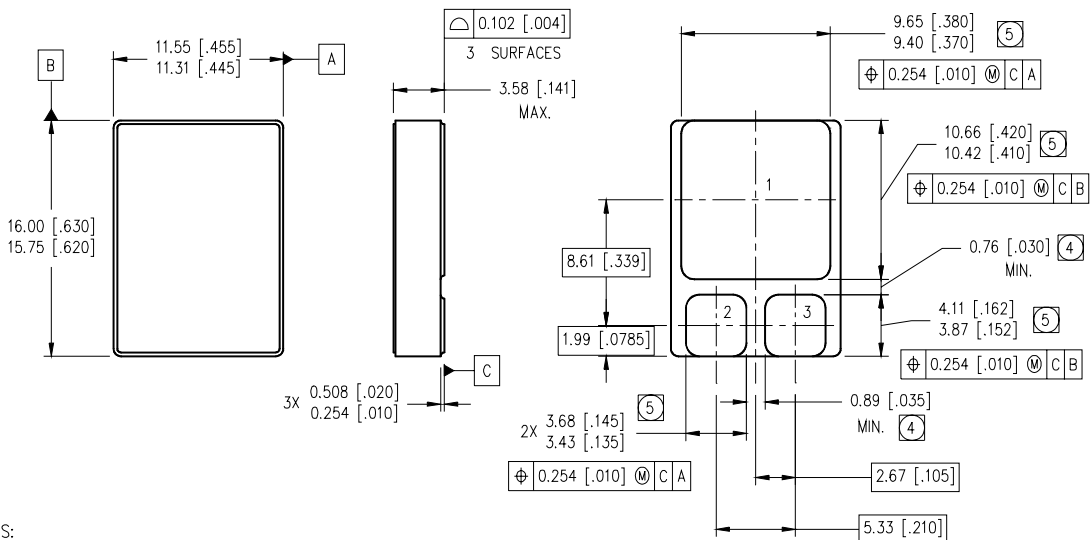

Fig 13b. Gate Charge Test Circuit

Footnotes:

- ① Repetitive Rating; Pulse width limited by maximum junction temperature.
- ② $V_{DD} = 50V$, starting $T_J = 25^\circ C$, $L = 1.5\text{ mH}$
Peak $I_L = 26A$, $V_{GS} = 12V$
- ③ $I_{SD} \leq 26A$, $di/dt \leq 400A/\mu s$,
 $V_{DD} \leq 200V$, $T_J \leq 150^\circ C$
- ④ Pulse width $\leq 300\ \mu s$; Duty Cycle $\leq 2\%$
- ⑤ **Total Dose Irradiation with V_{GS} Bias.**
12 volt V_{GS} applied and $V_{DS} = 0$ during irradiation per MIL-STD-750, method 1019, condition A.
- ⑥ **Total Dose Irradiation with V_{DS} Bias.**
160 volt V_{DS} applied and $V_{GS} = 0$ during irradiation per MIL-STD-750, method 1019, condition A.

Case Outline and Dimensions —SMD-1



NOTES:

- 1. DIMENSIONING & TOLERANCING PER ASME Y14.5M-1994.
- 2. CONTROLLING DIMENSION: INCH.
- 3. DIMENSIONS ARE SHOWN IN MILLIMETERS [INCHES].
- ④ DIMENSION INCLUDES METALLIZATION FLASH.
- ⑤ DIMENSION DOES NOT INCLUDE METALLIZATION FLASH.

PAD ASSIGNMENTS

- 1 = DRAIN
- 2 = GATE
- 3 = SOURCE

International
IR Rectifier

IR WORLD HEADQUARTERS: 233 Kansas St., El Segundo, California 90245, USA Tel: (310) 252-7105
TAC Fax: (310) 252-7903

Visit us at www.irf.com for sales contact information.
Data and specifications subject to change without notice. 05/01