

PRELIMINARY

PD-97200B

International  
**IR** Rectifier

**RADIATION HARDENED  
LOGIC LEVEL POWER MOSFET  
THRU-HOLE (MO-036AB)**

**2N7628M1  
IRHLG7970Z4  
60V, Quad P-CHANNEL**

**R7™ TECHNOLOGY**

**Product Summary**

Part Number	Radiation Level	RDS(on)	ID
IRHLG7970Z4	100K Rads (Si)	1.25Ω	-0.71A
IRHLG7930Z4	300K Rads (Si)	1.25Ω	-0.71A



International Rectifier's R7™ Logic Level Power MOSFETs provide simple solution to interfacing CMOS and TTL control circuits to power devices in space and other radiation environments. The threshold voltage remains within acceptable operating limits over the full operating temperature and post radiation. This is achieved while maintaining single event gate rupture and single event burnout immunity. These devices are used in applications such as current boost low signal source in PWM, voltage comparator and operational amplifiers.

**Features:**

- 5V CMOS and TTL Compatible
- Fast Switching
- Single Event Effect (SEE) Hardened
- Low Total Gate Charge
- Simple Drive Requirements
- Ease of Paralleling
- Hermetically Sealed
- Ceramic Package
- Light Weight
- Complimentary N-Channel Available - IRHLG770Z4

**Absolute Maximum Ratings (Per Die)**

**Pre-Irradiation**

	Parameter		Units
ID @ VGS = -4.5V, TC=25°C	Continuous Drain Current	-0.71	A
ID @ VGS = -4.5V, TC=100°C	Continuous Drain Current	-0.45	
IDM	Pulsed Drain Current ①	-2.84	
PD @ TC = 25°C	Max. Power Dissipation	1.0	W
	Linear Derating Factor	0.01	W/°C
VGS	Gate-to-Source Voltage	±10	V
EAS	Single Pulse Avalanche Energy ②	21	mJ
IAR	Avalanche Current ①	-0.71	A
EAR	Repetitive Avalanche Energy ①	0.1	mJ
dv/dt	Peak Diode Recovery dv/dt ③	-14	V/ns
TJ	Operating Junction	-55 to 150	°C
TSTG	Storage Temperature Range		
	Lead Temperature	300 (0.63 in./1.6 mm from case for 10s)	
	Weight	1.3 (Typical)	g

For footnotes refer to the last page

www.irf.com

## PRELIMINARY

IRHLG7970Z4, 2N7628M1

Pre-Irradiation

### Electrical Characteristics For Each P-Channel Device @T<sub>j</sub> = 25°C (Unless Otherwise specified)

	Parameter	Min	Typ	Max	Units	Test Conditions
B <sub>V</sub> D <sub>SS</sub>	Drain-to-Source Breakdown Voltage	-60	—	—	V	V <sub>GS</sub> = 0V, I <sub>D</sub> = -250μA
ΔB <sub>V</sub> D <sub>SS</sub> /ΔT <sub>J</sub>	Temperature Coefficient of Breakdown Voltage	—	-0.08	—	V/°C	Reference to 25°C, I <sub>D</sub> = -1.0mA
R <sub>DS(on)</sub>	Static Drain-to-Source On-State Resistance	—	—	1.25	Ω	V <sub>GS</sub> = -4.5V, I <sub>D</sub> = -0.45A <sup>④</sup>
V <sub>GS(th)</sub>	Gate Threshold Voltage	-1.0	—	-2.0	V	V <sub>DS</sub> = V <sub>GS</sub> , I <sub>D</sub> = -250μA
ΔV <sub>GS(th)</sub> /ΔT <sub>J</sub>	Gate Threshold Voltage Coefficient	—	3.07	—	mV/°C	
g <sub>fs</sub>	Forward Transconductance	0.9	—	—	S	V <sub>DS</sub> = -10V, I <sub>DS</sub> = -0.45A <sup>④</sup>
I <sub>DSS</sub>	Zero Gate Voltage Drain Current	—	—	-1.0	μA	V <sub>DS</sub> = -48V, V <sub>GS</sub> = 0V
		—	—	-10		V <sub>DS</sub> = -48V, V <sub>GS</sub> = 0V, T <sub>J</sub> = 125°C
I <sub>GSS</sub>	Gate-to-Source Leakage Forward	—	—	-100	nA	V <sub>GS</sub> = -10V
I <sub>GSS</sub>	Gate-to-Source Leakage Reverse	—	—	100		V <sub>GS</sub> = 10V
Q <sub>g</sub>	Total Gate Charge	—	—	2.8	nC	V <sub>GS</sub> = -4.5V, I <sub>D</sub> = -0.71A V <sub>DS</sub> = -30V
Q <sub>gs</sub>	Gate-to-Source Charge	—	—	1.7		
Q <sub>gd</sub>	Gate-to-Drain ('Miller') Charge	—	—	0.8		
t <sub>d(on)</sub>	Turn-On Delay Time	—	—	17	ns	V <sub>DD</sub> = -30V, I <sub>D</sub> = -0.71A, V <sub>GS</sub> = -5.0V, R <sub>G</sub> = 24Ω
t <sub>r</sub>	Rise Time	—	—	20		
t <sub>d(off)</sub>	Turn-Off Delay Time	—	—	27		
t <sub>f</sub>	Fall Time	—	—	23		
L <sub>S</sub> + L <sub>D</sub>	Total Inductance	—	10	—	nH	Measured from Drain lead (6mm /0.25in from pack.) to Source lead (6mm/0.25in from pack.)with Source wire internally bonded from Source pin to Drain pad
C <sub>iss</sub>	Input Capacitance	—	138	—	pF	V <sub>GS</sub> = 0V, V <sub>DS</sub> = -25V f = 1.0MHz
C <sub>oss</sub>	Output Capacitance	—	39	—		
C <sub>rss</sub>	Reverse Transfer Capacitance	—	6.7	—		
R <sub>g</sub>	Gate Resistance	—	52.4	—		

### Source-Drain Diode Ratings and Characteristics (Per Die)

	Parameter	Min	Typ	Max	Units	Test Conditions
I <sub>S</sub>	Continuous Source Current (Body Diode)	—	—	-0.71	A	
I <sub>SM</sub>	Pulse Source Current (Body Diode) <sup>①</sup>	—	—	-2.84		
V <sub>SD</sub>	Diode Forward Voltage	—	—	-5.0	V	T <sub>j</sub> = 25°C, I <sub>S</sub> = -0.71A, V <sub>GS</sub> = 0V <sup>④</sup>
t <sub>rr</sub>	Reverse Recovery Time	—	—	30	ns	T <sub>j</sub> = 25°C, I <sub>F</sub> = -0.71A, di/dt ≤ -100A/μs
Q <sub>RR</sub>	Reverse Recovery Charge	—	—	11	nC	V <sub>DD</sub> ≤ -25V <sup>④</sup>
t <sub>on</sub>	Forward Turn-On Time	Intrinsic turn-on time is negligible. Turn-on speed is substantially controlled by L <sub>S</sub> + L <sub>D</sub> .				

### Thermal Resistance (Per Die)

	Parameter	Min	Typ	Max	Units	Test Conditions
R <sub>thJA</sub>	Junction-to-Ambient	—	—	125	°C/W	Typical socket mount

**Note:** Corresponding Spice and Saber models are available International Rectifier Website.

For footnotes refer to the last page

## PRELIMINARY

### Radiation Characteristics

**IRHLG7970Z4, 2N7628M1**

International Rectifier Radiation Hardened MOSFETs are tested to verify their radiation hardness capability. The hardness assurance program at International Rectifier is comprised of two radiation environments. Every manufacturing lot is tested for total ionizing dose (per notes 5 and 6) using the TO-39 package. Both pre- and post-irradiation performance are tested and specified using the same drive circuitry and test conditions in order to provide a direct comparison.

**Table 1. Electrical Characteristics For Each P-Channel Device @Tj = 25°C, Post Total Dose Irradiation ⑤⑥**

	Parameter	Up to 300K Rads (Si) <sup>1</sup>		Units	Test Conditions
		Min	Max		
BV <sub>DSS</sub>	Drain-to-Source Breakdown Voltage	-60	—	V	V <sub>GS</sub> = 0V, I <sub>D</sub> = -250μA
V <sub>GS(th)</sub>	Gate Threshold Voltage	-1.0	-2.0		V <sub>GS</sub> = V <sub>DS</sub> , I <sub>D</sub> = -250μA
I <sub>GSS</sub>	Gate-to-Source Leakage Forward	—	-100	nA	V <sub>GS</sub> = -10V
I <sub>GSS</sub>	Gate-to-Source Leakage Reverse	—	100		V <sub>GS</sub> = 10V
I <sub>DSS</sub>	Zero Gate Voltage Drain Current	—	-1.0	μA	V <sub>DS</sub> = -48V, V <sub>GS</sub> = 0V
R <sub>DS(on)</sub>	Static Drain-to-Source On-State Resistance (TO-39)	—	1.20	Ω	V <sub>GS</sub> = -4.5V, I <sub>D</sub> = -0.45A
R <sub>DS(on)</sub>	Static Drain-to-Source On-state Resistance (MO-036)	—	1.25	Ω	V <sub>GS</sub> = -4.5V, I <sub>D</sub> = -0.45A
V <sub>SD</sub>	Diode Forward Voltage ④	—	-5.0	V	V <sub>GS</sub> = 0V, I <sub>D</sub> = -0.71A

1. Part numbers IRHLG7970Z4, IRHLG7930Z4

International Rectifier radiation hardened MOSFETs have been characterized in heavy ion environment for Single Event Effects (SEE). Single Event Effects characterization is illustrated in Fig. a and Table 2.

**Table 2. Typical Single Event Effect Safe Operating Area (Per Die)**

Ion	LET (MeV/(mg/cm <sup>2</sup> ))	Energy (MeV)	Range (μm)	VDS (V)							
				@VGS= 0V	@VGS= 2V	@VGS= 4V	@VGS= 5V	@VGS= 6V	@VGS= 7V	@VGS= 8V	@VGS= 10V
Br	37	305	39	-60	-60	-60	-60	-60	-50	-35	-25
I	60	370	34	-60	-60	-60	-60	-60	-20	-	-
Au	84	390	30	-60	-60	-60	-60	-	-	-	-

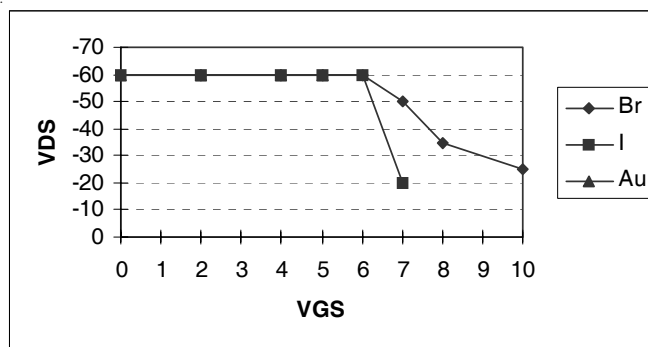

**Fig a.** Typical Single Event Effect, Safe Operating Area

For footnotes refer to the last page

PRELIMINARY

IRHLG7970Z4, 2N7628M1

Pre-Irradiation

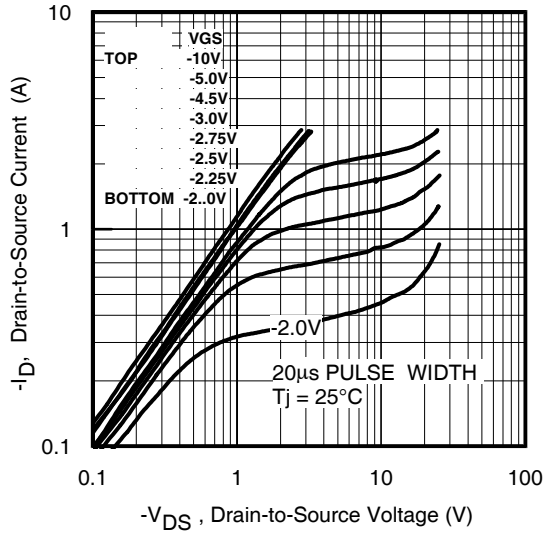

Fig 1. Typical Output Characteristics

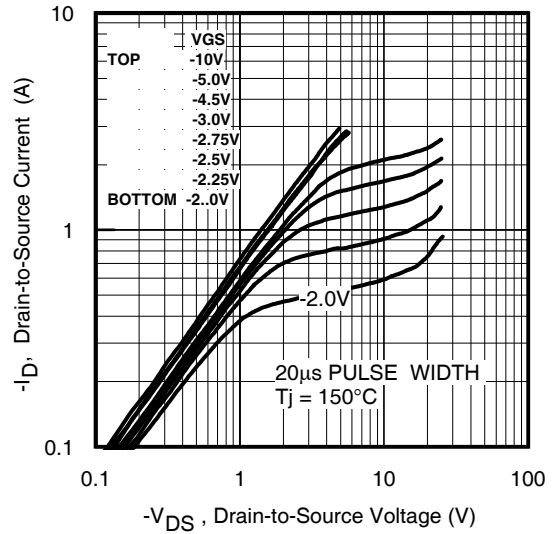

Fig 2. Typical Output Characteristics

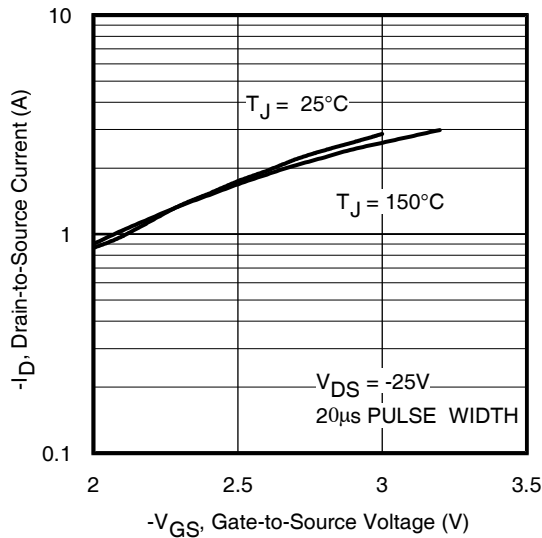

Fig 3. Typical Transfer Characteristics

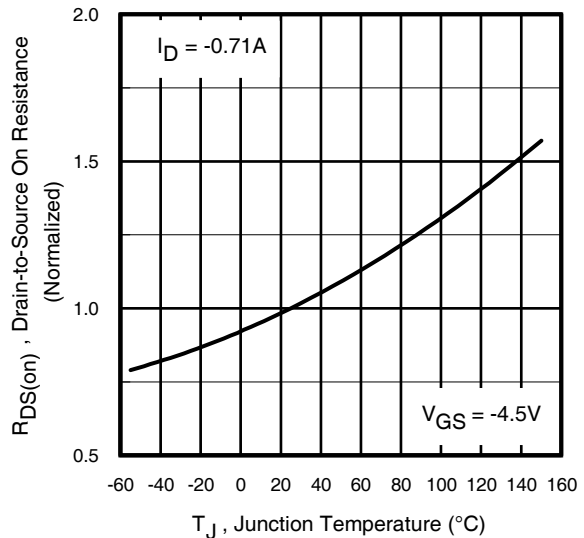

Fig 4. Normalized On-Resistance Vs. Temperature

PRELIMINARY

Pre-Irradiation

IRHLG7970Z4, 2N7628M1

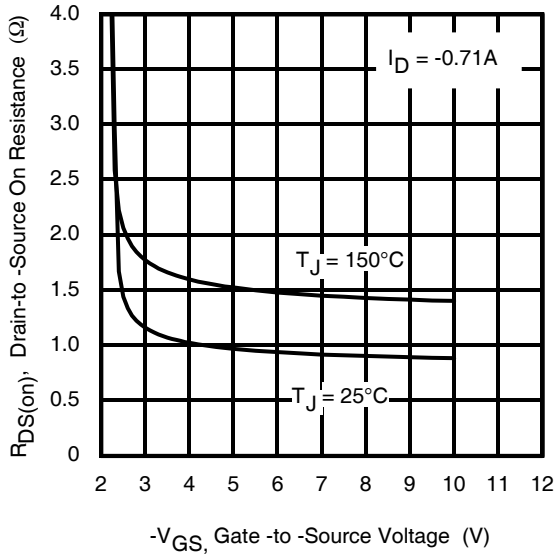

Fig 5. Typical On-Resistance Vs Gate Voltage

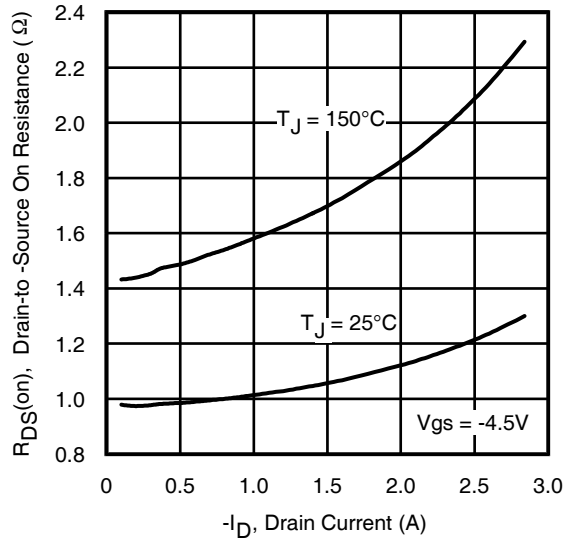

Fig 6. Typical On-Resistance Vs Drain Current

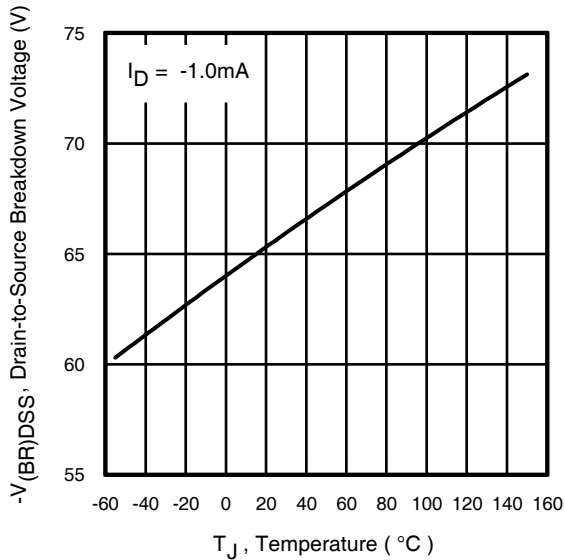

Fig 7. Typical Drain-to-Source Breakdown Voltage Vs Temperature

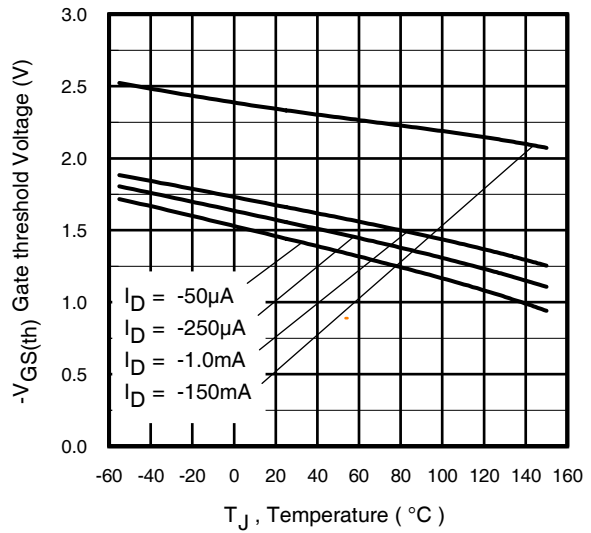

Fig 8. Typical Threshold Voltage Vs Temperature

PRELIMINARY

IRHLG7970Z4, 2N7628M1

Pre-Irradiation

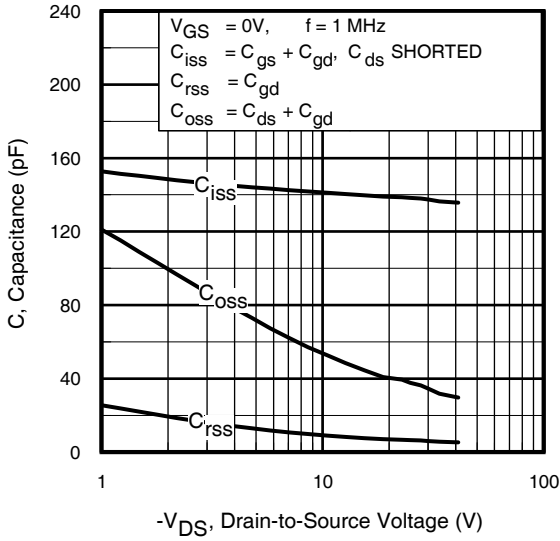

Fig 9. Typical Capacitance Vs. Drain-to-Source Voltage

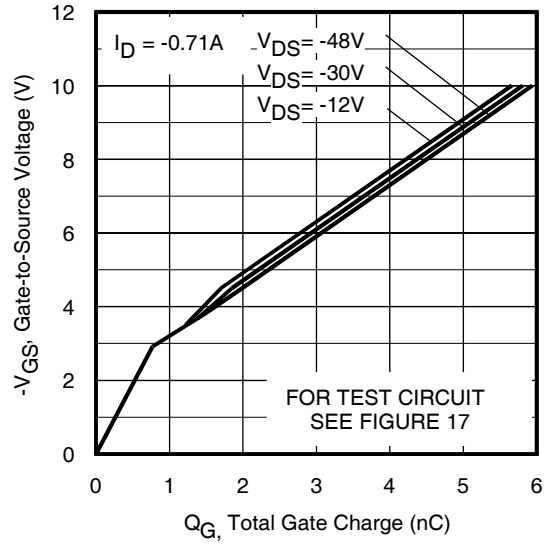

Fig 10. Typical Gate Charge Vs. Gate-to-Source Voltage

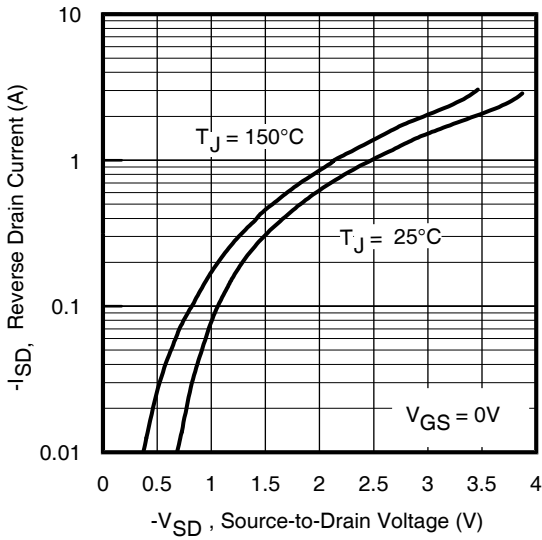

Fig 11. Typical Source-Drain Diode Forward Voltage

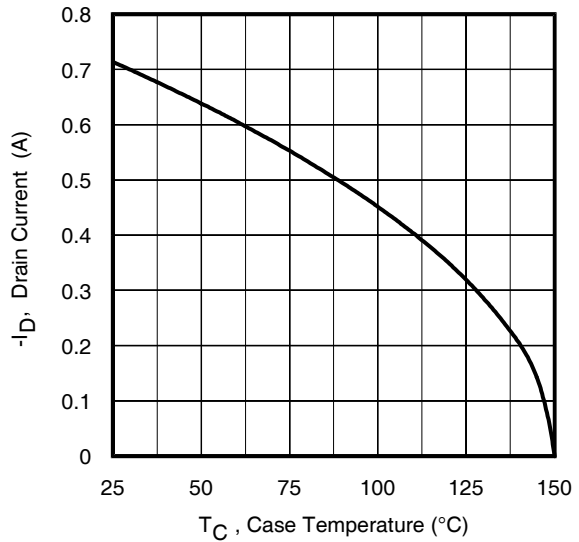

Fig 12. Maximum Drain Current Vs. Case Temperature

PRELIMINARY

Pre-Irradiation

IRHLG7970Z4, 2N7628M1

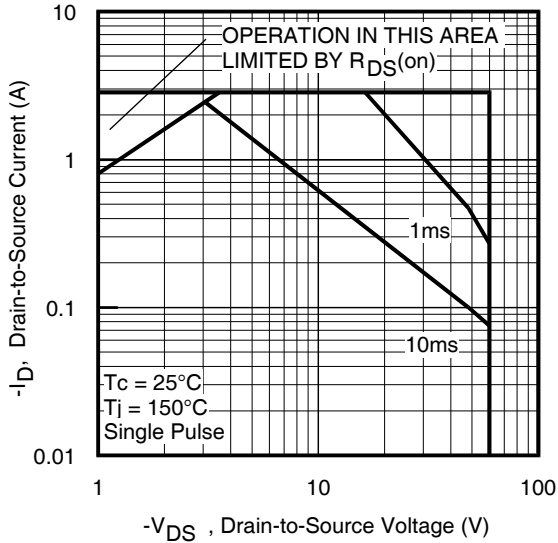

Fig 13. Maximum Safe Operating Area

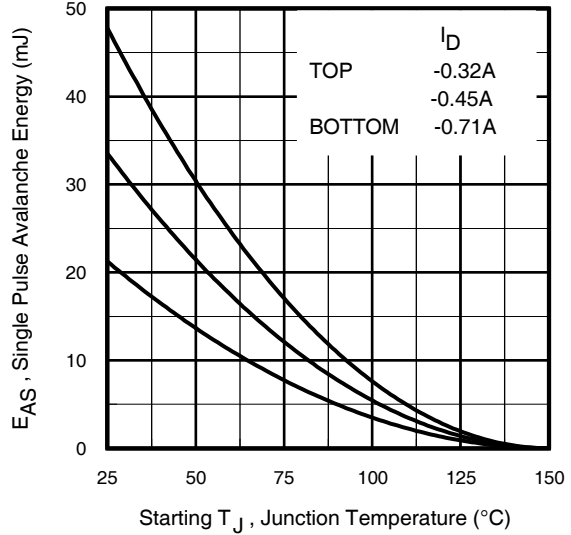

Fig 14. Maximum Avalanche Energy Vs. Drain Current

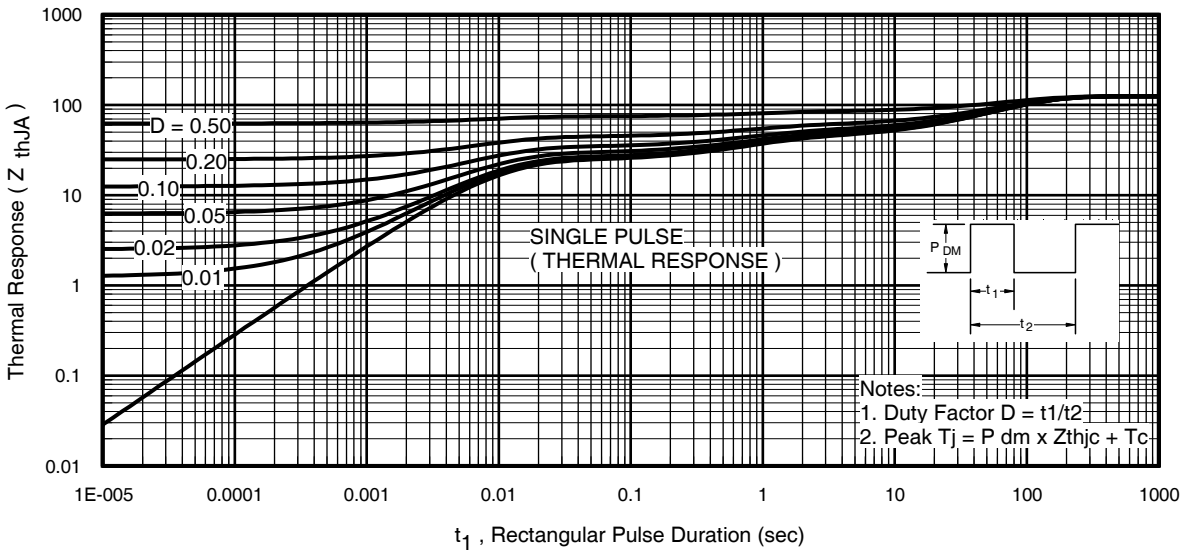

Fig 15. Maximum Effective Transient Thermal Impedance, Junction-to-Ambient

PRELIMINARY

IRHLG7970Z4, 2N7628M1

Pre-Irradiation

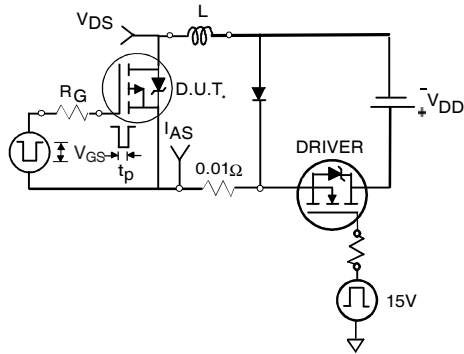

Fig 16a. Unclamped Inductive Test Circuit

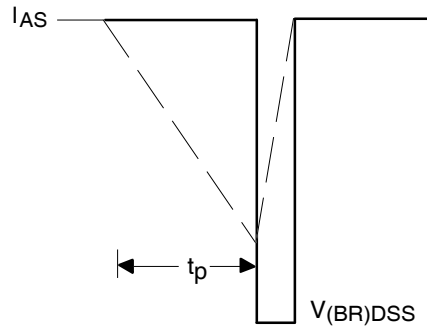

Fig 16b. Unclamped Inductive Waveforms

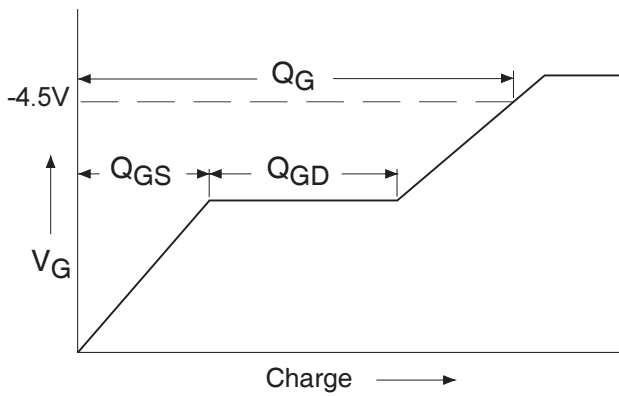

Fig 17a. Basic Gate Charge Waveform

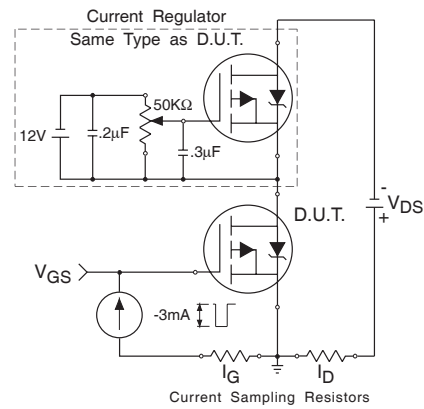

Fig 17b. Gate Charge Test Circuit

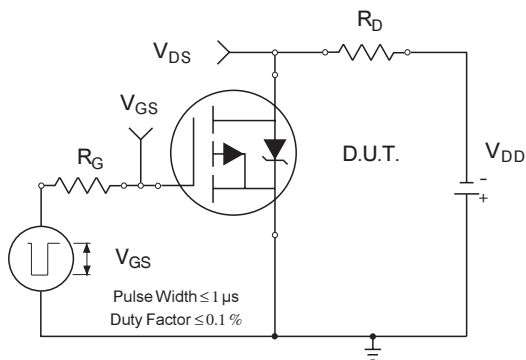

Fig 18a. Switching Time Test Circuit

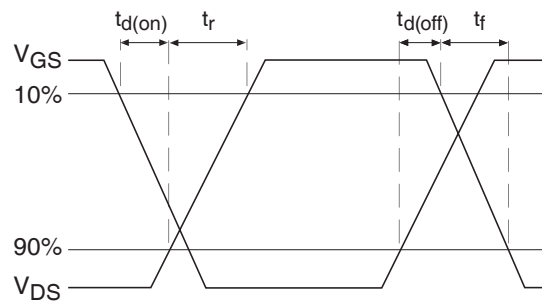

Fig 18b. Switching Time Waveforms



# PRELIMINARY

Pre-Irradiation

IRHLG7970Z4, 2N7628M1

## Footnotes:

- ① Repetitive Rating; Pulse width limited by maximum junction temperature.
- ②  $V_{DD} = -25V$ , starting  $T_J = 25^\circ C$ ,  $L = 85mH$   
Peak  $I_L = -0.71A$ ,  $V_{GS} = -10V$
- ③  $I_{SD} \leq -0.71A$ ,  $di/dt \leq -164A/\mu s$ ,  
 $V_{DD} \leq -60V$ ,  $T_J \leq 150^\circ C$
- ④ Pulse width  $\leq 300 \mu s$ ; Duty Cycle  $\leq 2\%$
- ⑤ **Total Dose Irradiation with  $V_{GS}$  Bias.**  
-10 volt  $V_{GS}$  applied and  $V_{DS} = 0$  during irradiation per MIL-STD-750, method 1019, condition A.
- ⑥ **Total Dose Irradiation with  $V_{DS}$  Bias.**  
-48 volt  $V_{DS}$  applied and  $V_{GS} = 0$  during irradiation per MIL-STD-750, method 1019, condition A.

## Case Outline and Dimensions — MO-036AB

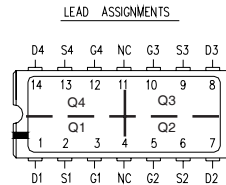
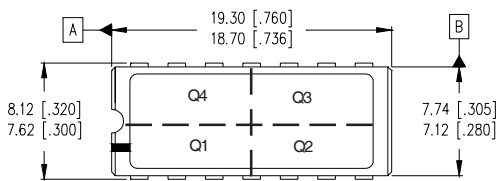

LEGEND  
 G = GATE      S = SOURCE  
 D = DRAIN    NC = NO CONNECTION

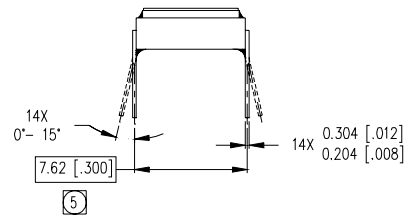
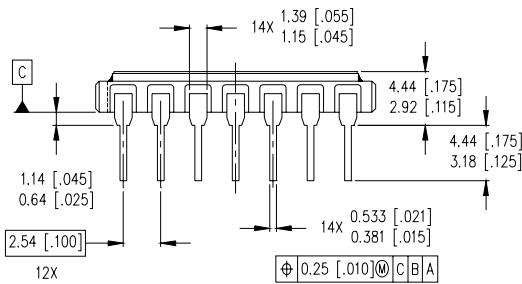

### NOTES:

1. DIMENSIONING & TOLERANCING PER ASME Y14.5M-1994.
2. CONTROLLING DIMENSION: INCH.
3. DIMENSIONS ARE SHOWN IN MILLIMETERS [INCHES].
4. OUTLINE CONFORMS TO JEDEC OUTLINE MO-036AB.
- ⑤ MEASURED WITH THE LEADS CONSTRAINED TO BE PERPENDICULAR TO DATUM PLANE C.

International  
**IR** Rectifier

IR WORLD HEADQUARTERS: 233 Kansas St., El Segundo, California 90245, USA Tel: (310) 252-7105  
 IR LEOMINSTER : 205 Crawford St., Leominster, Massachusetts 01453, USA Tel: (978) 534-5776  
 TAC Fax: (310) 252-7903

Visit us at [www.irf.com](http://www.irf.com) for sales contact information.  
 Data and specifications subject to change without notice. 03/2011