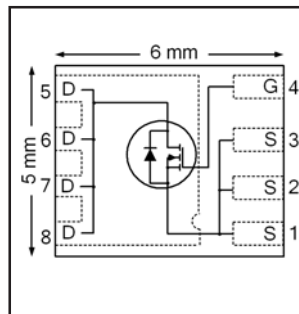


HEXFET® Power MOSFET

$V_{DS}$	<b>150</b>	<b>V</b>
$R_{DS(on) max}$ (@ $V_{GS} = 10V$ )	<b>31</b>	<b>mΩ</b>
$Q_g$ (typical)	<b>36</b>	<b>nC</b>
$R_G$ (typical)	<b>1.7</b>	<b>Ω</b>
$I_D$ (@ $T_{mb} = 25°C$ )	<b>44</b>	<b>A</b>



### Applications

- Primary Side Synchronous Rectification
- Inverters for DC Motors
- DC-DC Brick Applications
- Boost Converters

### Features and Benefits

#### Features

Low $R_{DS(on)}$ (< 31 mΩ)
Low Thermal Resistance to PCB (<0.8°C/W)
100% Rg tested
Low Profile (<0.9 mm)
Industry-Standard Pinout
Compatible with Existing Surface Mount Techniques
RoHS Compliant Containing no Lead, no Bromide and no Halogen
MSL1, Industrial Qualification

#### Benefits

Lower Conduction Losses
Increased Power Density
Increased Reliability
Increased Power Density
Multi-Vendor Compatibility
Easier Manufacturing
Environmentally Friendlier
Increased Reliability

results in  
⇒

Base Part Number	Package Type	Standard Pack		Orderable Part Number
		Form	Quantity	
IRFH5015PBF	PQFN 5mm x 6mm	Tape and Reel	4000	IRFH5015TRPBF

### Absolute Maximum Ratings

	Parameter	Max.	Units
$V_{DS}$	Drain-to-Source Voltage	150	V
$V_{GS}$	Gate-to-Source Voltage	± 20	
$I_D @ T_A = 25°C$	Continuous Drain Current, $V_{GS} @ 10V$	10	A
$I_D @ T_A = 70°C$	Continuous Drain Current, $V_{GS} @ 10V$	8.2	
$I_D @ T_{mb} = 25°C$	Continuous Drain Current, $V_{GS} @ 10V$	44	
$I_D @ T_{mb} = 100°C$	Continuous Drain Current, $V_{GS} @ 10V$	28	
$I_{DM}$	Pulsed Drain Current ①	220	
$P_D @ T_A = 25°C$	Power Dissipation ⑤	3.6	W
$P_D @ T_{mb} = 25°C$	Power Dissipation ⑤	156	
	Linear Derating Factor ⑤	0.029	W/°C
$T_J$ $T_{STG}$	Operating Junction and Storage Temperature Range	-55 to + 150	°C

Notes ① through ⑤ are on page 8

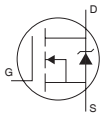
**Static @ T<sub>J</sub> = 25°C (unless otherwise specified)**

	Parameter	Min.	Typ.	Max.	Units	Conditions
BV <sub>DSS</sub>	Drain-to-Source Breakdown Voltage	150	—	—	V	V <sub>GS</sub> = 0V, I <sub>D</sub> = 250μA
ΔBV <sub>DSS</sub> /ΔT <sub>J</sub>	Breakdown Voltage Temp. Coefficient	—	0.12	—	V/°C	Reference to 25°C, I <sub>D</sub> = 1.0mA
R <sub>DS(on)</sub>	Static Drain-to-Source On-Resistance	—	25.5	31	mΩ	V <sub>GS</sub> = 10V, I <sub>D</sub> = 34A ③
V <sub>GS(th)</sub>	Gate Threshold Voltage	3.0	—	5.0	V	V <sub>DS</sub> = V <sub>GS</sub> , I <sub>D</sub> = 150μA
ΔV <sub>GS(th)</sub>	Gate Threshold Voltage Coefficient	—	-12	—	mV/°C	
I <sub>DSS</sub>	Drain-to-Source Leakage Current	—	—	20	μA	V <sub>DS</sub> = 150V, V <sub>GS</sub> = 0V
		—	—	250		V <sub>DS</sub> = 150V, V <sub>GS</sub> = 0V, T <sub>J</sub> = 125°C
I <sub>GSS</sub>	Gate-to-Source Forward Leakage	—	—	100	nA	V <sub>GS</sub> = 20V
	Gate-to-Source Reverse Leakage	—	—	-100		V <sub>GS</sub> = -20V
g <sub>fs</sub>	Forward Transconductance	38	—	—	S	V <sub>DS</sub> = 50V, I <sub>D</sub> = 34A
Q <sub>g</sub>	Total Gate Charge	—	36	54	nC	V <sub>DS</sub> = 75V V <sub>GS</sub> = 10V I <sub>D</sub> = 34A
Q <sub>gs1</sub>	Pre-V <sub>th</sub> Gate-to-Source Charge	—	13	—		
Q <sub>gs2</sub>	Post-V <sub>th</sub> Gate-to-Source Charge	—	4.6	—		
Q <sub>gd</sub>	Gate-to-Drain Charge	—	11	—		
Q <sub>godr</sub>	Gate Charge Overdrive	—	7.4	—		
Q <sub>sw</sub>	Switch Charge (Q <sub>gs2</sub> + Q <sub>gd</sub> )	—	15.6	—		
Q <sub>oss</sub>	Output Charge	—	14	—	nC	V <sub>DS</sub> = 16V, V <sub>GS</sub> = 0V
R <sub>G</sub>	Gate Resistance	—	1.7	—	Ω	
t <sub>d(on)</sub>	Turn-On Delay Time	—	9.4	—	ns	V <sub>DD</sub> = 75V, V <sub>GS</sub> = 10V I <sub>D</sub> = 34A R <sub>G</sub> = 1.3Ω
t <sub>r</sub>	Rise Time	—	9.7	—		
t <sub>d(off)</sub>	Turn-Off Delay Time	—	14	—		
t <sub>f</sub>	Fall Time	—	3.4	—		
C <sub>iss</sub>	Input Capacitance	—	2300	—	pF	V <sub>GS</sub> = 0V V <sub>DS</sub> = 50V f = 1.0MHz
C <sub>oss</sub>	Output Capacitance	—	205	—		
C <sub>rss</sub>	Reverse Transfer Capacitance	—	47	—		

**Avalanche Characteristics**

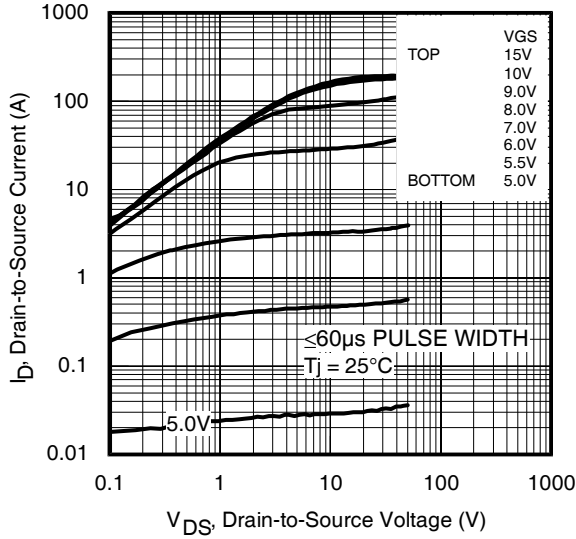
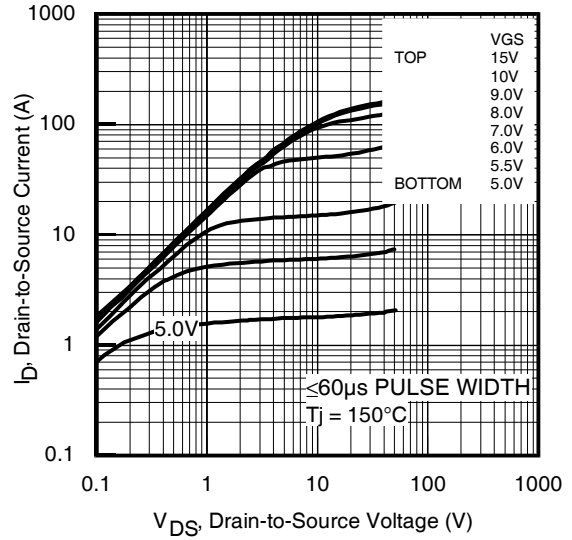
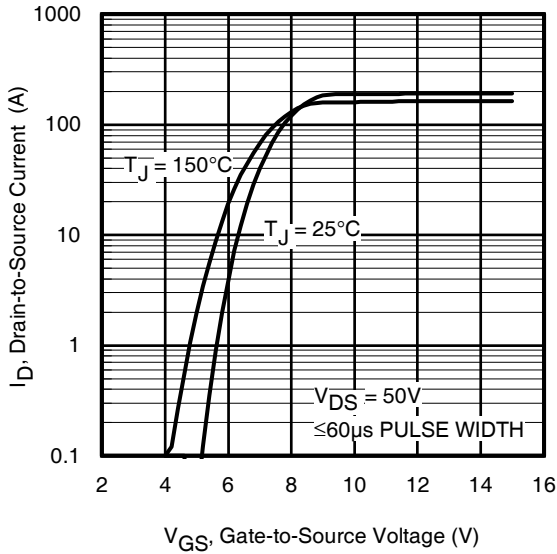
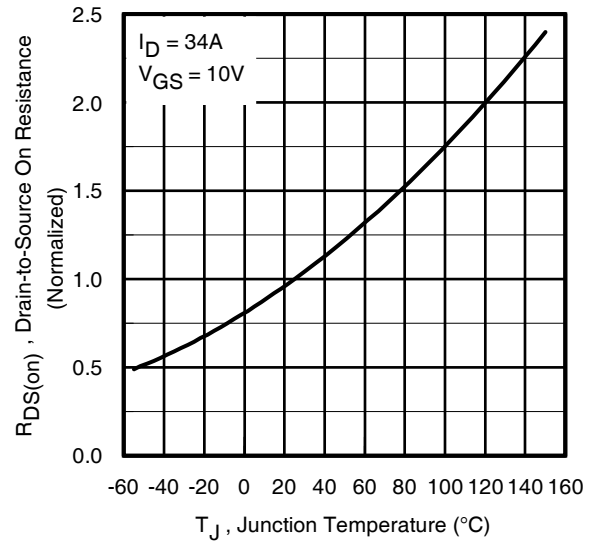
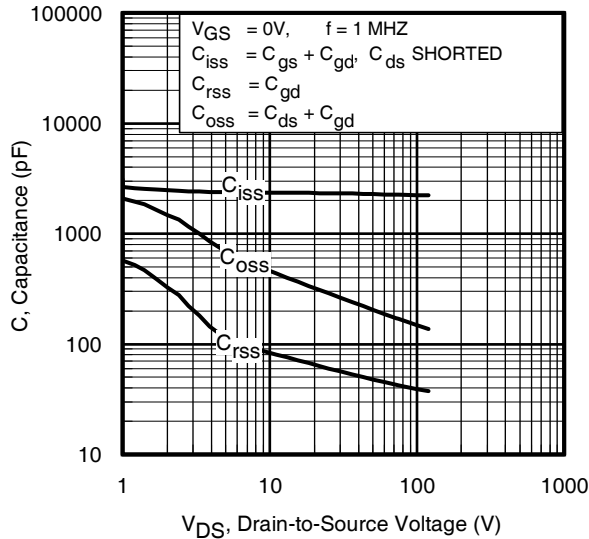
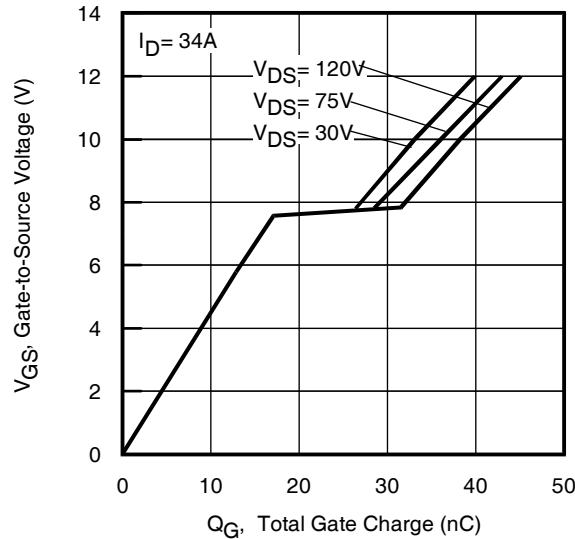
	Parameter	Typ.	Max.	Units
E <sub>AS</sub>	Single Pulse Avalanche Energy ②	—	230	mJ
I <sub>AR</sub>	Avalanche Current ①	—	34	A

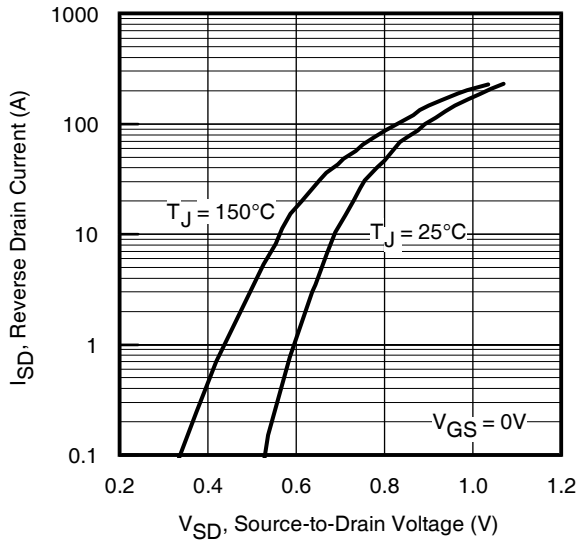
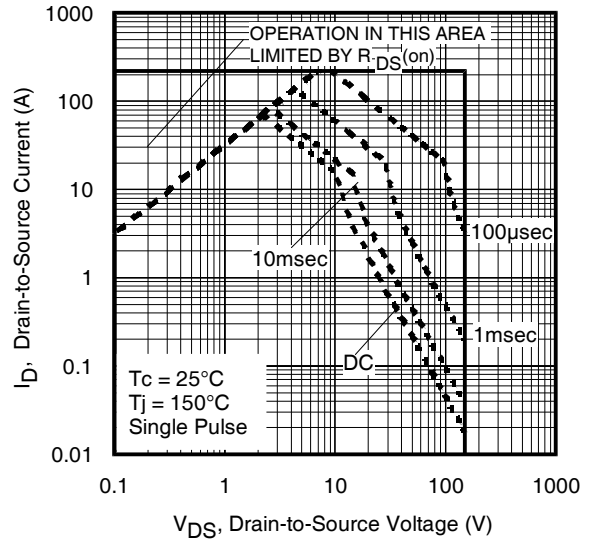
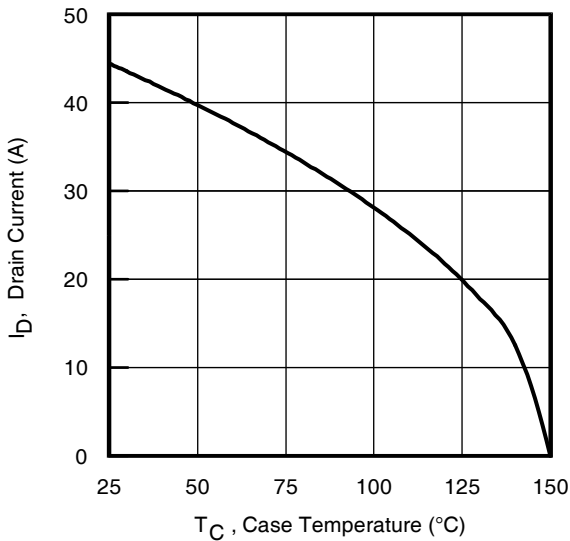
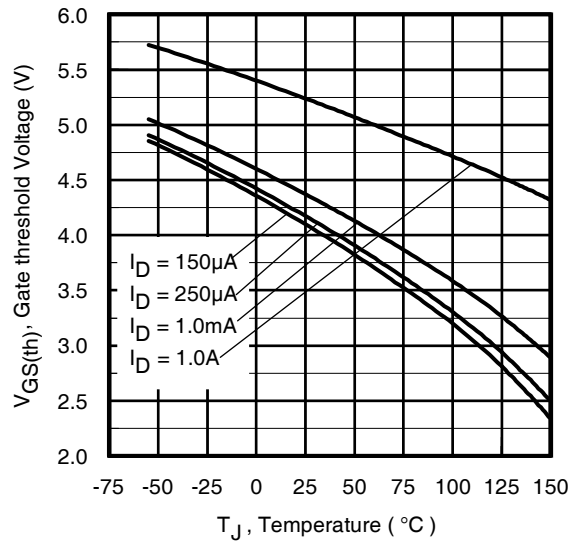
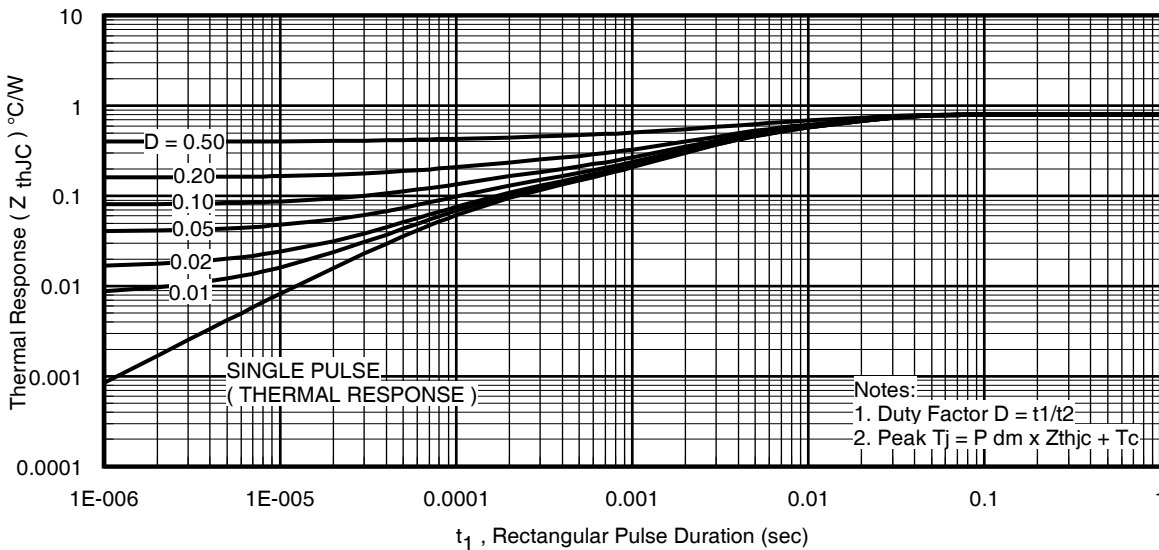
**Diode Characteristics**

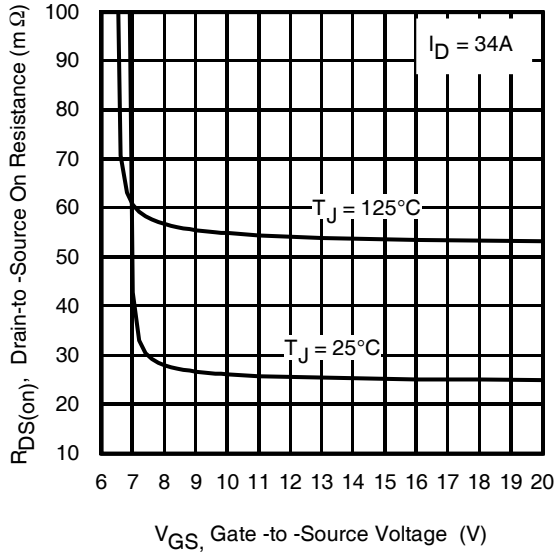
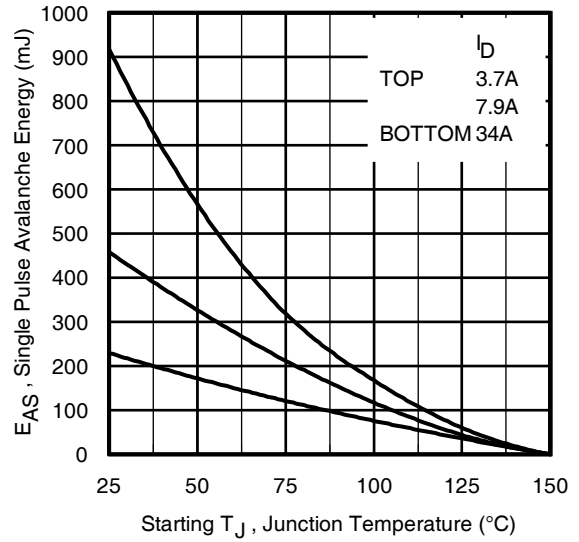
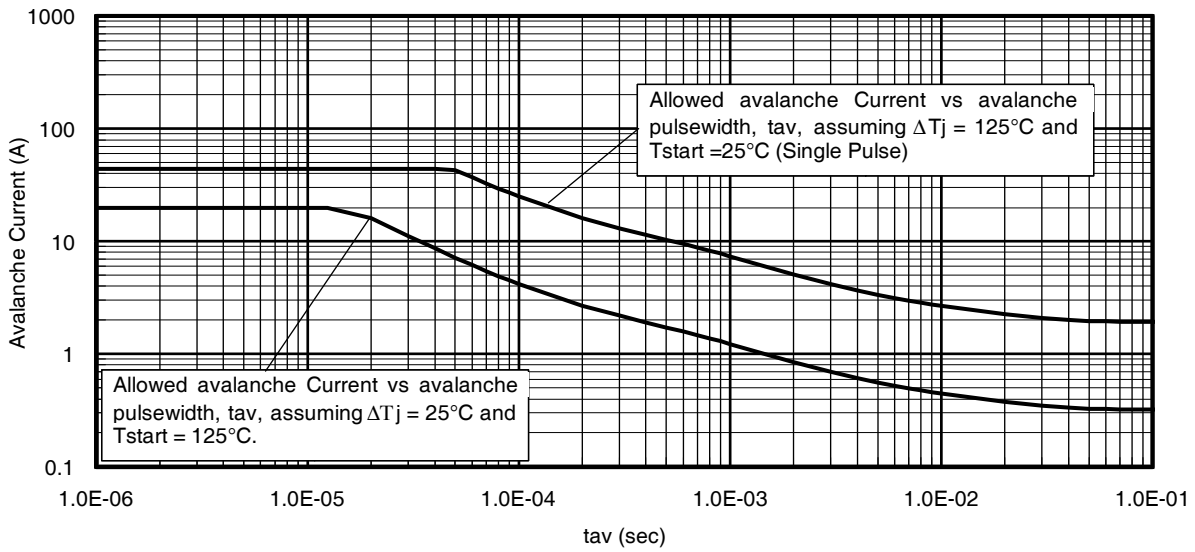
	Parameter	Min.	Typ.	Max.	Units	Conditions
I <sub>S</sub>	Continuous Source Current (Body Diode)	—	—	56	A	MOSFET symbol showing the integral reverse p-n junction diode. 
I <sub>SM</sub>	Pulsed Source Current (Body Diode) ①	—	—	220		
V <sub>SD</sub>	Diode Forward Voltage	—	—	1.3	V	T <sub>J</sub> = 25°C, I <sub>S</sub> = 34A, V <sub>GS</sub> = 0V ③
t <sub>rr</sub>	Reverse Recovery Time	—	52	78	ns	T <sub>J</sub> = 25°C, I <sub>F</sub> = 34A, V <sub>DD</sub> = 75V
Q <sub>rr</sub>	Reverse Recovery Charge	—	550	825	nC	di/dt = 500A/μs ③
t <sub>on</sub>	Forward Turn-On Time	Time is dominated by parasitic Inductance				

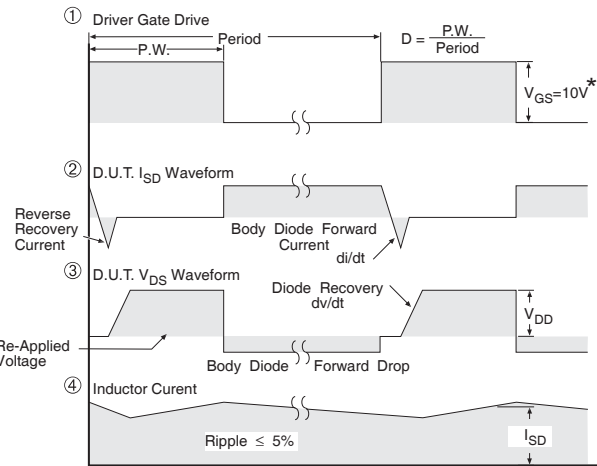
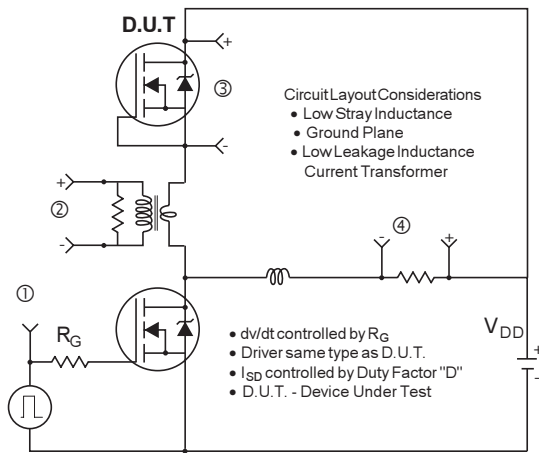
**Thermal Resistance**

	Parameter	Typ.	Max.	Units
R <sub>θJC-mb</sub>	Junction-to-Mounting Base	0.5	0.8	°C/W
R <sub>θJC</sub> (Top)	Junction-to-Case ④	—	15	
R <sub>θJA</sub>	Junction-to-Ambient ⑤	—	35	
R <sub>θJA</sub> (<10s)	Junction-to-Ambient ⑤	—	22	


**Fig 1.** Typical Output Characteristics

**Fig 2.** Typical Output Characteristics

**Fig 3.** Typical Transfer Characteristics

**Fig 4.** Normalized On-Resistance vs. Temperature

**Fig 5.** Typical Capacitance vs. Drain-to-Source Voltage

**Fig 6.** Typical Gate Charge vs. Gate-to-Source Voltage

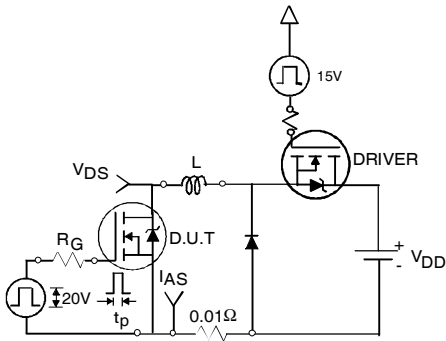

**Fig 7.** Typical Source-Drain Diode Forward Voltage

**Fig 8.** Maximum Safe Operating Area

**Fig 9.** Maximum Drain Current vs. Case Temperature

**Fig 10.** Threshold Voltage vs. Temperature

**Fig 11.** Maximum Effective Transient Thermal Impedance, Junction-to-Mounting Base


**Fig 12.** On-Resistance vs. Gate Voltage

**Fig 13.** Maximum Avalanche Energy vs. Drain Current

**Fig 14.** Typical Avalanche Current vs. Pulsewidth

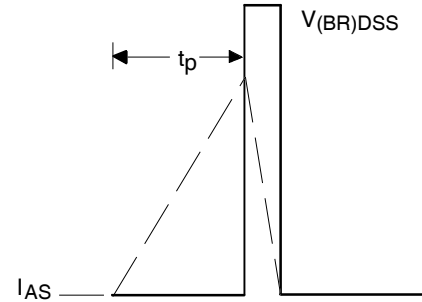


\*  $V_{GS} = 5V$  for Logic Level Devices

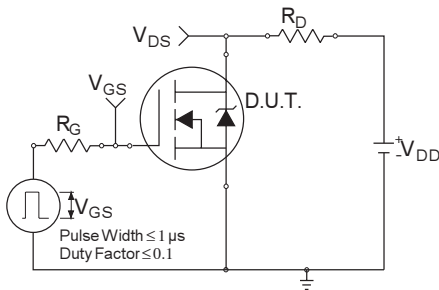
**Fig 15. Peak Diode Recovery  $dv/dt$  Test Circuit for N-Channel HEXFET® Power MOSFETs**



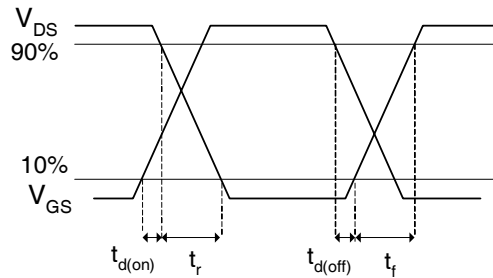
**Fig 16a. Unclamped Inductive Test Circuit**



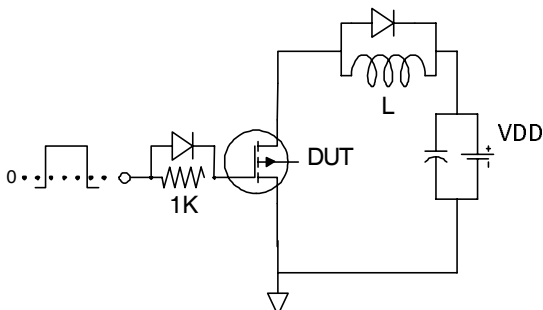
**Fig 16b. Unclamped Inductive Waveforms**



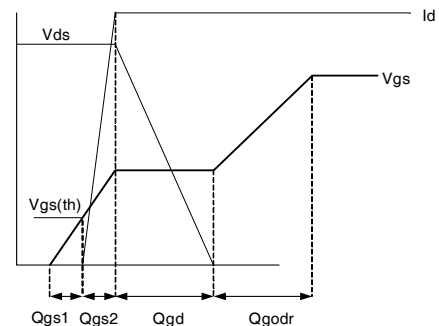
**Fig 17a. Switching Time Test Circuit**



**Fig 17b. Switching Time Waveforms**

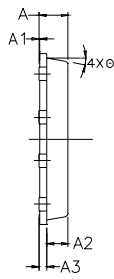


**Fig 18a. Gate Charge Test Circuit**

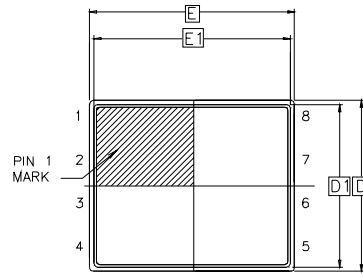


**Fig 18b. Gate Charge Waveform**

# PQFN 5x6 Outline "B" Package Details

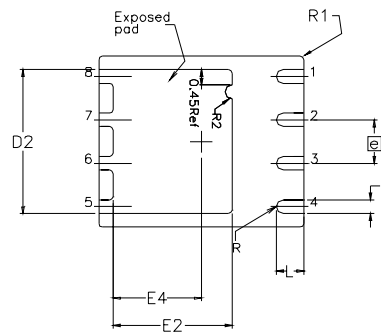


SIDE VIEW



TOP VIEW

SYMBOL	DIM	MIN	NOM	MAX
A		0.800	0.830	1.05
A1		0.000	0.020	0.050
A2		0.580	0.630	0.680
A3			0.254 REF	
Ø		0"	10"	12"
b		0.350	0.400	0.470
D		4.850	5.000	5.150
D1		4.675	4.750	5.000
D2		3.700	4.210	4.300
e			1.270 BSC	
E		5.850	6.000	6.150
E1		5.675	5.750	6.000
E2		3.380	3.480	3.760
E4		2.480	2.580	2.680
L		0.550	0.800	0.900
R			0.200 REF	
R1			0.100 REF	
R2		0.150	0.200	0.250



BOTTOM VIEW

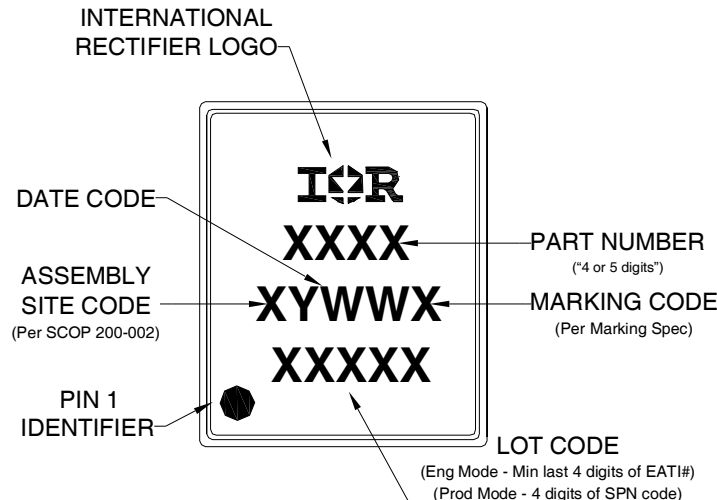
For more information on board mounting, including footprint and stencil recommendation, please refer to application note AN-1136:

<http://www.irf.com/technical-info/appnotes/an-1136.pdf>

For more information on package inspection techniques, please refer to application note AN-1154:

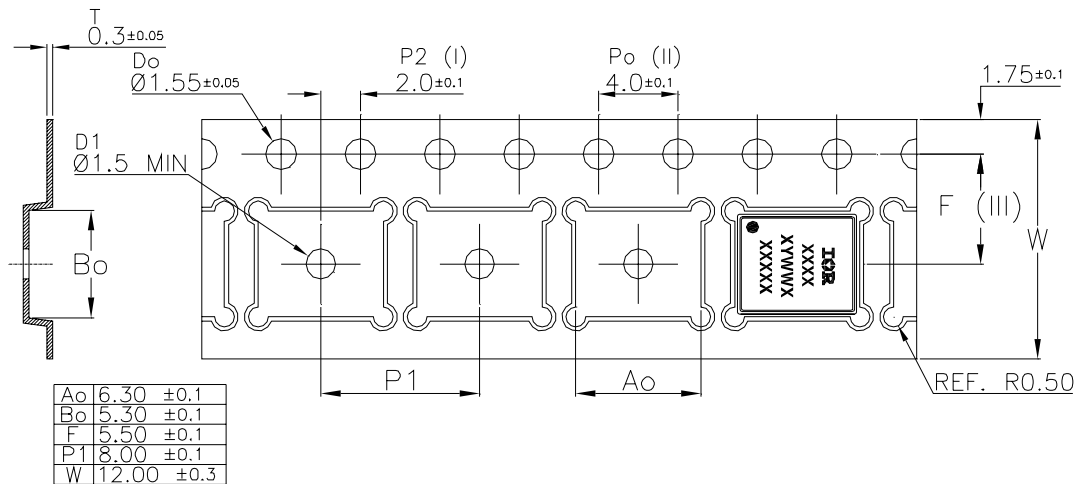
<http://www.irf.com/technical-info/appnotes/an-1154.pdf>

# PQFN 5x6 Outline "B" Part Marking



Note: For the most current drawing please refer to IR website at: <http://www.irf.com/package/>

## PQFN 5x6 Outline "B" Tape and Reel



### Qualification information<sup>†</sup>

Qualification level	Industrial <sup>††</sup> (per JEDEC JESD47F <sup>†††</sup> guidelines)	
Moisture Sensitivity Level	PQFN 5mm x 6mm	MSL1 (per JEDEC J-STD-020D <sup>†††</sup> )
RoHS compliant	Yes	

<sup>†</sup> Qualification standards can be found at International Rectifier's web site

<http://www.irf.com/product-info/reliability>

<sup>††</sup> Higher qualification ratings may be available should the user have such requirements. Please contact your International Rectifier sales representative for further information:

<http://www.irf.com/whoto-call/salesrep/>

<sup>†††</sup> Applicable version of JEDEC standard at the time of product release.

### Notes:

- ① Repetitive rating; pulse width limited by max. junction temperature.
- ② Starting  $T_J = 25^\circ\text{C}$ ,  $L = 0.41\text{mH}$ ,  $R_G = 25\Omega$ ,  $I_{AS} = 34\text{A}$ .
- ③ Pulse width  $\leq 400\mu\text{s}$ ; duty cycle  $\leq 2\%$ .
- ④  $R_\theta$  is measured at  $T_J$  of approximately  $90^\circ\text{C}$ .
- ⑤ When mounted on 1 inch square 2 oz copper pad on 1.5x1.5 in. board of FR-4 material.