

General Description

The MDIS3N40 uses advanced Magnachip's MOSFET Technology, which provides low on-state resistance, high switching performance and excellent quality. MDIS3N40 is suitable device for SMPS, HID and general purpose applications.

Features

- $V_{DS} = 400V$
 - $I_D = 2.0A$
 - $R_{DS(ON)} \leq 3.4\Omega$
- @ $V_{GS} = 10V$
@ $V_{GS} = 10V$

Applications

- Power Supply
- PFC
- LED TV

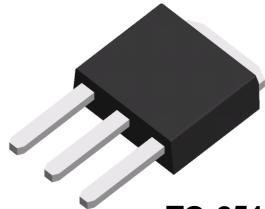

**TO-251-VS
(IPAK-VS)**

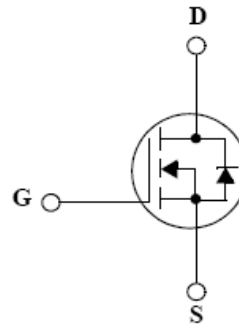

Absolute Maximum Ratings (Ta = 25°C)

| Characteristics | Symbol | Rating | Unit | |
|--|----------------|--------------------|------|------|
| Drain-Source Voltage | V_{DSS} | 400 | V | |
| Gate-Source Voltage | V_{GSS} | ±30 | V | |
| Continuous Drain Current | I_D | $T_C=25^\circ C$ | 2.0 | A |
| | | $T_C=100^\circ C$ | 1.2 | A |
| Pulsed Drain Current ⁽¹⁾ | I_{DM} | 8.0 | A | |
| Power Dissipation | P_D | $T_C=25^\circ C$ | 30 | W |
| | | Derate above 25 °C | 0.24 | W/°C |
| Peak Diode Recovery dv/dt ⁽³⁾ | dv/dt | 4.5 | V/ns | |
| Repetitive Pulse Avalanche Energy ⁽⁴⁾ | E_{AR} | 3.0 | mJ | |
| Avalanche current ⁽¹⁾ | I_{AR} | 2.0 | A | |
| Single Pulse Avalanche Energy ⁽⁴⁾ | E_{AS} | 45 | mJ | |
| Junction and Storage Temperature Range | T_J, T_{stg} | -55~150 | °C | |

Thermal Characteristics

| Characteristics | Symbol | Rating | Unit |
|--|-----------------|--------|------|
| Thermal Resistance, Junction-to-Ambient ⁽¹⁾ | $R_{\theta JA}$ | 110 | °C/W |
| Thermal Resistance, Junction-to-Case ⁽¹⁾ | $R_{\theta JC}$ | 4.1 | |

Ordering Information

| Part Number | Temp. Range | Package | Packing | RoHS Status |
|-------------|-------------|---------------------|---------|--------------|
| MDIS3N40TH | -55~150°C | TO-251-VS (IPAK-VS) | Tube | Halogen Free |

Electrical Characteristics (Ta =25°C)

| Characteristics | Symbol | Test Condition | Min | Typ | Max | Unit |
|--|--------------|---|-----|-----|-----|----------|
| Static Characteristics | | | | | | |
| Drain-Source Breakdown Voltage | BV_{DSS} | $I_D = 250\mu A, V_{GS} = 0V$ | 400 | - | - | V |
| Gate Threshold Voltage | $V_{GS(th)}$ | $V_{DS} = V_{GS}, I_D = 250\mu A$ | 3.0 | - | 5.0 | |
| Drain Cut-Off Current | I_{DSS} | $V_{DS} = 400V, V_{GS} = 0V$ | - | - | 1 | μA |
| Gate Leakage Current | I_{GSS} | $V_{GS} = \pm 30V, V_{DS} = 0V$ | - | - | 100 | nA |
| Drain-Source ON Resistance | $R_{DS(ON)}$ | $V_{GS} = 10V, I_D = 1.0A$ | - | 2.8 | 3.4 | Ω |
| Forward Transconductance | g_{fs} | $V_{DS} = 30V, I_D = 1.0A$ | - | 2.0 | - | S |
| Dynamic Characteristics | | | | | | |
| Total Gate Charge | Q_g | $V_{DS} = 320V, I_D = 3.0A, V_{GS} = 10V^{(3)}$ | - | 5.1 | - | nC |
| Gate-Source Charge | Q_{gs} | | - | 1.4 | - | |
| Gate-Drain Charge | Q_{gd} | | - | 3.9 | - | |
| Input Capacitance | C_{iss} | $V_{DS} = 25V, V_{GS} = 0V, f = 1.0MHz$ | - | 167 | - | pF |
| Reverse Transfer Capacitance | C_{rss} | | - | 2 | - | |
| Output Capacitance | C_{oss} | | - | 27 | - | |
| Turn-On Delay Time | $t_{d(on)}$ | $V_{GS} = 10V, V_{DS} = 200V, I_D = 3.0A, R_G = 25\Omega$ | - | 10 | - | ns |
| Rise Time | t_r | | - | 30 | - | |
| Turn-Off Delay Time | $t_{d(off)}$ | | - | 12 | - | |
| Fall Time | t_f | | - | 25 | - | |
| Drain-Source Body Diode Characteristics | | | | | | |
| Maximum Continuous Drain to Source Diode Forward Current | I_S | | - | 0.5 | - | A |
| Source-Drain Diode Forward Voltage | V_{SD} | $I_S = 3.0A, V_{GS} = 0V$ | - | - | 1.4 | V |
| Body Diode Reverse Recovery Time | t_{rr} | $I_F = 3.0A, di/dt = 100A/\mu s$ | - | 185 | - | ns |
| Body Diode Reverse Recovery Charge | Q_{rr} | | - | 0.6 | - | μC |

Note :

- Pulse width is based on $R_{\theta JC}$ & $R_{\theta JA}$ and the maximum allowed junction temperature of 150°C.
- Pulse test: pulse width $\leq 300\mu s$, duty cycle $\leq 2\%$, pulse width limited by junction temperature $T_{J(MAX)}=150^\circ C$.
- $I_{SD} \leq 3.0A$, $di/dt \leq 200A/\mu s$, $V_{DD}=50V$, $R_g = 25\Omega$, Starting $T_J=25^\circ C$
- $L=9.2mH$, $I_{AS}=3.0A$, $V_{DD}=50V$, $R_g = 25\Omega$, Starting $T_J=25^\circ C$

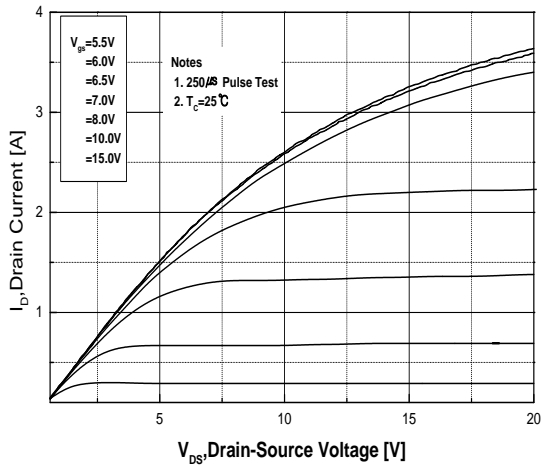

Fig.1 On-Region Characteristics

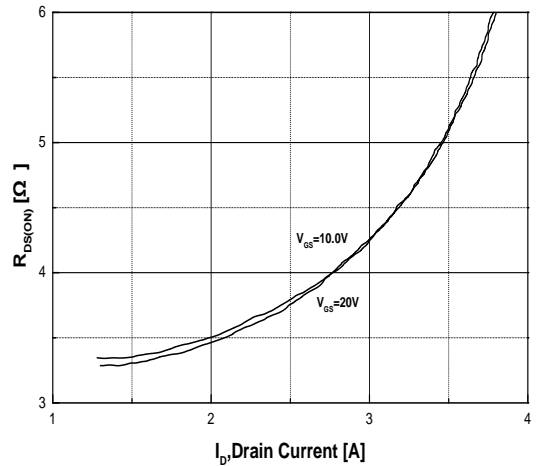

Fig.2 On-Resistance Variation with Drain Current and Gate Voltage

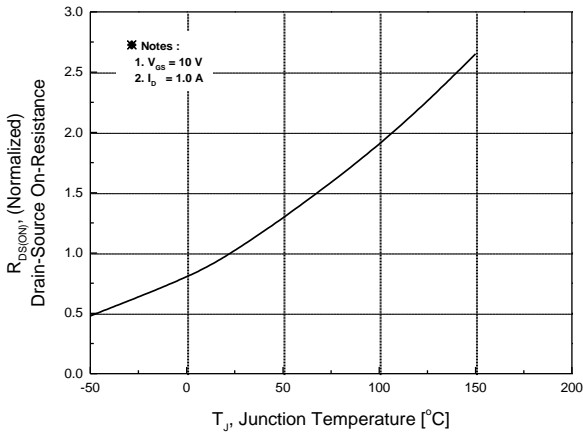

Fig.3 On-Resistance Variation with Temperature

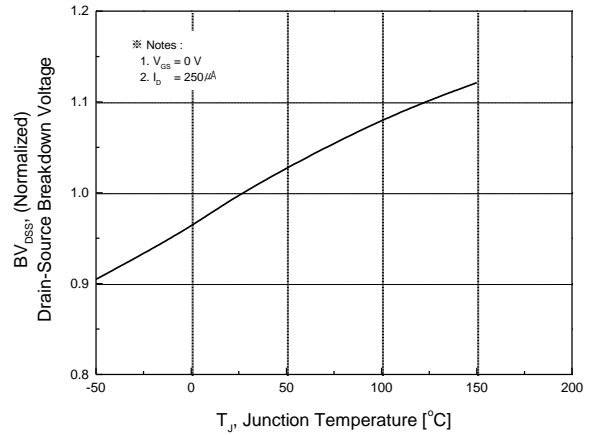

Fig.4 Breakdown Voltage Variation vs. Temperature

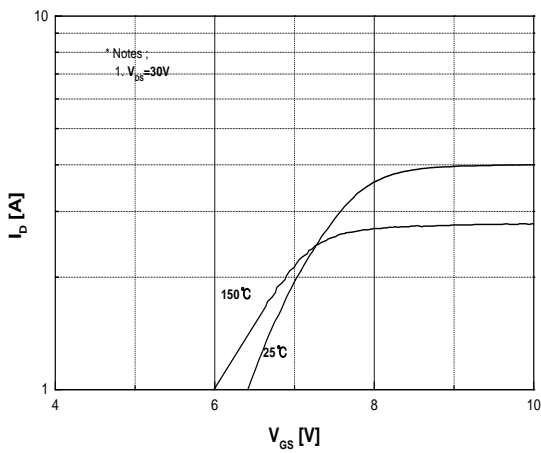

Fig.5 Transfer Characteristics

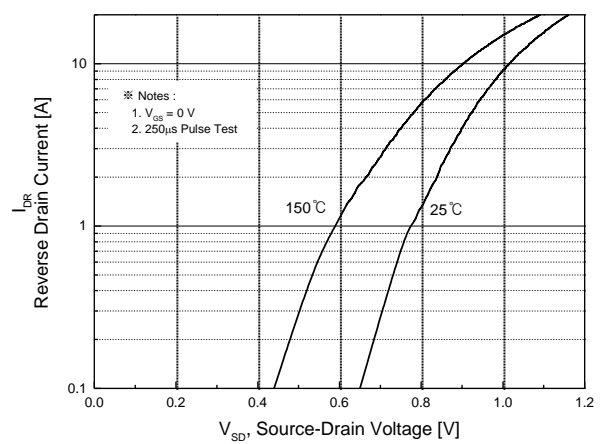

Fig.6 Body Diode Forward Voltage Variation with Source Current and Temperature

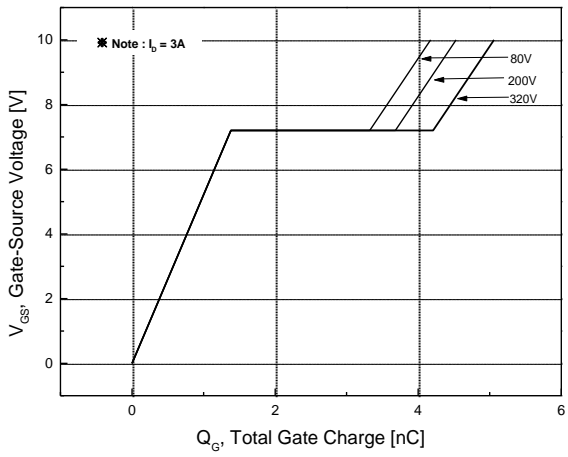

Fig.7 Gate Charge Characteristics

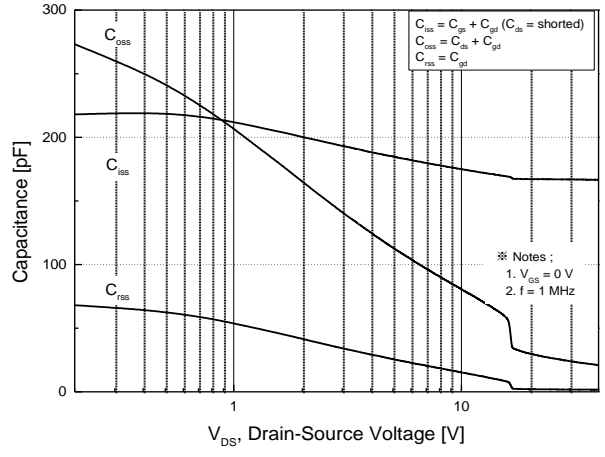

Fig.8 Capacitance Characteristics

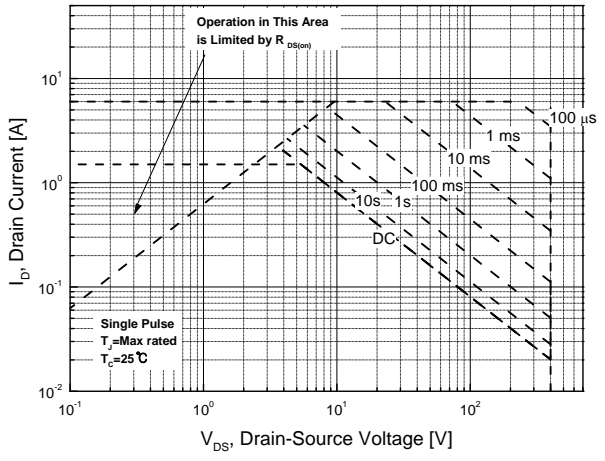

Fig.9 Maximum Safe Operating Area

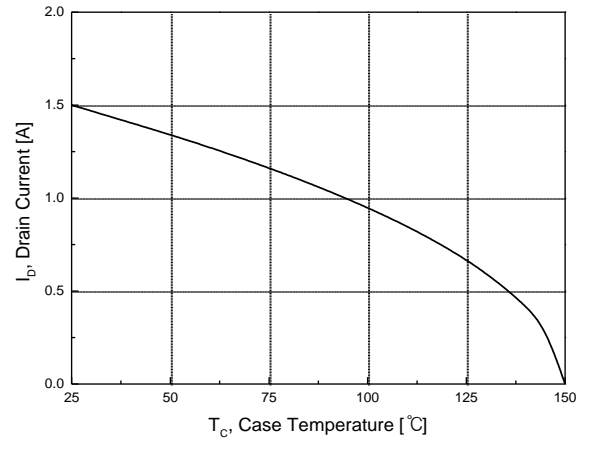

Fig.10 Maximum Drain Current vs. Case Temperature

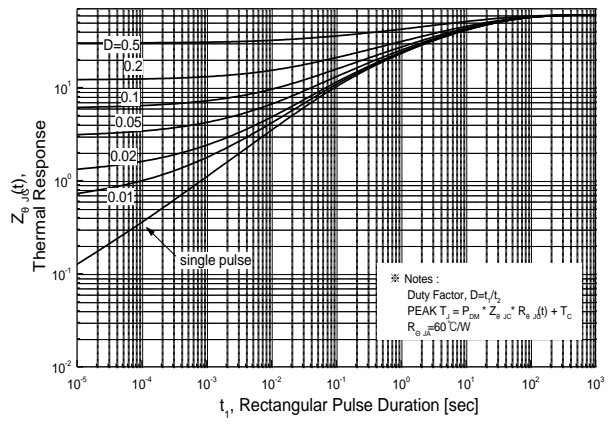

Fig.11 Transient Thermal Response Curve

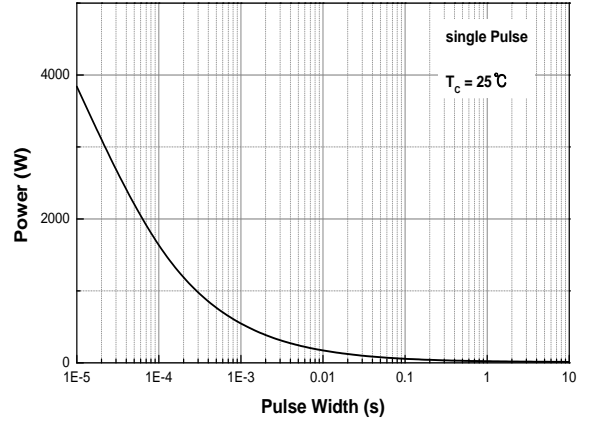
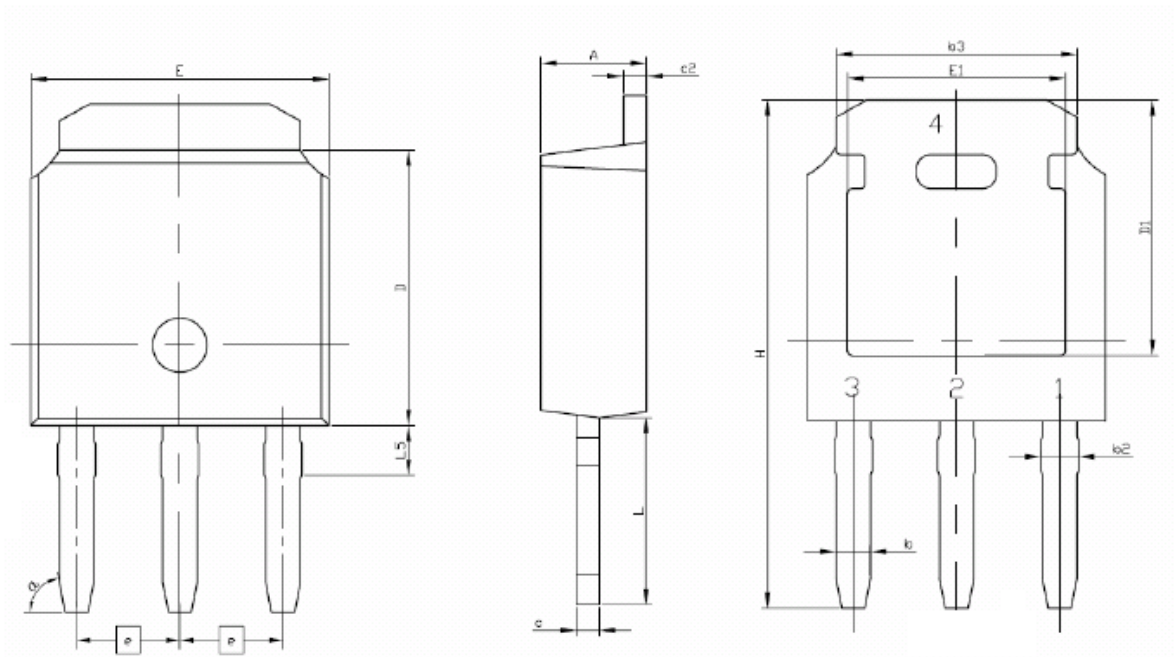

Fig.12 Single Pulse Maximum Power Dissipation

Physical Dimension

TO-251-VS (IPAK-VS)

Dimensions are in millimeters, unless otherwise specified



| Symbol | MILLIMETERS | |
|--------|-------------|---------|
| | Minimum | Maximum |
| A | 2.18 | 2.39 |
| b | 0.64 | 0.89 |
| b2 | 0.76 | 1.14 |
| b3 | 4.95 | 5.46 |
| c | 0.40 | 0.61 |
| c2 | 0.40 | 0.61 |
| D | 5.97 | 6.223 |
| D1 | 5.10 | - |
| e | 2.286 BSC | |
| E | 6.35 | 6.73 |
| E1 | 4.32 | - |
| H | 10.26 | 11.45 |
| L | 3.98 | 4.28 |
| L5 | - | 1.23 |

DISCLAIMER:

The Products are not designed for use in hostile environments, including, without limitation, aircraft, nuclear power generation, medical appliances, and devices or systems in which malfunction of any Product can reasonably be expected to result in a personal injury. Seller's customers using or selling Seller's products for use in such applications do so at their own risk and agree to fully defend and indemnify Seller.

MagnaChip reserves the right to change the specifications and circuitry without notice at any time. MagnaChip does not consider responsibility for use of any circuitry other than circuitry entirely included in a MagnaChip product.  is a registered trademark of MagnaChip Semiconductor Ltd.