

General Description

The MDI6N60B uses advanced MagnaChip's MOSFET Technology, which provides low on-state resistance, high switching performance and excellent quality.

MDI6N60B is suitable device for SMPS, high Speed switching and general purpose applications.

Features

- $V_{DS} = 600V$
- $I_D = 4.5A$ @ $V_{GS} = 10V$
- $R_{DS(ON)} \leq 1.45\Omega$ @ $V_{GS} = 10V$

Applications

- Power Supply
- PFC
- Ballast

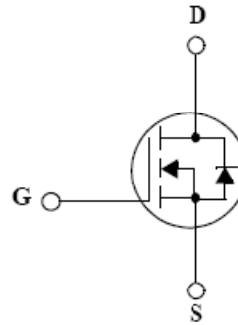

Absolute Maximum Ratings (Ta = 25°C)

| Characteristics | Symbol | Rating | Unit | |
|--|----------------|--------------------|------|------|
| Drain-Source Voltage | V_{DSS} | 600 | V | |
| Gate-Source Voltage | V_{GSS} | ±30 | V | |
| Continuous Drain Current | I_D | $T_C=25^\circ C$ | 4.5* | A |
| | | $T_C=100^\circ C$ | 2.8* | A |
| Pulsed Drain Current ⁽¹⁾ | I_{DM} | 18* | A | |
| Power Dissipation | P_D | $T_C=25^\circ C$ | 73 | W |
| | | Derate above 25 °C | 0.59 | W/°C |
| Repetitive Avalanche Energy ⁽¹⁾ | E_{AR} | 7.3 | mJ | |
| Peak Diode Recovery dv/dt ⁽³⁾ | dv/dt | 4.5 | V/ns | |
| Single Pulse Avalanche Energy ⁽⁴⁾ | E_{AS} | 140 | mJ | |
| Junction and Storage Temperature Range | T_J, T_{stg} | -55~150 | °C | |

※ I_D limited by maximum junction temperature

Thermal Characteristics

| Characteristics | Symbol | Rating | Unit |
|--|-----------------|--------|------|
| Thermal Resistance, Junction-to-Ambient ⁽¹⁾ | $R_{\theta JA}$ | 110 | °C/W |
| Thermal Resistance, Junction-to-Case ⁽¹⁾ | $R_{\theta JC}$ | 1.7 | |

Ordering Information

| Part Number | Temp. Range | Package | Packing | RoHS Status |
|-------------|-------------|---------|---------|--------------|
| MDI6N60BTH | -55~150°C | I-PAK | Tube | Halogen Free |

Electrical Characteristics (Ta =25°C)

| Characteristics | Symbol | Test Condition | Min | Typ | Max | Unit |
|--|--------------|---|-----|------|------|----------|
| Static Characteristics | | | | | | |
| Drain-Source Breakdown Voltage | BV_{DSS} | $I_D = 250\mu A, V_{GS} = 0V$ | 600 | - | - | V |
| Gate Threshold Voltage | $V_{GS(th)}$ | $V_{DS} = V_{GS}, I_D = 250\mu A$ | 2.0 | - | 4.0 | |
| Drain Cut-Off Current | I_{DSS} | $V_{DS} = 600V, V_{GS} = 0V$ | - | - | 1 | μA |
| Gate Leakage Current | I_{GSS} | $V_{GS} = \pm 30V, V_{DS} = 0V$ | - | - | 100 | nA |
| Drain-Source ON Resistance | $R_{DS(ON)}$ | $V_{GS} = 10V, I_D = 2.25A$ | - | 1.2 | 1.45 | Ω |
| Forward Transconductance | g_{fs} | $V_{DS} = 30V, I_D = 2.25A$ | - | 5 | - | S |
| Dynamic Characteristics | | | | | | |
| Total Gate Charge | Q_g | $V_{DS} = 480V, I_D = 6.0A, V_{GS} = 10V^{(3)}$ | - | 13.6 | - | nC |
| Gate-Source Charge | Q_{gs} | | - | 2.5 | - | |
| Gate-Drain Charge | Q_{gd} | | - | 4.5 | - | |
| Input Capacitance | C_{iss} | $V_{DS} = 25V, V_{GS} = 0V, f = 1.0MHz$ | - | 684 | - | pF |
| Reverse Transfer Capacitance | C_{rss} | | - | 3.4 | - | |
| Output Capacitance | C_{oss} | | - | 77 | - | |
| Turn-On Delay Time | $t_{d(on)}$ | $V_{GS} = 10V, V_{DS} = 250V, I_D = 6.0A, R_G = 25\Omega^{(3)}$ | - | 14.3 | - | ns |
| Rise Time | t_r | | - | 18.2 | - | |
| Turn-Off Delay Time | $t_{d(off)}$ | | - | 50.6 | - | |
| Fall Time | t_f | | - | 24.5 | - | |
| Drain-Source Body Diode Characteristics | | | | | | |
| Maximum Continuous Drain to Source Diode Forward Current | I_S | | - | 6 | - | A |
| Source-Drain Diode Forward Voltage | V_{SD} | $I_S = 6.0A, V_{GS} = 0V$ | - | | 1.4 | V |
| Body Diode Reverse Recovery Time | t_{rr} | $I_F = 6.0A, di/dt = 100A/\mu s^{(3)}$ | - | 275 | - | ns |
| Body Diode Reverse Recovery Charge | Q_{rr} | | - | 2.1 | - | μC |

Note :

- Pulse width is based on $R_{\theta JC}$ & $R_{\theta JA}$ and the maximum allowed junction temperature of 150°C.
- Pulse test: pulse width $\leq 300\mu s$, duty cycle $\leq 2\%$, pulse width limited by junction temperature $T_{J(MAX)}=150^\circ C$.
- $I_{SD} \leq 6.0A, di/dt \leq 200A/\mu s, V_{DD} \leq BV_{DSS}, R_g = 25\Omega$, Starting $T_J = 25^\circ C$
- $L = 7.2mH, I_{AS} = 6.0A, V_{DD} = 50V, R_g = 25\Omega$, Starting $T_J = 25^\circ C$

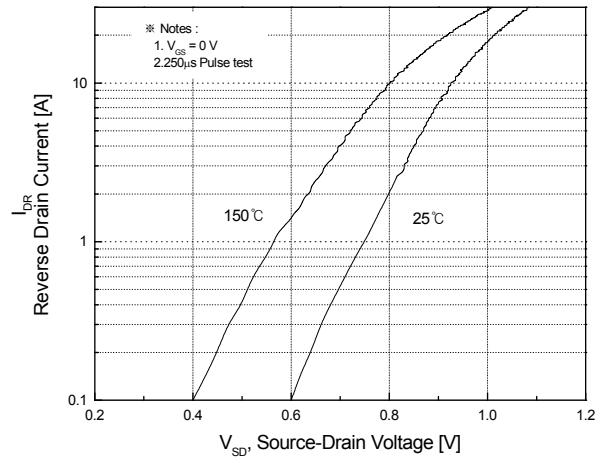
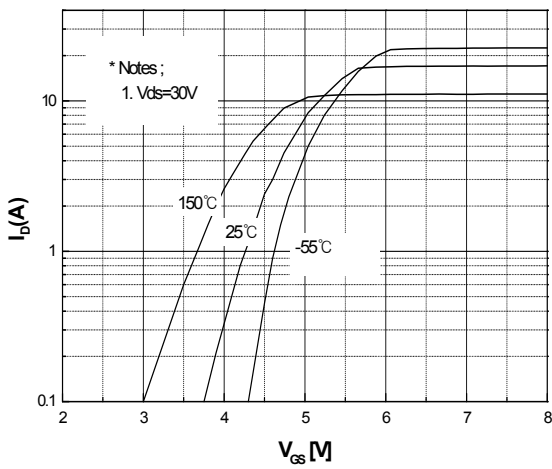
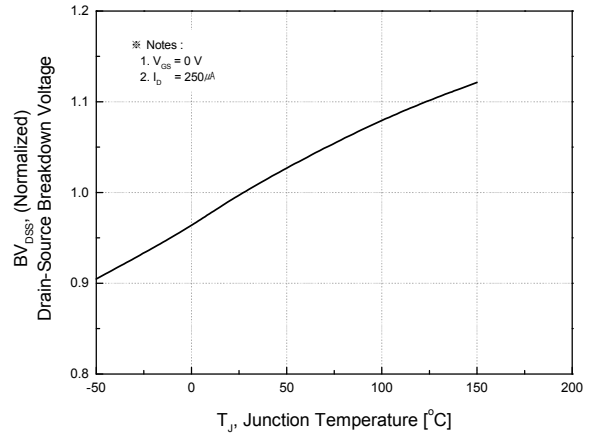
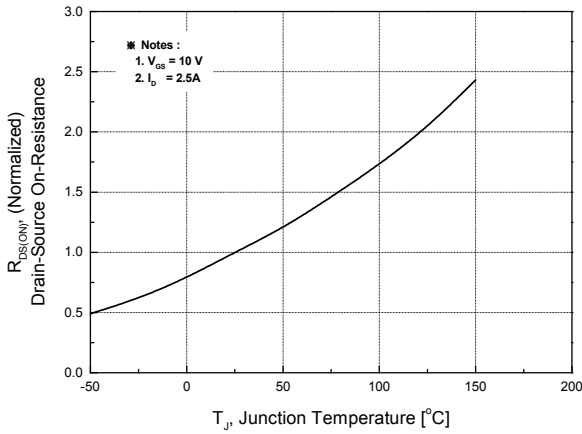
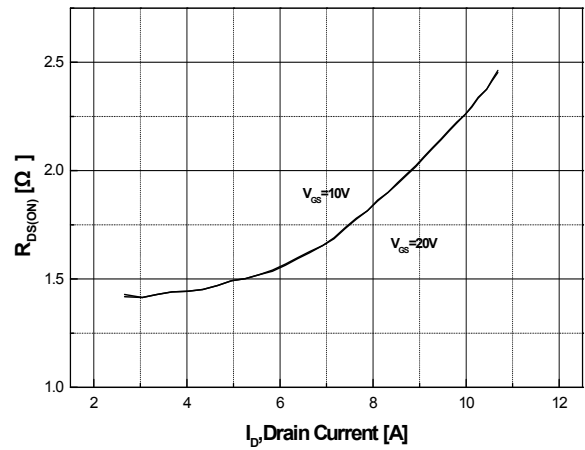
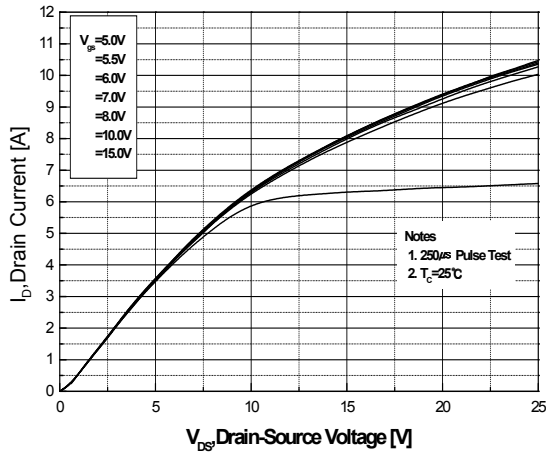

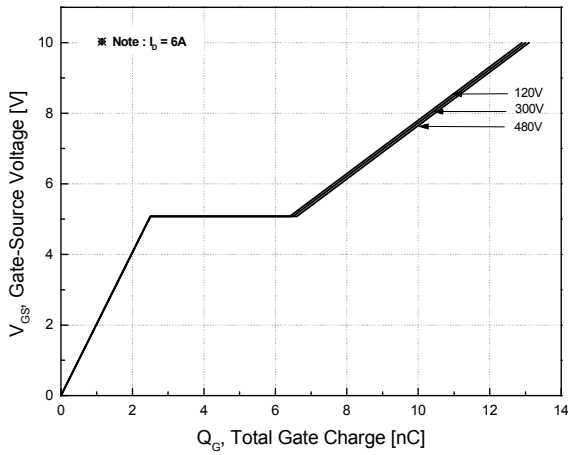

Fig.7 Gate Charge Characteristics

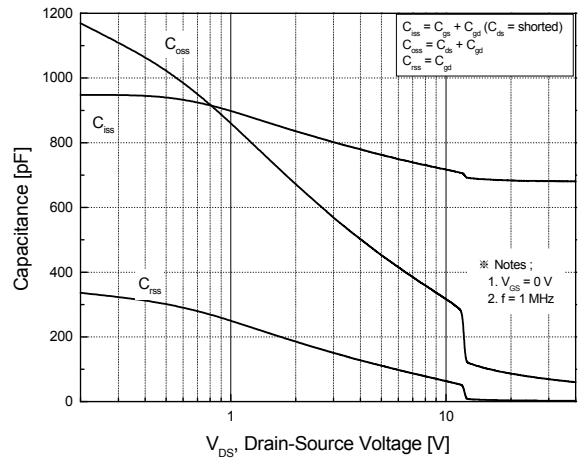

Fig.8 Capacitance Characteristics

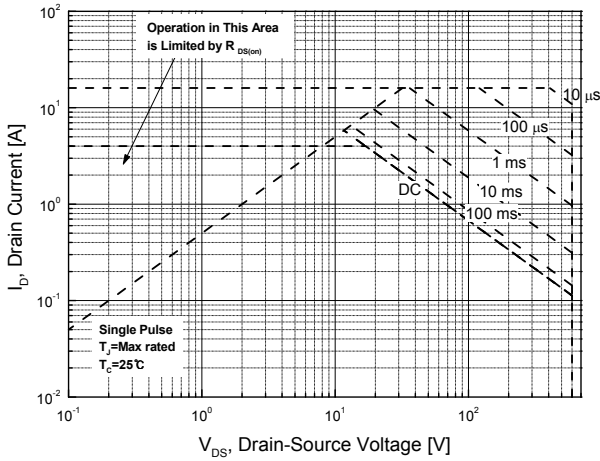

Fig.9 Maximum Safe Operating Area

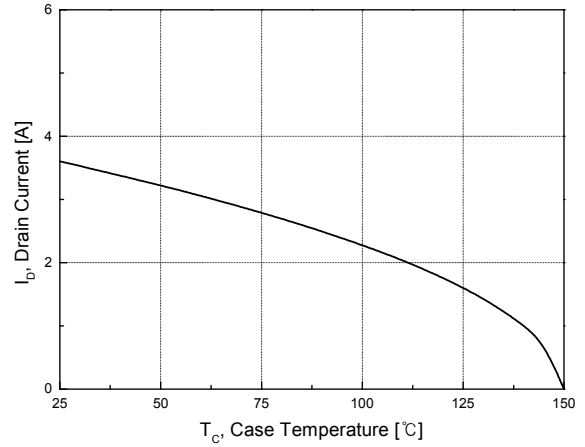

Fig.10 Maximum Drain Current vs. Case Temperature

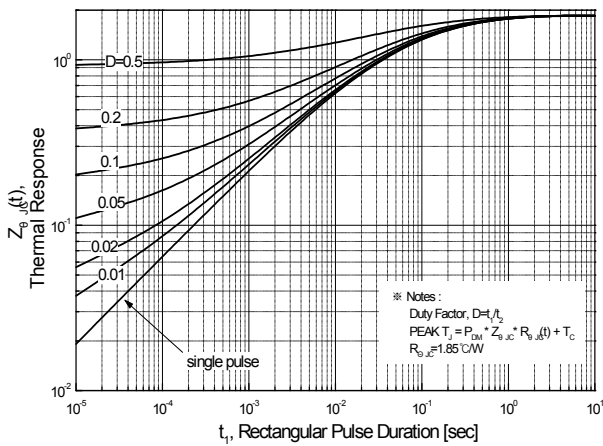

Fig.11 Transient Thermal Response Curve

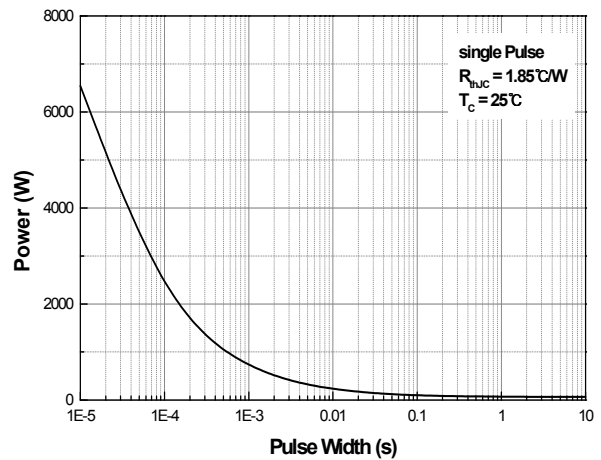
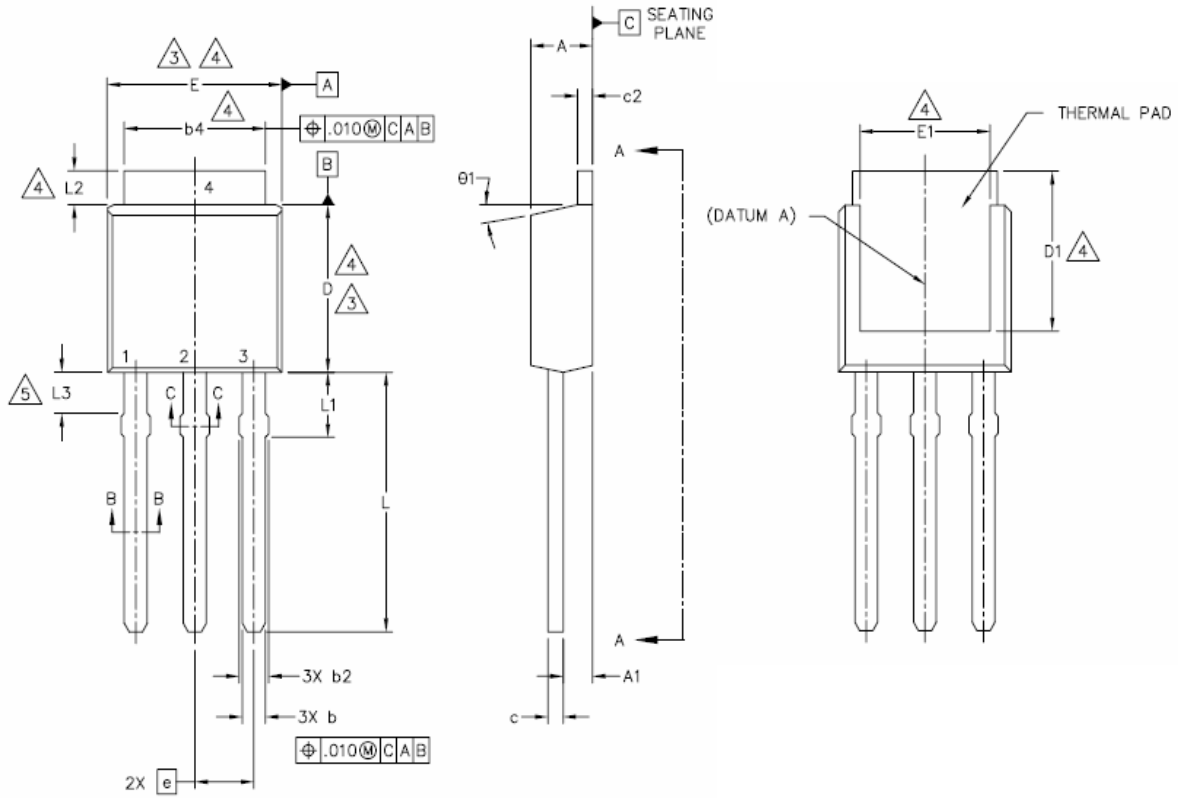

Fig.12 Single Pulse Maximum Power Dissipation

Physical Dimension

TO-251 (IPAK)

Dimensions are in millimeters unless otherwise specified



| SYMBOL | MIN | NOM | MAX |
|--------|----------|------|------|
| A | 2.18 | - | 2.39 |
| A1 | 0.89 | - | 1.14 |
| b | 0.64 | - | 0.89 |
| b1 | 0.64 | 0.71 | 0.79 |
| b2 | 0.76 | - | 1.14 |
| b4 | 4.95 | - | 5.46 |
| c | 0.46 | - | 0.61 |
| c2 | 0.46 | - | 0.89 |
| D | 5.97 | 6.10 | 6.22 |
| D1 | 4.75 | - | |
| E | 6.35 | - | 6.73 |
| E1 | 4.32 | - | 0.00 |
| e | 2.30 BSC | | |
| L | 8.89 | - | 9.65 |
| L1 | 1.80 | - | 2.29 |
| L2 | 0.70 | - | 1.27 |
| L3 | 1.14 | - | 1.52 |

Worldwide Sales Support Locations

U.S.A

Sunnyvale Office

787 N. Mary Ave. Sunnyvale
CA 94085 U.S.A
Tel : 1-408-636-5200
Fax : 1-408-213-2450
E-Mail : usasales@magnachip.com

U.K

Knyvett House The Causeway,
Staines Middx, TW18 3BA,U.K.
Tel : +44 (0) 1784-895-000
Fax : +44 (0) 1784-895-115
E-Mail : uksales@magnachip.com

Japan

Osaka Office

3F, Shin-Osaka MT-2 Bldg 3-5-36
Miyahara Yodogawa-Ku
Osaka, 532-0003 Japan
Tel : 81-6-6394-9160
Fax : 81-6-6394-9150
E-Mail : osakasales@magnachip.com

Taiwan R.O.C

2F, No.61, Chowize Street, Nei Hu
Taipei, 114 Taiwan R.O.C
Tel : 886-2-2657-7898
Fax : 886-2-2657-8751
E-Mail : taiwansales@magnachip.com

China

Hong Kong Office

Suite 1024, Ocean Centre 5 Canton Road,
Tsim Sha Tsui Kowloon, Hong Kong
Tel : 852-2828-9700
Fax : 852-2802-8183
E-Mail : chinasales@magnachip.com

Shenzhen Office

Room 2003B, 20/F
International Chamber of Commerce Tower
Fuhua Road3 CBD, Futian District, China
Tel : 86-755-8831-5561
Fax : 86-755-8831-5565
E-Mail : chinasales@magnachip.com

Shanghai Office

Room E, 8/F, Liaoshen International Building 1068
Wuzhong Road, (C) 201103
Shanghai, China
Tel : 86-21-6405-1521
Fax : 86-21-6505-1523
E-Mail : chinasales@magnachip.com

Korea

891, Daechi-Dong, Kangnam-Gu
Seoul, 135-738 Korea
Tel : 82-2-6903-3451
Fax : 82-2-6903-3668 ~9
Email : koreasales@magnachip.com

DISCLAIMER:

The Products are not designed for use in hostile environments, including, without limitation, aircraft, nuclear power generation, medical appliances, and devices or systems in which malfunction of any Product can reasonably be expected to result in a personal injury. Seller's customers using or selling Seller's products for use in such applications do so at their own risk and agree to fully defend and indemnify Seller.

MagnaChip reserves the right to change the specifications and circuitry without notice at any time. MagnaChip does not consider responsibility for use of any circuitry other than circuitry entirely included in a MagnaChip product. [MagnaChip](#) is a registered trademark of MagnaChip Semiconductor Ltd.