

### General Description

The MDD1951 uses advanced MagnaChip's trench MOSFET Technology to provide high performance in on-state resistance, switching performance and reliability. Low  $R_{DS(ON)}$ , low gate charge can be offering superior benefit in the application.

### Features

- $V_{DS} = 60V$
- $I_D = 17.9A @ V_{GS} = 10V$
- $R_{DS(ON)} < 45.0m\Omega @ V_{GS} = 10V$   
 $< 55.0m\Omega @ V_{GS} = 4.5V$

### Applications

- Inverters
- General purpose applications

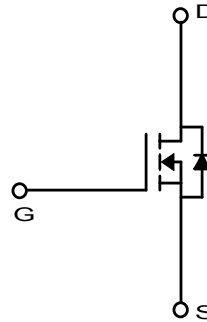
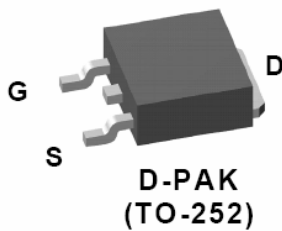

### Absolute Maximum Ratings ( $T_C = 25^\circ C$ unless otherwise noted)

Characteristics		Symbol	Rating	Unit
Drain-Source Voltage		$V_{DSS}$	60	V
Gate-Source Voltage		$V_{GSS}$	$\pm 20$	V
Continuous Drain Current	$T_C = 25^\circ C$ (a)	$I_D$	17.9	A
	$T_A = 25^\circ C$ (b)		4.4	A
Pulsed Drain Current		$I_{DM}$	80	A
Power Dissipation for Single Operation	$T_C = 25^\circ C$	$P_D$	32.8	W
	$T_A = 25^\circ C$		2.0	
Single Pulse Avalanche Energy (Note 3)		$E_{AS}$	50	mJ
Junction and Storage Temperature Range		$T_J, T_{stg}$	-55~+150	$^\circ C$

### Thermal Characteristics

Characteristics		Symbol	Rating	Unit
Thermal Resistance, Junction-to-Ambient(Steady-State)	(Note 1)	$R_{\theta JA}$	60	$^\circ C/W$
Thermal Resistance, Junction-to-Case		$R_{\theta JC}$	3.8	

## Ordering Information

Part Number	Temp. Range	Package	Packing	RoHS Status
MDD1951RH	-55~150°C	TO-252	Tape & Reel	Halogen Free

## Electrical Characteristics (T<sub>J</sub> =25°C unless otherwise noted)

Characteristics	Symbol	Test Condition	Min	Typ	Max	Unit
<b>Static Characteristics</b>						
Drain-Source Breakdown Voltage	BV <sub>DSS</sub>	I <sub>D</sub> = 250μA, V <sub>GS</sub> = 0V	60	-	-	V
Gate Threshold Voltage	V <sub>GS(th)</sub>	V <sub>DS</sub> = V <sub>GS</sub> , I <sub>D</sub> = 250μA	1.0	2.0	3.0	
Zero Gate Voltage Drain Current	I <sub>DSS</sub>	V <sub>DS</sub> = 60V, V <sub>GS</sub> = 0V	-	-	1	μA
Gate Leakage Current	I <sub>GSS</sub>	V <sub>GS</sub> = ±20V, V <sub>DS</sub> = 0V	-	-	0.1	
Drain-Source ON Resistance	R <sub>DS(ON)</sub>	V <sub>GS</sub> = 10V, I <sub>D</sub> = 17A	-	36	45	mΩ
		V <sub>GS</sub> = 4.5V, I <sub>D</sub> = 12A	-	44	55	
Forward Transconductance	g <sub>FS</sub>	V <sub>DS</sub> = 5V, I <sub>D</sub> = 17A	-	26	-	S
<b>Dynamic Characteristics</b>						
Total Gate Charge	Q <sub>g</sub>	V <sub>DS</sub> = 30V, I <sub>D</sub> = 17A, V <sub>GS</sub> = 4.5V	-	4.8	-	nC
Gate-Source Charge	Q <sub>gs</sub>		-	1.6	-	
Gate-Drain Charge	Q <sub>gd</sub>		-	2.2	-	
Input Capacitance	C <sub>iss</sub>	V <sub>DS</sub> = 30V, V <sub>GS</sub> = 0V, f = 1.0MHz	-	470	-	pF
Reverse Transfer Capacitance	C <sub>rss</sub>		-	32	-	
Output Capacitance	C <sub>oss</sub>		-	70	-	
Turn-On Delay Time	t <sub>d(on)</sub>	V <sub>GS</sub> = 10V, V <sub>DS</sub> = 30V, I <sub>D</sub> = 17A, R <sub>GEN</sub> = 5Ω	-	7.4	-	ns
Turn-On Rise Time	t <sub>r</sub>		-	15.2	-	
Turn-Off Delay Time	t <sub>d(off)</sub>		-	21.2	-	
Turn-Off Fall Time	t <sub>f</sub>		-	7.6	-	
<b>Drain-Source Body Diode Characteristics</b>						
Source-Drain Diode Forward Voltage	V <sub>SD</sub>	I <sub>S</sub> = 5A, V <sub>GS</sub> = 0V	-	0.8	1.2	V
Body Diode Reverse Recovery Time	t <sub>rr</sub>	I <sub>F</sub> = 17A, di/dt = 100A/μs	-	29	-	ns
Body Diode Reverse Recovery Charge	Q <sub>rr</sub>		-	32	-	nC

Note :

- Surface mounted RF4 board with 2oz. Copper.
- P<sub>D</sub> is based on T<sub>J(MAX)</sub>=150°C
  - P<sub>D</sub> (T<sub>C</sub>=25°C) is based on R<sub>θJC</sub>,
  - P<sub>D</sub> (T<sub>A</sub>=25°C) is based on R<sub>θJA</sub>, t<10sec
- Starting T<sub>J</sub>=25°C, L=1mH, I<sub>AS</sub>=10.0A, V<sub>DD</sub>=60V, V<sub>GS</sub>=10V

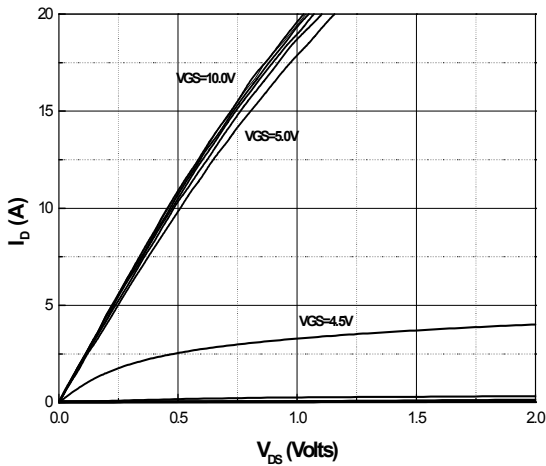

**Fig.1 On-Region Characteristics**

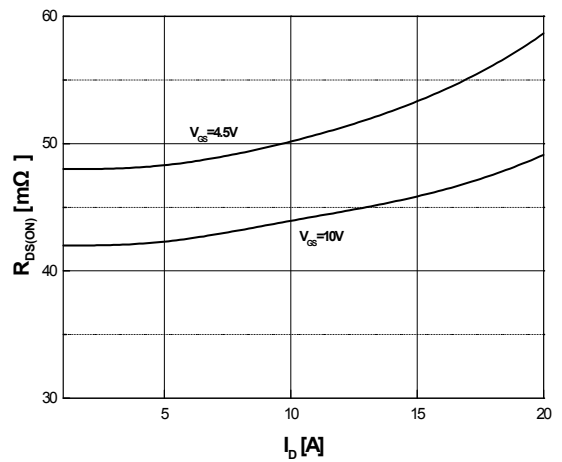

**Fig.2 On-Resistance Variation with Drain Current and Gate Voltage**

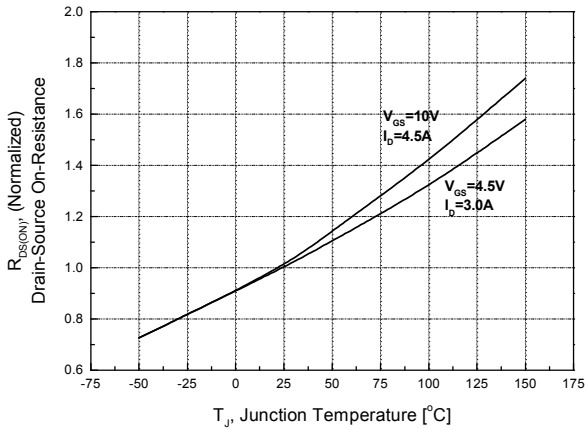

**Fig.3 On-Resistance Variation with Temperature**

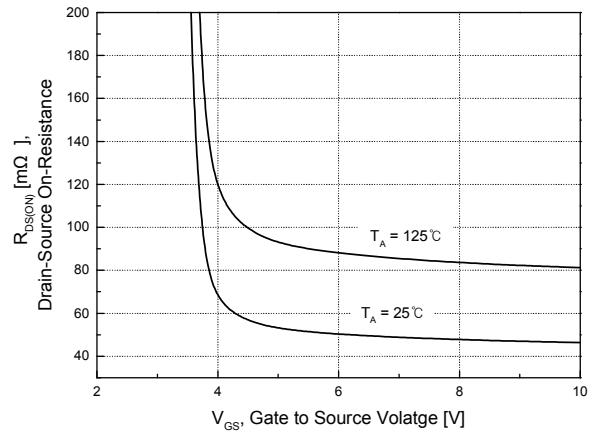

**Fig.4 On-Resistance Variation with Gate to Source Voltage**

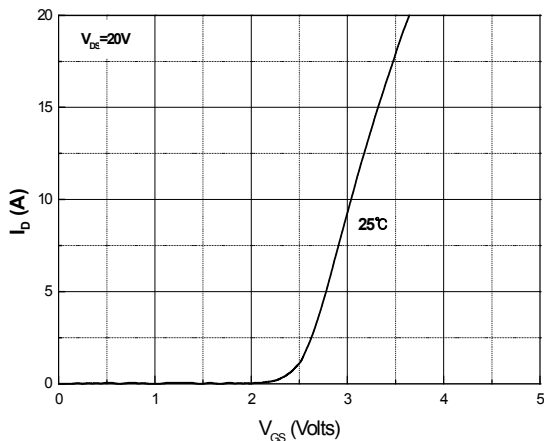

**Fig.5 Transfer Characteristics**

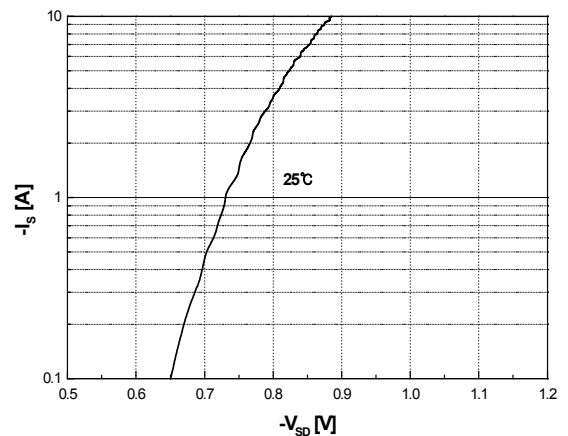

**Fig.6 Body Diode Forward Voltage Variation with Source Current and Temperature**

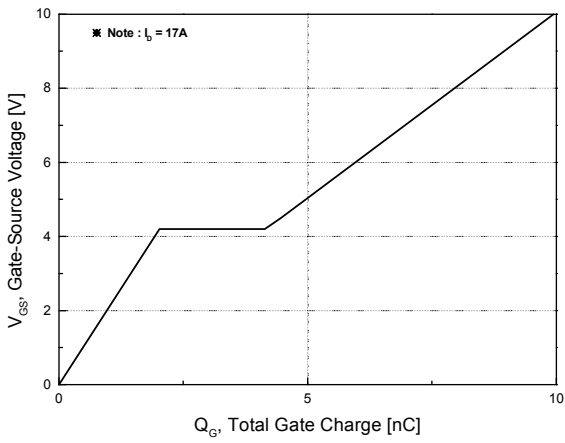

**Fig.7 Gate Charge Characteristics**

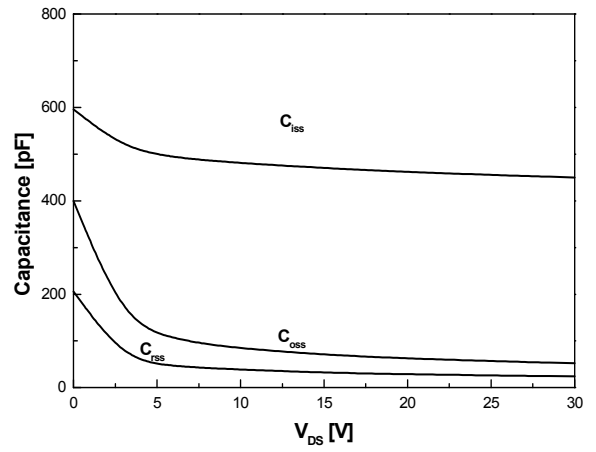

**Fig.8 Capacitance Characteristics**

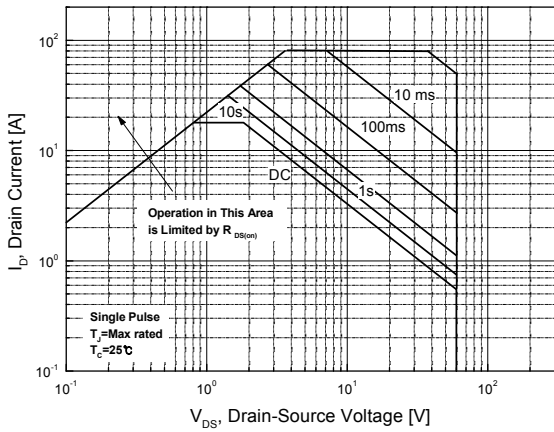

**Fig.9 Maximum Safe Operating Area**

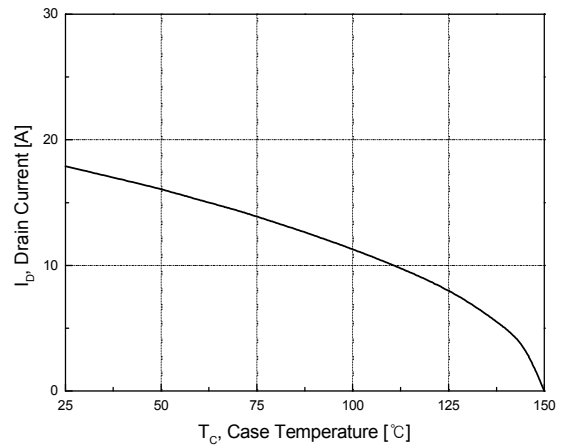

**Fig.10 Maximum Drain Current Vs. Case Temperature**

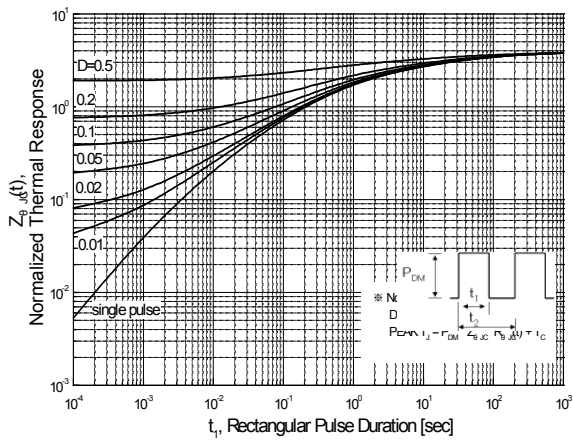
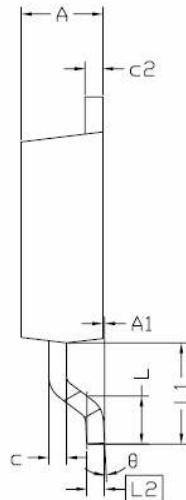
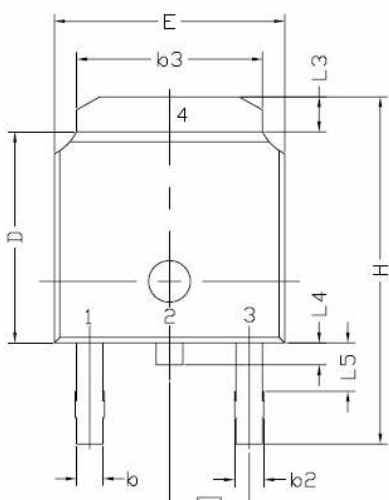

**Fig.11 Transient Thermal Response Curve**

## Physical Dimensions

### 2 Leads, DPAK (TO252)

Dimensions are in millimeters unless otherwise specified



SYMBOL	DIMENSIONAL REQMTS		
	MIN	NOM	MAX
E	6.40	6.60	6.731
L	1.40	1.52	1.77
L1	2.743 REF		
L2	0.508 BSC		
L3	0.89	--	1.27
L4	0.64	--	1.01
L5	--	--	--
D	6.00	6.10	6.223
H	9.40	10.00	10.40
b	0.64	0.76	0.88
b2	0.77	0.84	1.14
b3	5.21	5.34	5.46
e	2.286 BSC		
A	2.20	2.30	2.38
A1	0	--	0.127
c	0.45	0.50	0.60
c2	0.45	0.50	0.58
D1	5.30	--	--
E1	4.40	--	--
theta	0°	--	10°

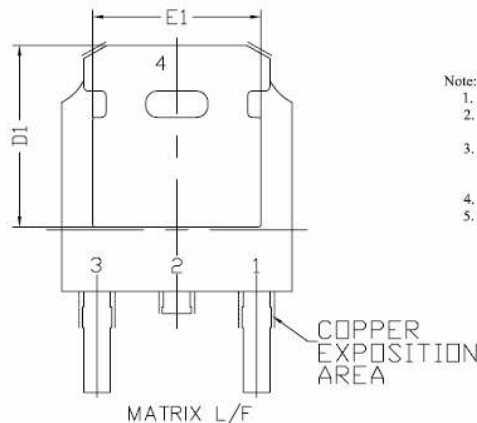
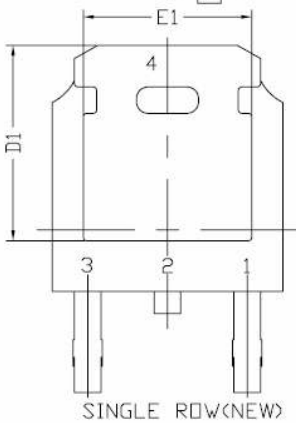

**Note:**

1. All Dimension Are In mm.
2. Package Body Sizes Exclude Mold Flash, Protrusion Or Gate Burrs. Mold Flash, Protrusion Or Gate Burrs Shall Not Exceed 0.10 mm Per Side.
3. Package Body Sizes Determined At The Outermost Extremes Of The Plastic Body Exclusive Of Mold Flash, Gate Burrs And Interlead Flash, But Including Any Mismatch Between The Top And Bottom Of The Plastic Body.
4. The Package Top May Be Smaller Than The Package Bottom.
5. Dimension "b" Does Not Include Dambar Protrusion. Allowable Dambar Protrusion Shall Be 0.10 mm Total In Excess Of "b" Dimension At Maximum Material Condition. The Dambar Cannot Be Located On The Lower Radius Of The Foot.

## Worldwide Sales Support Locations

### U.S.A

#### Sunnyvale Office

787 N. Mary Ave. Sunnyvale  
CA 94085 U.S.A  
Tel : 1-408-636-5200  
Fax : 1-408-213-2450  
E-Mail : americasales@magnachip.com

#### Chicago Office

2300 Barrington Road, Suite 330  
Hoffman Estates, IL 60195 U.S.A  
Tel : 1-847-882-0951  
Fax : 1-847-882-0998

### U.K

Knyvett House The Causeway,  
Staines Middx, TW18 3BA, U.K.  
Tel : +44 (0) 1784-898-8000  
Fax : +44 (0) 1784-895-115  
E-Mail : europesales@magnachip.com

### Japan

#### Tokyo Office

Shinbashi 2-chome MT bldg  
4F 2-5-5 Shinbashi, Minato-ku  
Tokyo, 105-0004 Japan  
Tel : 81-3-3595-0632  
Fax : 81-3-3595-0671  
E-Mail : japansales@magnachip.com

#### Osaka Office

3F, Shin-Osaka MT-2 Bldg  
3-5-36 Miyahara Yodogawa-Ku  
Osaka, 532-0003 Japan  
Tel : 81-6-6394-8224  
Fax : 81-6-6394-8282  
E-Mail : osakasales@magnachip.com

### Taiwan R.O.C

2F, No.61, Chowize Street, Nei Hu  
Taipei, 114 Taiwan R.O.C  
Tel : 886-2-2657-7898  
Fax : 886-2-2657-8751  
E-Mail : taiwansales@magnachip.com

### China

#### Hong Kong Office

Office 03, 42/F, Office Tower Convention Plaza  
1 Harbour Road, Wanchai, Hong Kong  
Tel : 852-2828-9700  
Fax : 852-2802-8183  
E-Mail : chinasales@magnachip.com

#### Shenzhen Office

Room 1803, 18/F  
International Chamber of Commerce Tower  
Fuhua 3Road, Futian District  
ShenZhen, China  
Tel : 86-755-8831-5561  
Fax : 86-755-8831-5565

#### Shanghai Office

Ste 1902, 1 Huaihai Rd. (C) 20021  
Shanghai, China  
Tel : 86-21-6373-5181  
Fax : 86-21-6373-6640

### Korea

891, Daechi-Dong, Kangnam-Gu  
Seoul, 135-738 Korea  
Tel : 82-2-6903-3451  
Fax : 82-2-6903-3668 ~9  
Email : koreasales@magnachip.com

### DISCLAIMER:

The Products are not designed for use in hostile environments, including, without limitation, aircraft, nuclear power generation, medical appliances, and devices or systems in which malfunction of any Product can reasonably be expected to result in a personal injury. Seller's customers using or selling Seller's products for use in such applications do so at their own risk and agree to fully defend and indemnify Seller.

MagnaChip reserves the right to change the specifications and circuitry without notice at any time. MagnaChip does not consider responsibility for use of any circuitry other than circuitry entirely included in a MagnaChip product. **MagnaChip** is a registered trademark of MagnaChip Semiconductor Ltd.