

FEATURES

- BROAD BAND INTERNALLY MATCHED FET
- HIGH POWER
P1dB= 36.5dBm at 11.7GHz to 12.7GHz
- HIGH GAIN
G1dB= 9.5dB at 11.7GHz to 12.7GHz
- LOW INTERMODULATION DISTORTION
IM3=-45dBc at Pout= 24.0dBm
Single Carrier Level
- HERMETICALLY SEALED PACKAGE

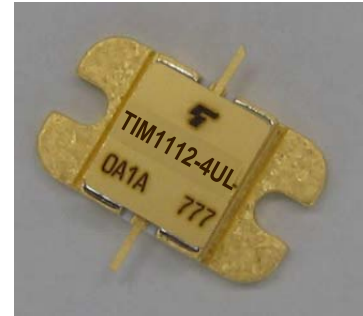

RF PERFORMANCE SPECIFICATIONS (Ta= 25°C)

CHARACTERISTICS	SYMBOL	CONDITIONS	UNIT	MIN.	TYP.	MAX.
Output Power at 1dB Gain Compression Point	P1dB	VDS= 10V DSset= 1.0A f=11.7 to 12.7 GHz	dBm	35.5	36.5	—
Power Gain at 1dB Gain Compression Point	G1dB		dB	8.5	9.5	—
Drain Current	IDS1		A	—	1.1	1.6
Gain Flatness	ΔG		dB	—	—	±0.8
Power Added Efficiency	ηadd		%	—	36	—
3rd Order Intermodulation Distortion	IM3	Two Tone Test Po= 24.0dBm, Δf= 5MHz (Single Carrier Level)	dBc	-42	-45	—
Drain Current	IDS2		A	—	1.1	1.6
Channel Temperature Rise	ΔTch	(VDS X IDS + Pin - P1dB) X Rth(c-c)	°C	—	—	60

Recommended Gate Resistance(Rg): 150 Ω

ELECTRICAL CHARACTERISTICS (Ta= 25°C)

CHARACTERISTICS	SYMBOL	CONDITIONS	UNIT	MIN.	TYP.	MAX.
Transconductance	gm	VDS= 3V IDS= 1.2A	S	—	1.2	—
Pinch-off Voltage	VGSoff	VDS= 3V IDS= 40mA	V	-0.5	-2.0	-4.5
Saturated Drain Current	IDSS	VDS= 3V VGS= 0V	A	—	2.2	—
Gate-Source Breakdown Voltage	VGSO	IGS= -40μA	V	-5	—	—
Thermal Resistance	Rth(c-c)	Channel to Case	°C/W	—	3.8	4.4

- ◆ The information contained herein is presented as guidance for product use. No responsibility is assumed by TOSHIBA for any infringement of patents or any other intellectual property rights of third parties that may result from the use of product. No license to any intellectual property right is granted by this document. The information contained herein is subject to change without prior notice. It is advisable to contact TOSHIBA before proceeding with design of equipment incorporating this product.

ABSOLUTE MAXIMUM RATINGS (Ta= 25°C)

CHARACTERISTICS	SYMBOL	UNIT	RATING
Drain-Source Voltage	VDS	V	15
Gate-Source Voltage	VGS	V	-5
Drain Current	IDS	A	3.3
Total Power Dissipation (Tc= 25°C)	PT	W	34.1
Channel Temperature	Tch	°C	175
Storage Temperature	Tstg	°C	-65 to +175

PACKAGE OUTLINE (2-9D1B)

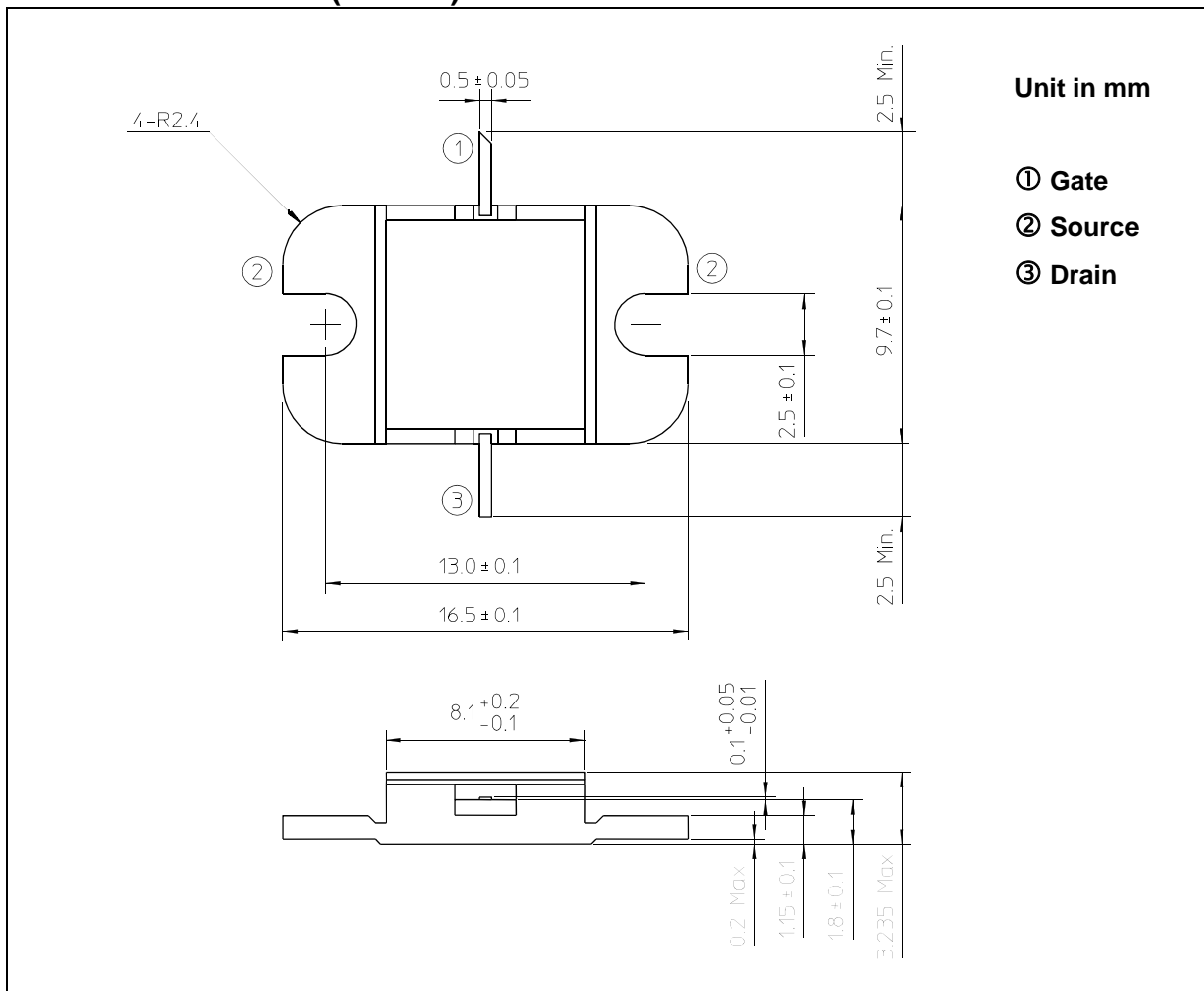

HANDLING PRECAUTIONS FOR PACKAGE MODEL

Soldering iron should be grounded and the operating time should not exceed 10 seconds at 260°C or 3 seconds at 350°C.