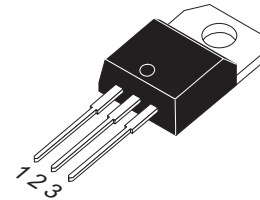
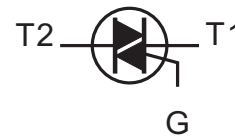

Simplified outline
TO-220AB

Description

Glass passivated triacs in a plastic envelope, intended for use in applications requiring high bidirectional transient and blocking voltage capability and high thermal cycling performance. Typical applications include motor control, industrial and domestic lighting, heating and static switching.

Features

- Blocking voltage to 600 V
- On-state RMS current to 8 A

Symbol

Applications

- Motor control
- Industrial and domestic lighting
- Heating
- Static switching

Pin	Description
1	Main terminal 1 (T1)
2	Main terminal 2 (T2)
3	gate (G)
TAB	Main terminal

SYMBOL	PARAMETER	Value	Unit
V_{DRM}	Repetitive peak off-state voltages	600	V
$I_T (RMS)$	RMS on-state current (full sine wave)	8	A
I_{TSM}	Non-repetitive peak on-state current (full cycle, T_j initial=25°C)	84	A

SYMBOL	PARAMETER	CONDITIONS	MIN	TYP	MAX	UNIT
$R_{th(j-c)}$	Junction to case(AC)		-	2.5	-	°C/W
$R_{th(j-a)}$	Junction to ambient		-	60	-	°C/W

Limiting values in accordance with the Maximum system(IEC 134)

SYMBOL	PARAMETER	CONDITIONS			MIN	Value	UNIT
V_{DRM}	Repetitive peak off-state Voltages				-	600	V
$I_{T(RMS)}$	RMS on-state current	$T_c=100^{\circ}C$			-	8	A
I_{TSM}	Non repetitive surge peak on-state current	Full cycle T_j initial =25 $^{\circ}C$	F=50Hz	t=20ms	-	80	A
			F=60Hz	t=16.7ms	-	84	A
I^2t	I^2t value for fusing	$T_p=10ms$			-	36	A ² S
dI/dt	Critical rate of rise of on-state current	$I_G=2 \times I_{GT}$, $tr \leq 100ns$	F=120Hz	$T_j=125^{\circ}C$	-	50	A/ μ s
I_{GM}	Peak gate current	$tp=20\mu s$		$T_j=125^{\circ}C$	-	4	A
I_{DRM}	$V_{DRM}=V_{RRM}$				-	5	μ A
I_{RRM}	$V_{DRM}=V_{RRM}$				-	1	mA
$P_{G(AV)}$	Average gate power				-	1	W
T_{stg}	Storage temperature range				-40	150	$^{\circ}C$
T_j	Operating junction Temperature range				-40	125	$^{\circ}C$

 $T_j = 25^{\circ}C$ unless otherwise stated

SYMBOL	PARAMETER	CONDITIONS			MIN	TYP	MAX	UNIT
Static characteristics								
I_{GT}		$V_D=12V$; $R_L=30\Omega$	I-II-III	-	-	25	mA	
			IV	-	-	50	mA	
I_L		$I_G=1.2 I_{GT}$	I-III-IV	-	-	40	mA	
			II	-	-	80	mA	
I_H		$I_T=500mA$		-	-	25	mA	
V_{GT}		$V_D=12V$; $R_L=30\Omega$	ALL	-	-	1.3	V	
V_{GD}		$V_D=V_{DRM}$ $R_L=3.3K\Omega$ $T_j=125^{\circ}C$	ALL	0.2	-	-	V	
dV/dt		$V_D=67\%V_{DRM}$ gate open; $T_j=125^{\circ}C$			200	-	-	V/ μ s
(dV/dt)c	(dI/dt)c=3.5A/ms	$T_j=125^{\circ}C$			5	-	-	V/ μ s

Dynamic Characteristics

V_{TM}	$I_{TM}=11A$ $tp=380\mu s$	$T_j=25^{\circ}C$	-	-	1.55	V
V_{TO}	Threshold voltage	$T_j=125^{\circ}C$	-	-	0.85	V
R_d	Dynamic resistance	$T_j=125^{\circ}C$	-	-	50	m Ω

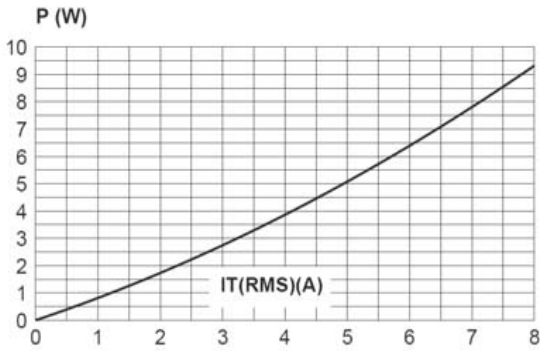
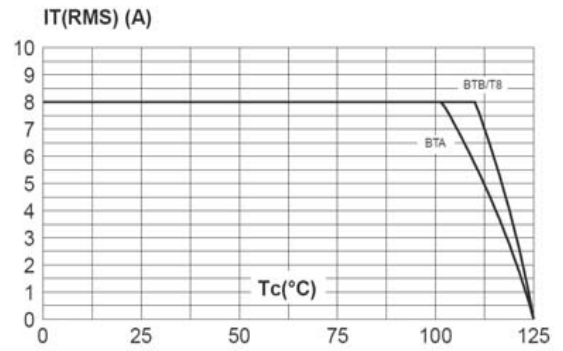
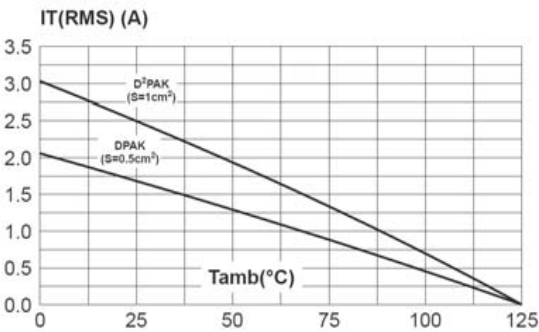
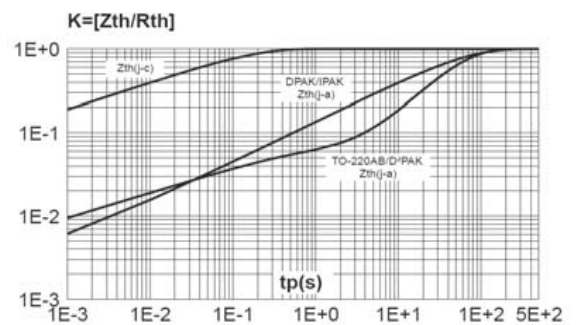
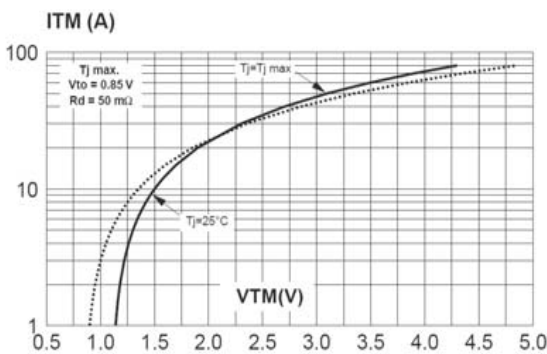
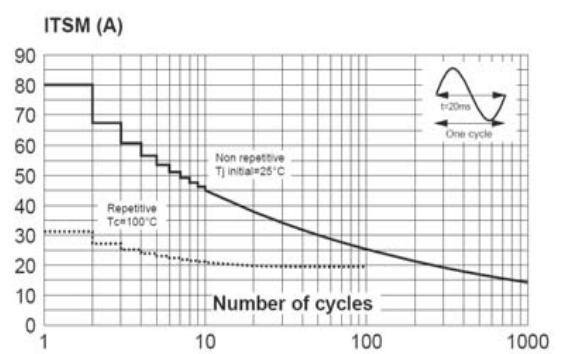
Description
Fig. 1: Maximum power dissipation versus RMS on-state current (full cycle).

Fig. 2-1: RMS on-state current versus case temperature (full cycle).

Fig. 2-2: RMS on-state current versus ambient temperature (printed circuit board FR4, copper thickness: 35µm), full cycle.

Fig. 3: Relative variation of thermal impedance versus pulse duration.

Fig. 4: On-state characteristics (maximum values).

Fig. 5: Surge peak on-state current versus number of cycles.

Description

Fig. 6: Non-repetitive surge peak on-state current for a sinusoidal pulse with width $t_p < 10\text{ms}$, and corresponding value of I^2t .

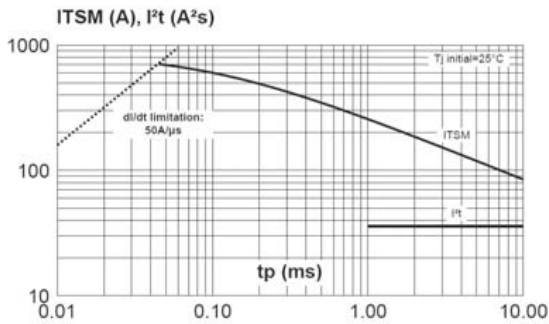

Fig. 7: Relative variation of gate trigger current, holding current and latching current versus junction temperature (typical values).

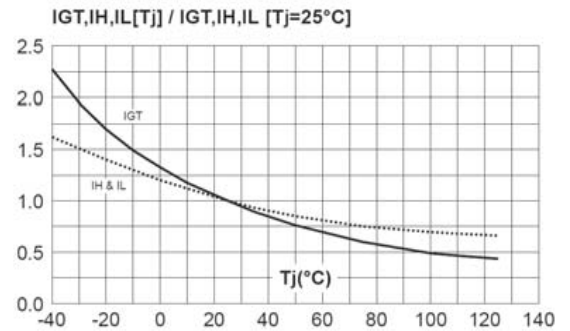

Fig. 8-1: Relative variation of critical rate of decrease of main current versus $(dV/dt)_c$ (typical values). Snubberless & Logic Level Types

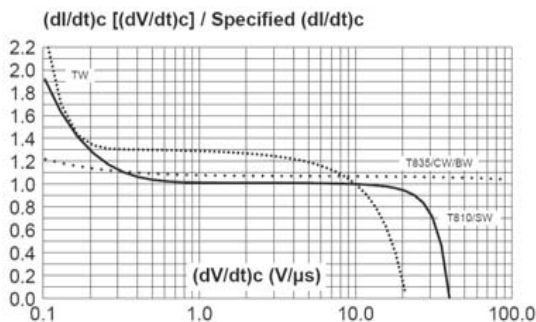

Fig. 8-2: Relative variation of critical rate of decrease of main current versus $(dV/dt)_c$ (typical values). Standard Types

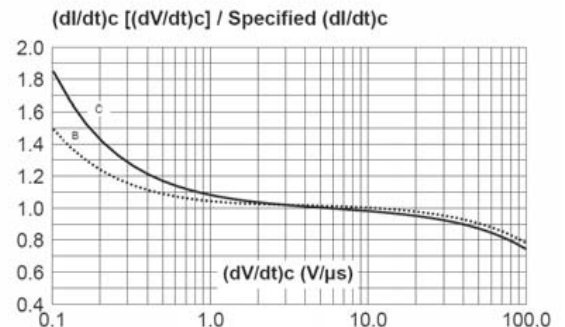

Fig. 9: Relative variation of critical rate of decrease of main current versus junction temperature.

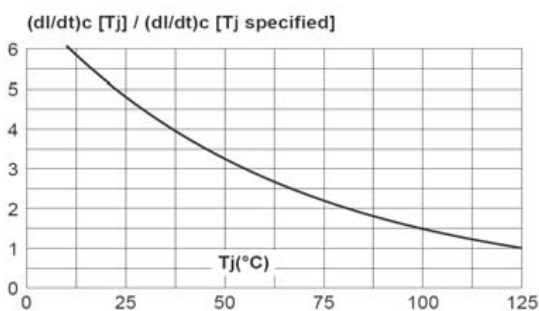
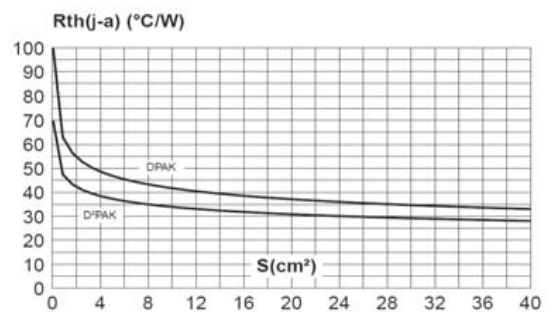
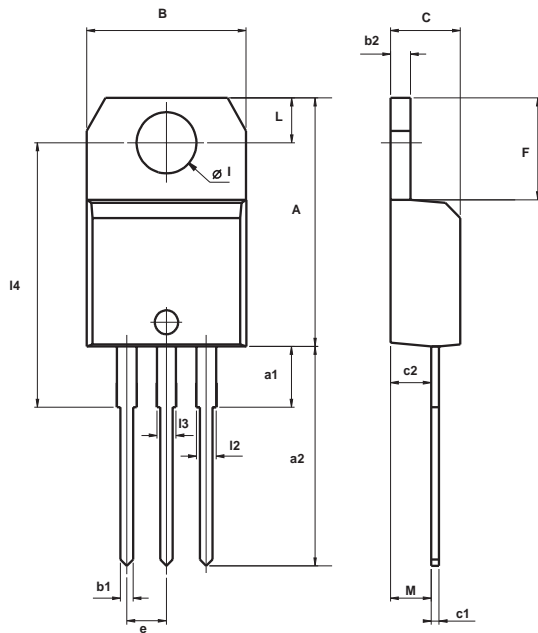

Fig. 10: DPAK and D²PAK Thermal resistance junction to ambient versus copper surface under tab (printed circuit board FR4, copper thickness: 35 µm).



Package Mechanical Data
TO-220AB (Plastic)

REF.	DIMENSIONS					
	Millimeters			Inches		
	Min.	Typ.	Max.	Min.	Typ.	Max.
A	15.20		15.90	0.598		0.625
a1		3.75			0.147	
a2	13.00		14.00	0.511		0.551
B	10.00		10.40	0.393		0.409
b1	0.61		0.88	0.024		0.034
b2	1.23		1.32	0.048		0.051
C	4.40		4.60	0.173		0.181
c1	0.49		0.70	0.019		0.027
c2	2.40		2.72	0.094		0.107
e	2.40		2.70	0.094		0.106
F	6.20		6.60	0.244		0.259
I	3.75		3.85	0.147		0.151
I4	15.80	16.40	16.80	0.622	0.646	0.661
L	2.65		2.95	0.104		0.116
I2	1.14		1.70	0.044		0.066
I3	1.14		1.70	0.044		0.066
M		2.60			0.102	