

Simplified outline TO-220AB

Description

high bidirectional blocking voltage capability and also suitable for over voltage protection ,motor high bidirectional blocking voltage capability and also suitable for over voltage protection motor control circuit in power tool, inrush current limit circuit and heating control system.

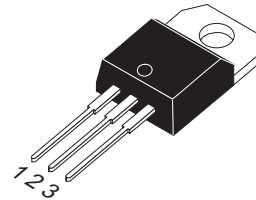

Symbol

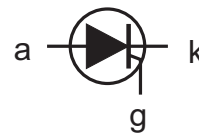

Features

- Blocking voltage to 800 V
- On-state RMS current to 25 A

Applications

- Motor control
- Industrial and domestic lighting
- Heating
- Static switching

Pin	Description
1	cathode
2	anode
3	gate
TAB	anode

SYMBOL	PARAMETER	Value	Unit
V_{DRM}	Repetitive peak off-state voltages MCR25DG MCR25MG MCR25NG	400 600 800	V
$I_{T(RMS)}$	RMS on-state current (full sine wave)	25	A
I_{TSM}	Non-repetitive peak on-state current (full cycle, T_j initial=25°C)	300	A

SYMBOL	PARAMETER	CONDITIONS	MIN	TYP	MAX	UNIT
$R_{\theta jc}$	Thermal resistance Junction to Case		-	-	1.5	°C/W
$R_{\theta jA}$	Thermal resistance Junction to ambient		-	-	62.5	°C/W



MCR25DG, MCR25MG, MCR25NG

Limiting values in accordance with the Maximum system(IEC 134)

SYMBOL	PARAMETER	CONDITIONS	MIN	Value	UNIT
V_{DRM}	Repetitive peak off-state Voltages	$T_J = -40$ to 125°C , sine wave, 50 to 60Hz, Gate Open MCR25DG MCR25MG MCR25NG	-	400 600 800	V
$I_{T(RMS)}$	RMS on-state current	180°C conduction angles; $T_C = 80^\circ\text{C}$	-	25	A
I_{TSM}	Non-repetitive peak On-state current	1/2 Cycle, sine wave 60 Hz, $T_J = 125^\circ\text{C}$	-	300	A
I^2t	I^2t for fusing	$T = 8.3\text{ms}$	-	373	A^2S
di/dt	Critical rate of rise of on-state current	$I_{pk} = 50\text{A}$, $p_w = 30\mu\text{sec}$, $dI_G/dt = 1\text{A}/\mu\text{sec}$, $I_{gt} = 50\text{mA}$	-	50	$\text{A}/\mu\text{s}$
I_{GM}	Forward peak gate current	pulse wdt $t_j \leq 1.0\mu\text{s}$, $T_C = 80^\circ\text{C}$	-	2.0	A
T_L	Maximum lead temperature for soldering purposes 1/8" from case for 10 seconds		-	260	$^\circ\text{C}$
P_{GM}	Peak gate power	pulse wdt $t_j \leq 1.0\mu\text{s}$, $T_C = 80^\circ\text{C}$	-	20	W
$P_{G(AV)}$	Average gate power	$T = 8.3\text{ms}$, $T_C = 80^\circ\text{C}$	-	0.5	W
T_{stg}	Storage temperature		-40	+150	$^\circ\text{C}$
T_j	Operating junction Temperature Range		-40	+125	$^\circ\text{C}$

$T_J = 25^\circ\text{C}$ unless otherwise stated

SYMBOL	PARAMETER	CONDITIONS	MIN	TYP	MAX	UNIT
Static characteristics						
I_{GT}	Gate trigger current	$V_D = 12\text{V}$; $R_L = 100\Omega$	4.0	12	30	mA
I_{DRM} I_{RRM}	Peak Reverse/forward current (at $V_{AK} = \text{Rated } V_{DRM}$ or V_{RRM} , Gate Open)	$T_J = 25^\circ\text{C}$ $T_J = 125^\circ\text{C}$	-	-	0.01 2.0	mA
I_H	Holding current	$V_D = 12\text{Vdc}$; Initiating Current = 200mA, gate open	5.0	13	40	mA
V_{TM}	Peak forward on-state voltage	$I_{TM} = 50\text{A}$	-	-	1.8	V
V_{GT}	Gate trigger voltage	$V_D = 12\text{V}$; $R_L = 100\Omega$	0.5	0.67	1.0	V
I_L	Latching current	$V_D = 12\text{V}$; $I_G = 30\text{mA}$	-	35	80	mA

Dynamic Characteristics

D_v/dt	Critical rate of rise of Off-state voltage	$V_D = 67\%$ of Rated V_{DRM} , $T_J = 125^\circ\text{C}$ Exponential waveform;	100	250	-	$\text{V}/\mu\text{s}$
t_{gt}	Gate controlled turn-on time	$I_{TM} = 16\text{A}$; $V_D = \text{Rated } V_{DRM}$, $I_G = 2\text{mA}$	-	-	-	μs
t_g	Circuit commutated turn-off time		-	-	-	μs

Description

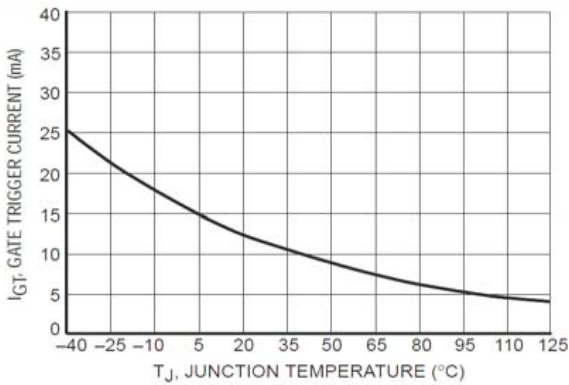

Figure 1. Typical Gate Trigger Current versus Junction Temperature

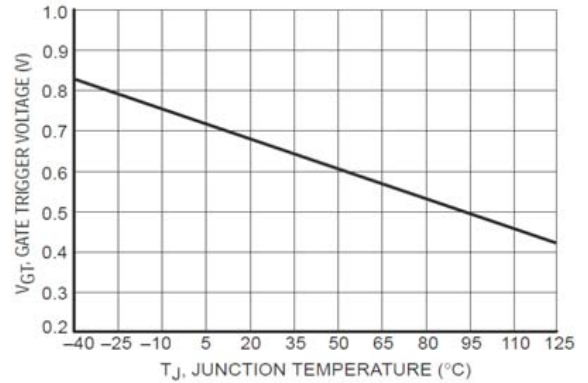

Figure 2. Typical Gate Trigger Voltage versus Junction Temperature

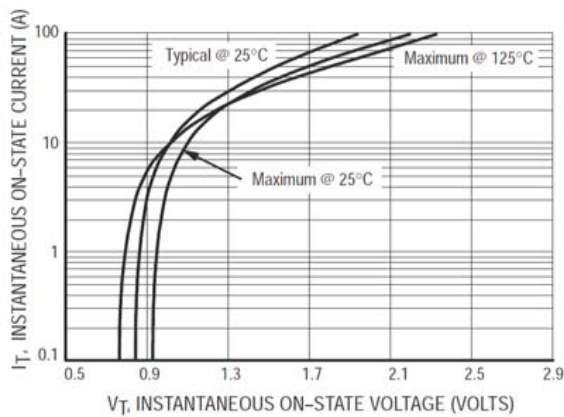

Figure 3. Typical On-State Characteristics

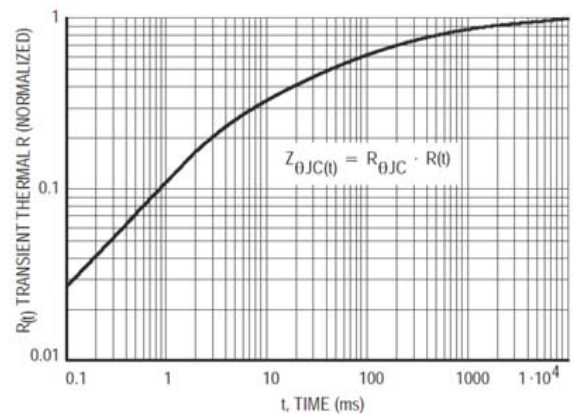

Figure 4. Transient Thermal Response

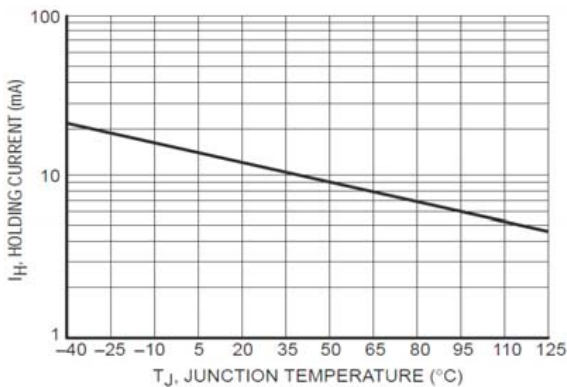

Figure 5. Typical Holding Current versus Junction Temperature

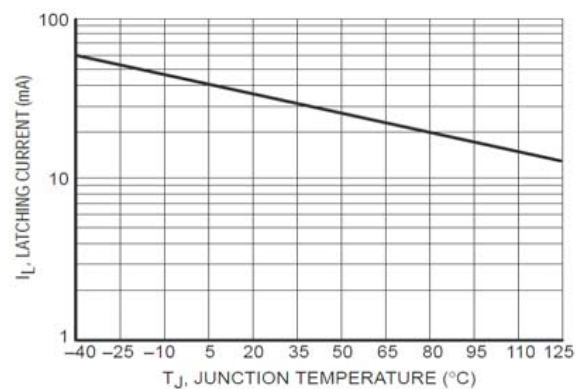

Figure 6. Typical Latching Current versus Junction Temperature

Description

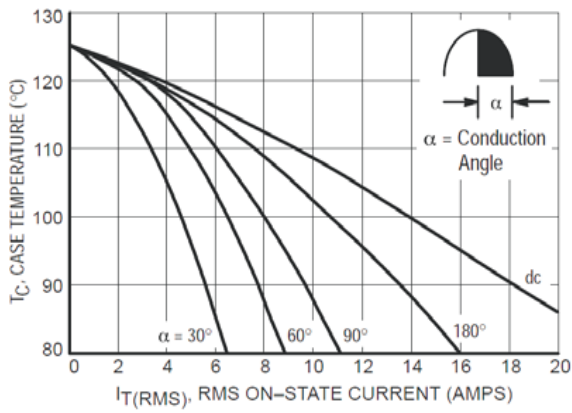

Figure 7. Typical RMS Current Derating

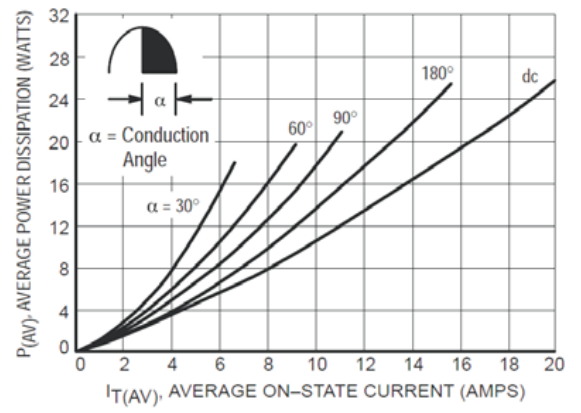

Figure 8. On State Power Dissipation

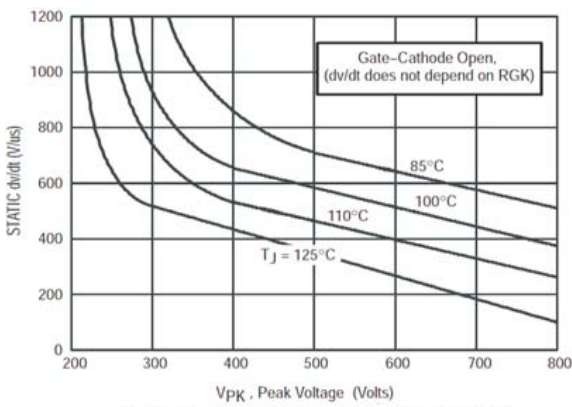

Figure 9. Typical Exponential Static dv/dt Versus Peak Voltage.

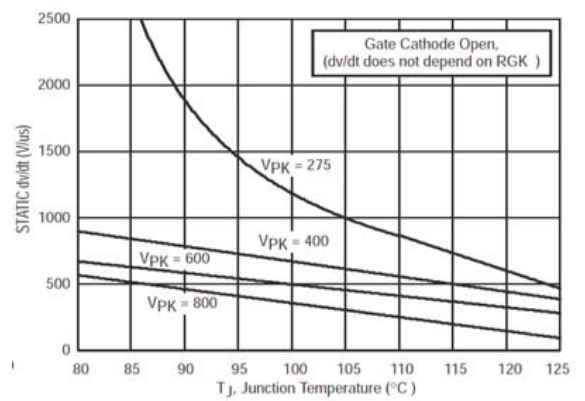

Figure 10. Typical Exponential Static dv/dt Versus Junction Temperature.

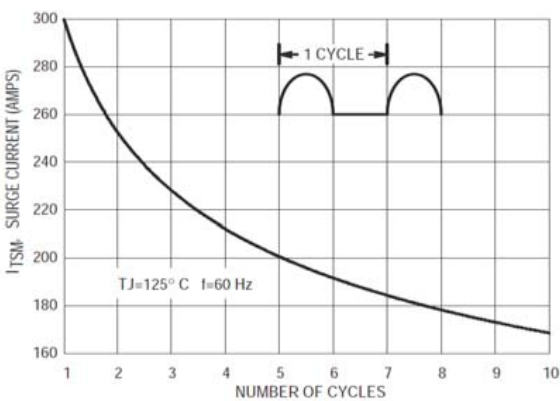
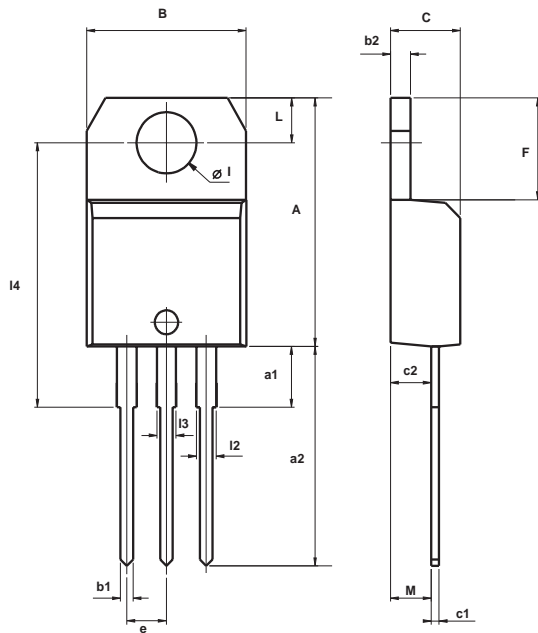

Figure 11. Maximum Non-Repertive Surge Current

Package Mechanical Data

TO-220AB (Plastic)



REF.	DIMENSIONS					
	Millimeters			Inches		
	Min.	Typ.	Max.	Min.	Typ.	Max.
A	15.20		15.90	0.598		0.625
a1		3.75			0.147	
a2	13.00		14.00	0.511		0.551
B	10.00		10.40	0.393		0.409
b1	0.61		0.88	0.024		0.034
b2	1.23		1.32	0.048		0.051
C	4.40		4.60	0.173		0.181
c1	0.49		0.70	0.019		0.027
c2	2.40		2.72	0.094		0.107
e	2.40		2.70	0.094		0.106
F	6.20		6.60	0.244		0.259
I	3.75		3.85	0.147		0.151
I4	15.80	16.40	16.80	0.622	0.646	0.661
L	2.65		2.95	0.104		0.116
I2	1.14		1.70	0.044		0.066
I3	1.14		1.70	0.044		0.066
M		2.60			0.102	