

BYV27-600

**SINTERED GLASS JUNCTION
ULTRAFAST AVALANCHE RECTIFIER**
VOLTAGE: 600V CURRENT: 1.6A



FEATURE

Glass passivated
High maximum operating temperature
Low leakage current
Excellent stability
Guaranteed avalanche energy absorption capability

MECHANICAL DATA

Case: SOD-57 sintered glass case
Terminal: Plated axial leads solderable per MIL-STD 202E, method 208C
Polarity: color band denotes cathode end
Mounting position: any

SOD-57

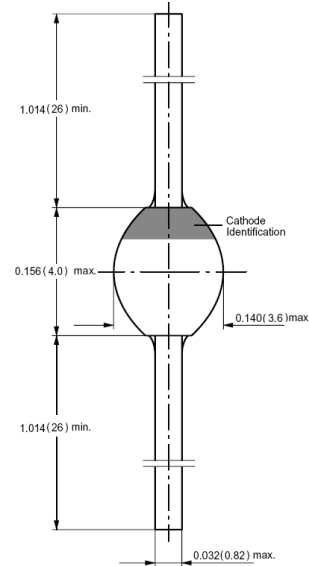

Dimensions in inches and (millimeters)

MAXIMUM RATINGS AND ELECTRICAL CHARACTERISTICS

(single-phase, half-wave, 60HZ, resistive or inductive load rating at 25°C, unless otherwise stated)

	SYMBOL	BYV27-600	units
Maximum Recurrent Peak Reverse Voltage	V_{RRM}	600	V
Maximum RMS Voltage	V_{RMS}	420	V
Maximum DC blocking Voltage	V_{DC}	600	V
Reverse avalanche breakdown voltage at $I_R = 0.1 \text{ mA}$	$V_{(BR)R}$	675min	V
Maximum Average Forward Rectified Current 3/8" lead length at $T_{tp} = 85^\circ\text{C}$	I_{FAV}	1.6	A
Non-repetitive Peak Forward Current at $t=10\text{ms}$ half sine wave	I_{FSM}	40	A
Maximum Forward Voltage at Forward Current 2.0A	V_F	1.25	V
Non-repetitive peak reverse avalanche energy (Note 1)	E_{RSM}	20	mJ
Maximum DC Reverse Current $T_a = 25^\circ\text{C}$ at rated DC blocking voltage $T_a = 165^\circ\text{C}$	I_R	5.0 150.0	μA
Maximum Reverse Recovery Time (Note 2)	T_{rr}	50	nS
Diode Capacitance (Note 3)	C_d	65	pF
Typical Thermal Resistance (Note 4)	$R_{th(ja)}$	100	K/W
Storage and Operating Junction Temperature	T_{stg}, T_j	-65 to +175	$^\circ\text{C}$

Note:

1. $R=400\text{mA}$; $T_j=T_{jmax}$ prior to surge; inductive load switched off
2. Reverse Recovery Condition $I_f = 0.5\text{A}$, $I_r = 1.0\text{A}$, $I_{rr} = 0.25\text{A}$
3. Measured at 1.0 MHz and applied reverse voltage of 0Vdc
4. Device mounted on an epoxy-glass printed-circuit board, 1.5mm thick; thickness of Cu-layer $\geq 40 \mu\text{m}$

RATINGS AND CHARACTERISTIC CURVES BYV27-600

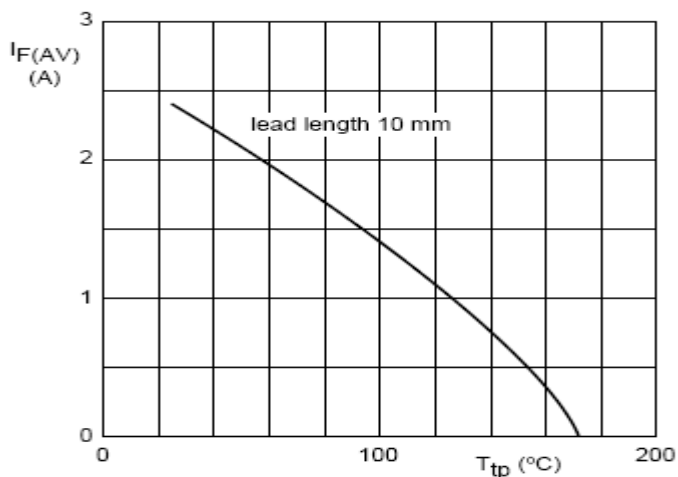

Fig.1 Maximum permissible average forward current as a function of tie-point temperature (including losses due to reverse leakage).

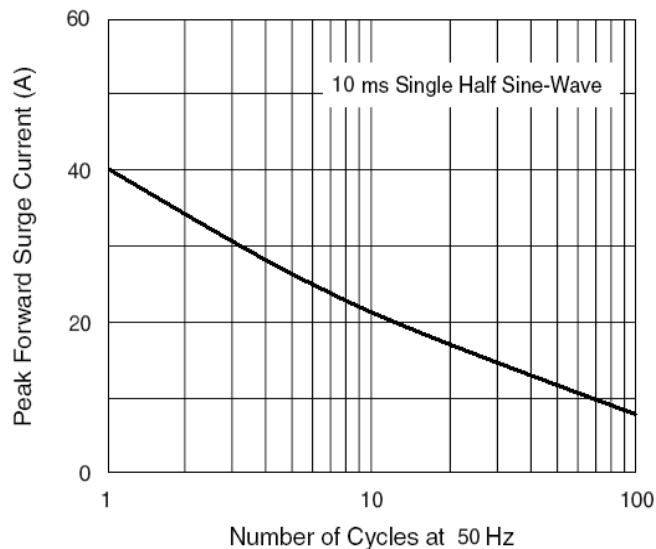

Fig.2 Maximum non-repetitive peak forward surge current

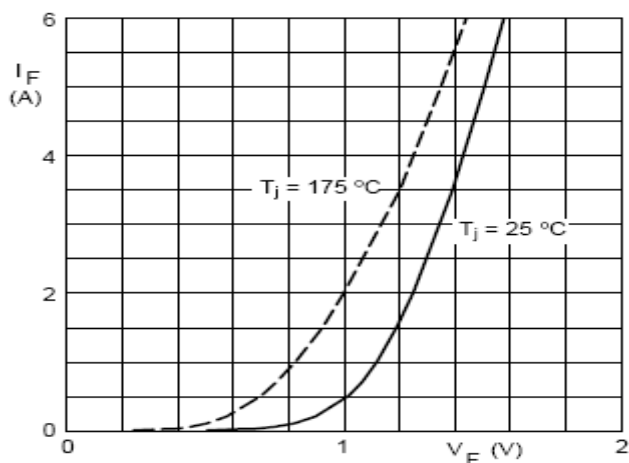

Fig.3 Forward current as a function of forward voltage; maximum values.

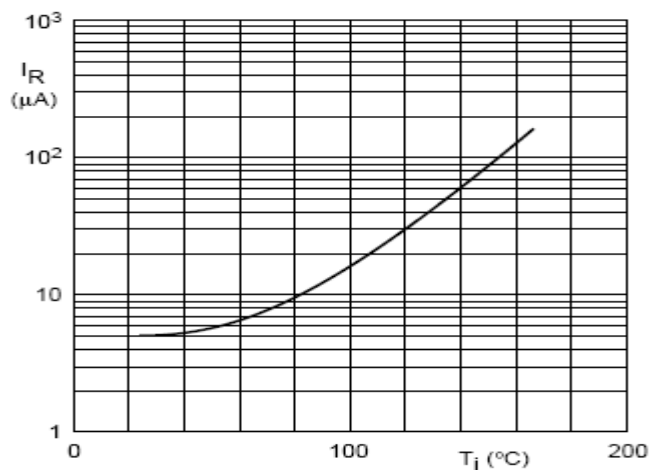

Fig.4 Reverse current as a function of junction temperature; maximum values.

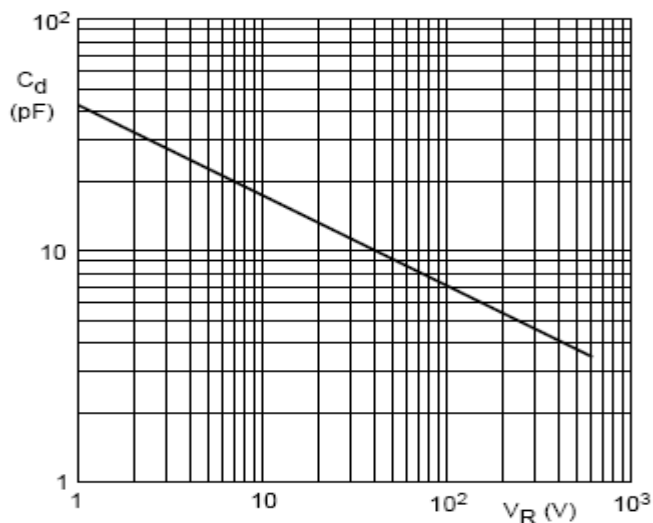

Fig.5 Diode capacitance as a function of reverse voltage; typical values.

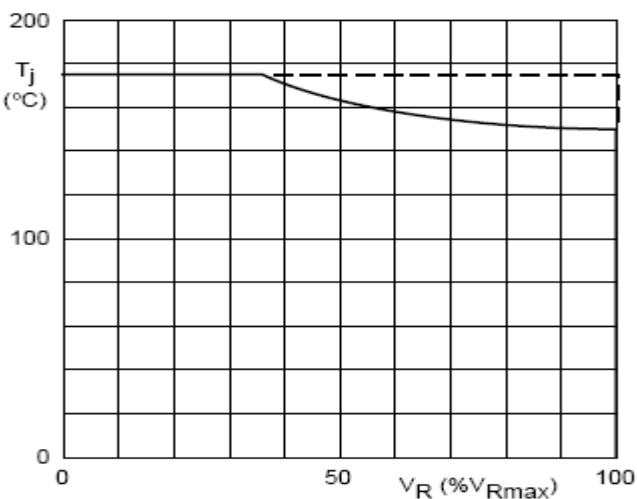

Fig.6 Maximum permissible junction temperature as a function of maximum reverse voltage percentage.