

■ Features

- Dual rectifier construction, positive centetap, offer 8.0A half wave and 16.0A full wave rectification.
- Low power loss, high efficiency.
- High surge current capability.
- Super fast recovery time for switching mode application.
- Low power loss.
- Glass passivated chip junctions.
- Suffix "G" indicates Halogen-free part, ex. ET16005CTG.
- Lead-free parts meet environmental standards of MIL-STD-19500 /228

■ Mechanical data

- Epoxy : UL94-V0 rated flame retardant.
- Case : JEDEC TO-220AB molded plastic body over passivated chip.
- Lead : Axial leads, solderable per MIL-STD-202, Method 208 guranteed.
- Polarity: Color band denotes cathode end.
- Mounting Position : Any.
- Weight : Approximated 2.25 gram.

■ Maximum ratings and electrical characteristics

Rating at 25°C ambient temperature unless otherwise specified. Single phase, half wave, 60Hz, resistive or inductive load. For capacitive load, derate current by 20%.

■ Outline

TO-220AB

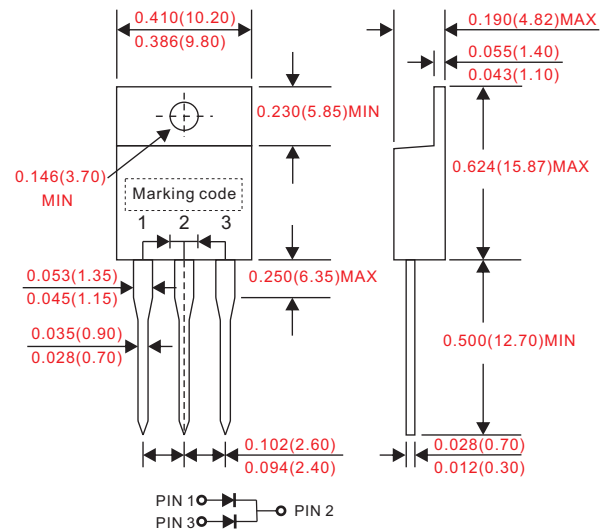

Parameter	Conditions	Symbol	MIN.	TYP.	MAX.	UNIT
Forward rectified current		I_o			16	A
Forward surge current	8.3ms single half sine-wave superimposed on rate load (JEDEC method)	I_{FSM}			125	A
Reverse current	$V_R = V_{RRM}$ $T_A = 25^\circ\text{C}$	I_R			1.0	uA
	$V_R = V_{RRM}$ $T_A = 125^\circ\text{C}$				300	
Diode junction capacitance	f=1MHz and applied 4V DC reverse voltage	C_j		62		pF
Storage temperature		T_{STG}	-50		+150	°C

Symbol	Marking code	Max. repetitive peak reverse voltage V_{RRM} (V)	Max. RMS voltage V_{RMS} (V)	Max. DC blocking voltage V_R (V)	Max. forward voltage @8A, $T_A = 25^\circ\text{C}$ V_F (V)	Max. reverse recovery time(1) T_{rr} (ns)	Operating temperature T_J (°C)
ET16005CT	ET16005CT	50	35	50	0.95	35	-50 ~ +150
ET1601CT	ET1601CT	100	70	100			
ET1602CT	ET1602CT	200	140	200			
ET1604CT	ET1604CT	400	280	400	1.30	75	
ET1606CT	ET1606CT	600	420	600			
ET1608CT	ET1608CT	800	560	800	1.70		
ET1610CT	ET1610CT	1000	700	1000			

Note : 1. $I_F = 0.5A$, $I_R = 1.0A$, $I_{RR} = 0.25A$

Rating and characteristic curves

FIG.1- TEST CIRCUIT DIAGRAM AND REVERSE RECOVERY TIME CHARACTERISTIC

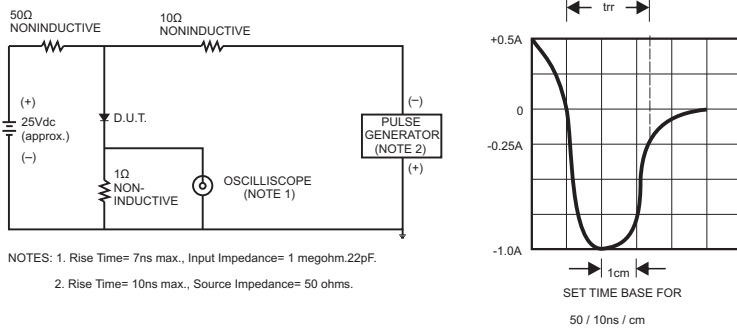

FIG.2-TYPICAL FORWARD CURRENT DERATING CURVE

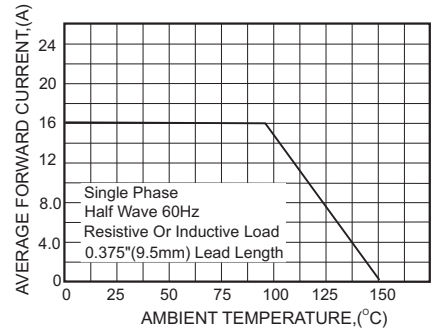

FIG. 3 - TYPICAL INSTANTANEOUS FORWARD CHARACTERISTICS

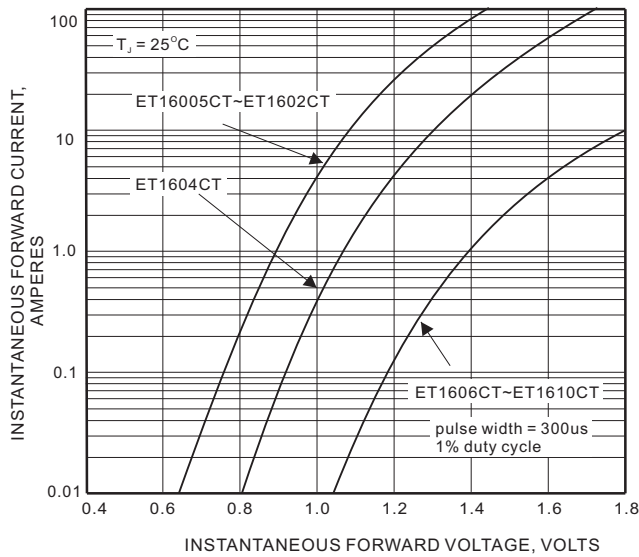

FIG.4-TYPICAL REVERSE CHARACTERISTICS

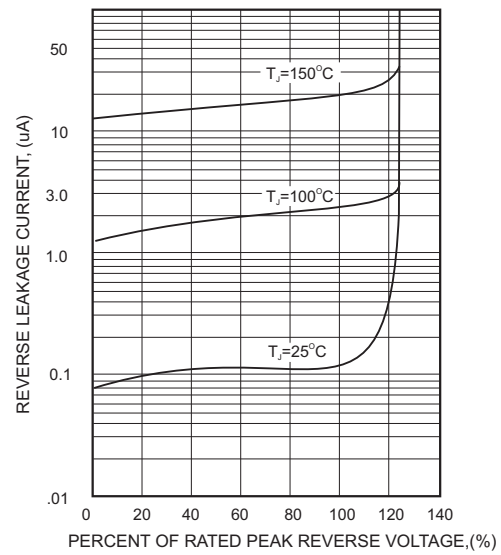

FIG.5-MAXIMUM NON-REPETITIVE

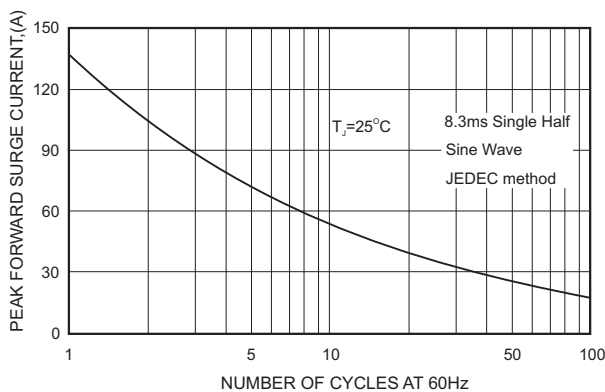
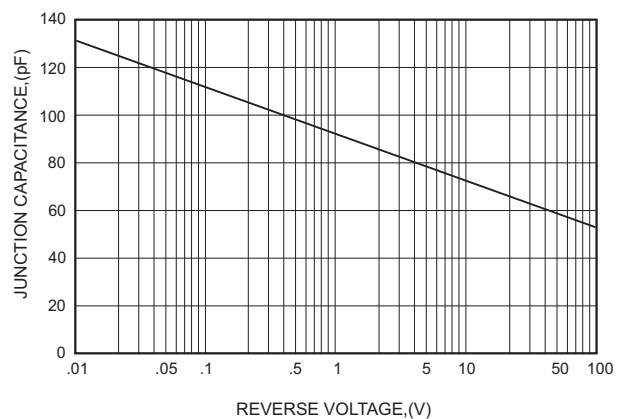

FIG.6-TYPICAL JUNCTION CAPACITANCE



- CITC reserves the right to make changes to this document and its products and specifications at any time without notice.
- Customers should obtain and confirm the latest product information and specifications before final design, purchase or use.
- CITC makes no warranty, representation or guarantee regarding the suitability of its products for any particular purpose, nor does CITC assume any liability for application assistance or customer product design.
- CITC does not warrant or accept any liability with products which are purchased or used for any unintended or unauthorized application.
- No license is granted by implication or otherwise under any intellectual property rights of CITC.
- CITC products are not authorized for use as critical components in life support devices or systems without express written approval of CITC.