

■ Features

- Low power loss, high efficiency.
- High current capability, low forward voltage drop.
- High surge capability.
- Guardring for overvoltage protection.
- Ultra high-speed switching.
- Silicon epitaxial planar chip, metal silicon junction.
- Suffix "G" indicates Halogen-free part, ex. MBRB3040CTG.
- Lead-free parts meet environmental standards of MIL-STD-19500 /228

■ Mechanical data

- Epoxy : UL94-V0 rated flame retardant.
- Case : Molded plastic, TO-263 / D²PAK
- Terminals : Solder plated, solderable per MIL-STD-750, Method 2026
- Polarity: Indicated by cathode band.
- Mounting Position : Any.
- Weight : Approximated 1.70 gram.

■ Maximum ratings and electrical characteristics

Rating at 25°C ambient temperature unless otherwise specified. Single phase, half wave, 60Hz, resistive or inductive load. For capacitive load, derate current by 20%.

■ Outline

D²PAK(TO-263)

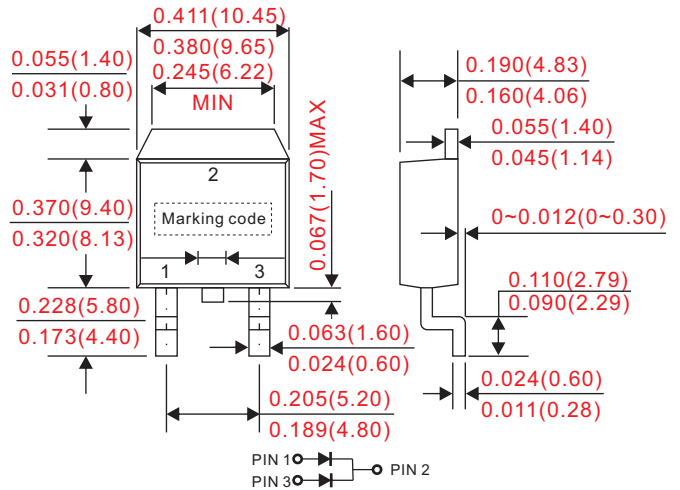

Dimensions in inches and (millimeters)

Parameter	Conditions	Symbol	MIN.	TYP.	MAX.	UNIT
Forward rectified current	See Fig.1	I_o			30	A
Forward surge current	8.3ms single half sine-wave superimposed on rate load (JEDEC method)	I_{FSM}			200	A
Reverse current	$V_R = V_{RRM}$ $T_A = 25^\circ\text{C}$	I_R			0.1	mA
	$V_R = V_{RRM}$ $T_A = 125^\circ\text{C}$				10	
Diode junction capacitance	f=1MHz and applied 4V DC reverse voltage	C_J		150		pF
Thermal resistance	Junction to ambient	$R_{\theta JA}$		30		°C/W
Storage temperature		T_{STG}	-55		+175	°C

Symbol	Marking code	Max. repetitive peak reverse voltage V_{RRM} (V)	Max. RMS voltage V_{RMS} (V)	Max. DC blocking voltage V_R (V)	Max. forward voltage @15A, $T_A = 25^\circ\text{C}$ V_F (V)	Max. forward voltage @15A, $T_A = 125^\circ\text{C}$ V_F (V)	Operating temperature T_J (°C)
MBRB3040CT	MBRB3040CT	40	28	40	0.70	0.57	-55 ~ +150
MBRB3045CT	MBRB3045CT	45	31.5	45			
MBRB3060CT	MBRB3060CT	60	42	60	0.79	0.70	
MBRB3065CT	MBRB3065CT	65	45.5	65			
MBRB30100CT	MBRB30100CT	100	70	100	0.81	0.71	-55 ~ +175
MBRB30150CT	MBRB30150CT	150	105	150	0.87	0.77	
MBRB30200CT	MBRB30200CT	200	140	200	0.90	0.80	

■ Rating and characteristic curves

Fig. 1 - Forward Current Derating Curve

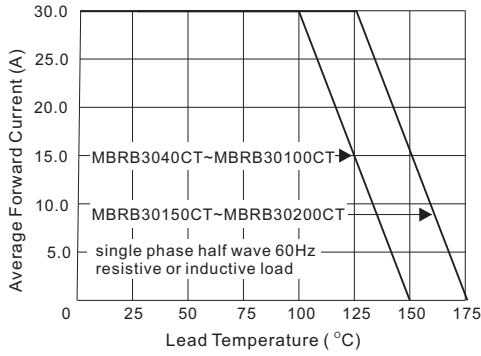

Fig. 2 - Maximum Non-Repetitive Peak Forward Surge Current

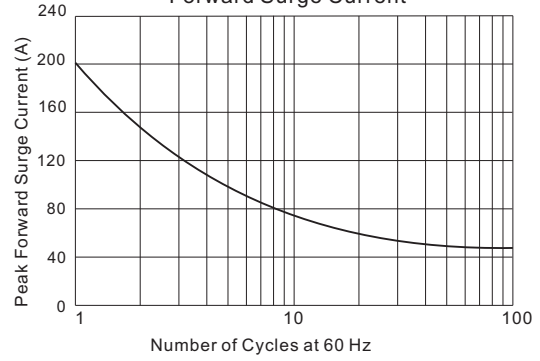

Fig. 3A - Typical Instantaneous Forward Characteristics

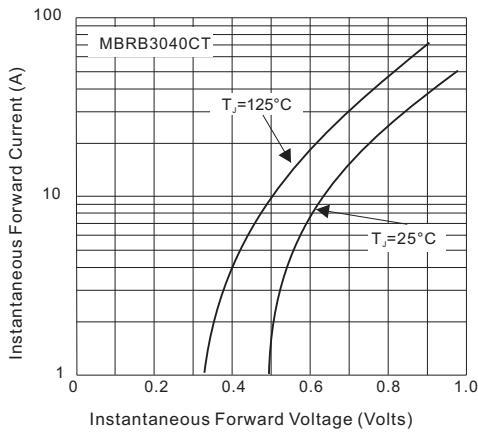

Fig. 3B - Typical Instantaneous Forward Characteristics

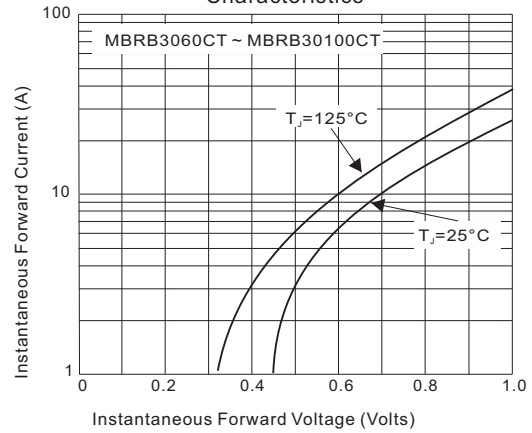

Fig. 3C - Typical Instantaneous Forward Characteristics

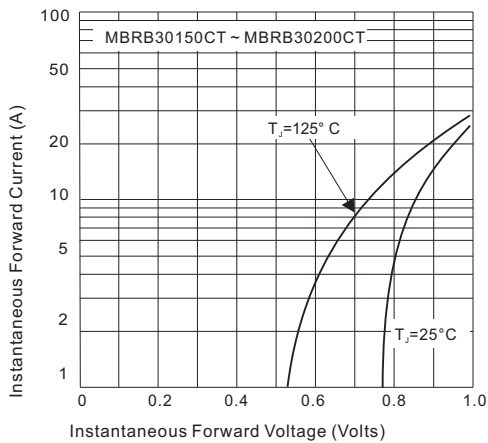
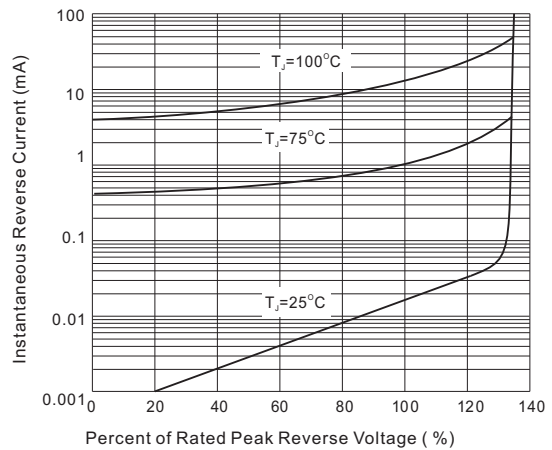
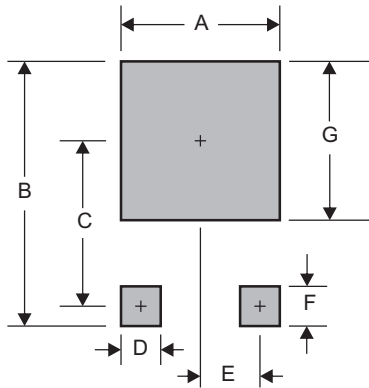

Fig. 4 - Typical Reverse Characteristics



■ D²PAK(TO-263) foot print



A	B	C	D	E	F	G
0.425 (10.80)	0.665 (16.90)	0.374 (9.50)	0.071 (1.80)	0.098 (2.50)	0.138 (3.50)	0.449 (11.40)

Dimensions in inches and (millimeters)

- CITC reserves the right to make changes to this document and its products and specifications at any time without notice.
- Customers should obtain and confirm the latest product information and specifications before final design, purchase or use.
- CITC makes no warranty, representation or guarantee regarding the suitability of its products for any particular purpose, nor does CITC assume any liability for application assistance or customer product design.
- CITC does not warrant or accept any liability with products which are purchased or used for any unintended or unauthorized application.
- No license is granted by implication or otherwise under any intellectual property rights of CITC.
- CITC products are not authorized for use as critical components in life support devices or systems without express written approval of CITC.