

IRG7PA19UPbF

Features

- Advanced Trench IGBT Technology
- Optimized for Sustain and Energy Recovery circuits in PDP applications
- Low $V_{CE(on)}$ and Energy per Pulse (E_{PULSE}^{TM}) for improved panel efficiency
- High repetitive peak current capability
- Lead Free package

Key Parameters		
$V_{CE\ min}$	360	V
$V_{CE(on)}\ typ.\ @\ I_C = 30A$	1.49	V
$I_{RP}\ max\ @\ T_C = 25^\circ C$	300	A
$T_J\ max$	150	$^\circ C$

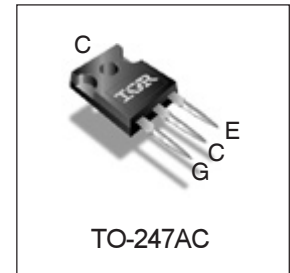
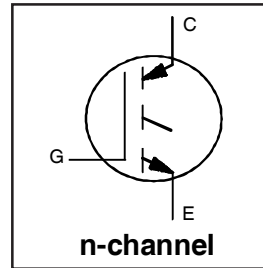

G	C	E
Gate	Collector	Emitter

Description

This IGBT is specifically designed for applications in Plasma Display Panels. This device utilizes advanced trench IGBT technology to achieve low $V_{CE(on)}$ and low E_{PULSE}^{TM} rating per silicon area which improve panel efficiency. Additional features are 150 $^\circ C$ operating junction temperature and high repetitive peak current capability. These features combine to make this IGBT a highly efficient, robust and reliable device for PDP applications.

Absolute Maximum Ratings

	Parameter	Max.	Units
V_{GE}	Gate-to-Emitter Voltage	± 30	V
$I_C @ T_C = 25^\circ C$	Continuous Collector Current, $V_{GE} @ 15V$	50	A
$I_C @ T_C = 100^\circ C$	Continuous Collector, $V_{GE} @ 15V$	26	
$I_{NOMINAL}$	Nominal Current	15	
$I_{RP} @ T_C = 25^\circ C$	Repetitive Peak Current ①	300	W
$P_D @ T_C = 25^\circ C$	Power Dissipation	104	
$P_D @ T_C = 100^\circ C$	Power Dissipation	42	$W/^\circ C$
	Linear Derating Factor	0.83	
T_J	Operating Junction and	-40 to + 150	$^\circ C$
T_{STG}	Storage Temperature Range		
	Soldering Temperature for 10 seconds	300	

Thermal Resistance

	Parameter	Typ.	Max.	Units
$R_{\theta JC}$	Junction-to-Case ②	—	1.2	$^\circ C/W$
$R_{\theta CS}$	Case-to-Sink, flat, greased surface	0.24	—	
$R_{\theta JA}$	Junction-to-Ambient, typical socket mount	—	40	
Wt	Weight	6.0	—	g

Electrical Characteristics @ T_J = 25°C (unless otherwise specified)

	Parameter	Min.	Typ.	Max.	Units	Conditions
BV _{CES}	Collector-to-Emitter Breakdown Voltage	360	—	—	V	V _{GE} = 0V, I _{CE} = 250μA
ΔBV _{CES} /ΔT _J	Breakdown Voltage Temp. Coefficient	—	0.34	—	V/°C	Reference to 25°C, I _{CE} = 1mA
V _{CE(on)}	Static Collector-to-Emitter Voltage	—	1.26	1.52	V	V _{GE} = 15V, I _{CE} = 15A ③
		—	1.41	—		V _{GE} = 15V, I _{CE} = 25A ③
		—	1.49	—		V _{GE} = 15V, I _{CE} = 30A ③
		—	1.65	—		V _{GE} = 15V, I _{CE} = 40A ③
		—	2.12	—		V _{GE} = 15V, I _{CE} = 70A ③
		—	2.93	—		V _{GE} = 15V, I _{CE} = 120A ③
		—	1.51	—		V _{GE} = 15V, I _{CE} = 25A, T _J = 150°C ③
V _{GE(th)}	Gate Threshold Voltage	2.2	—	4.7	V	V _{CE} = V _{GE} , I _{CE} = 1.0mA
ΔV _{GE(th)} /ΔT _J	Gate Threshold Voltage Coefficient	—	-10	—	mV/°C	
I _{CES}	Collector-to-Emitter Leakage Current	—	1.0	20	μA	V _{CE} = 360V, V _{GE} = 0V
		—	35	200		V _{CE} = 360V, V _{GE} = 0V, T _J = 125°C
		—	130	—		V _{CE} = 360V, V _{GE} = 0V, T _J = 150°C
I _{GES}	Gate-to-Emitter Forward Leakage	—	—	100	nA	V _{GE} = 30V
	Gate-to-Emitter Reverse Leakage	—	—	-100	nA	V _{GE} = -30V
g _{fe}	Forward Transconductance	—	62	—	S	V _{CE} = 25V, I _{CE} = 25A
Q _g	Total Gate Charge	—	38	—	nC	V _{CE} = 200V, I _C = 25A, V _{GE} = 15V ③
Q _{gc}	Gate-to-Collector Charge	—	12	—		
t _{d(on)}	Turn-On delay time	—	15	—		
t _r	Rise time	—	21	—	ns	R _G = 10Ω, L = 200μH, L _S = 150nH T _J = 25°C
t _{d(off)}	Turn-Off delay time	—	68	—		
t _f	Fall time	—	88	—		
t _{d(on)}	Turn-On delay time	—	15	—	ns	I _C = 25A, V _{CC} = 196V R _G = 10Ω, L = 200μH, L _S = 150nH T _J = 150°C
t _r	Rise time	—	23	—		
t _{d(off)}	Turn-Off delay time	—	84	—		
t _f	Fall time	—	191	—		
t _{st}	Shoot Through Blocking Time	100	—	—	ns	V _{CC} = 240V, V _{GE} = 15V, R _G = 5.1Ω
E _{PULSE}	Energy per Pulse	—	854	—	μJ	L = 220nH, C = 0.40μF, V _{GE} = 15V V _{CC} = 240V, R _G = 5.1Ω, T _J = 25°C
		—	1083	—		L = 220nH, C = 0.40μF, V _{GE} = 15V V _{CC} = 240V, R _G = 5.1Ω, T _J = 100°C
ESD	Human Body Model	Class 1C (Per JEDEC standard JESD22-A114)				
	Machine Model	Class B (Per EIA/JEDEC standard EIA/JESD22-A115)				
C _{ies}	Input Capacitance	—	1100	—	pF	V _{GE} = 0V
C _{oes}	Output Capacitance	—	57	—		V _{CE} = 30V
C _{res}	Reverse Transfer Capacitance	—	30	—		f = 1.0MHz
L _C	Internal Collector Inductance	—	4.5	—	nH	Between lead, 6mm (0.25in.)
L _E	Internal Emitter Inductance	—	7.5	—		from package and center of die contact

Notes:

- ① Half sine wave with duty cycle ≤ 0.05, t_{on} = 2μsec.
- ② R_q is measured at T_J of approximately 90°C.
- ③ Pulse width ≤ 400μs; duty cycle ≤ 2%.

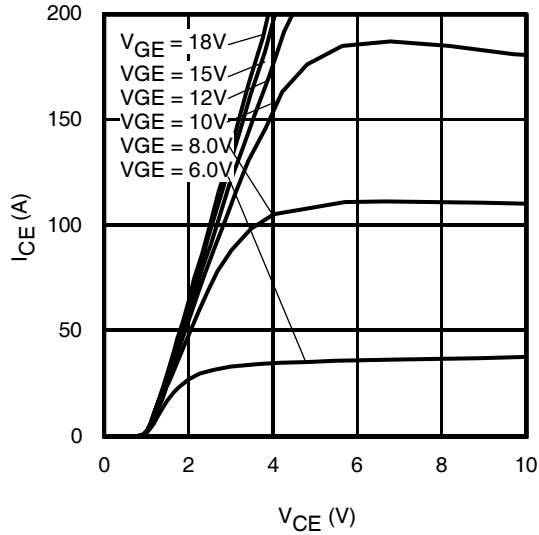

Fig 1. Typical Output Characteristics @ 25°C

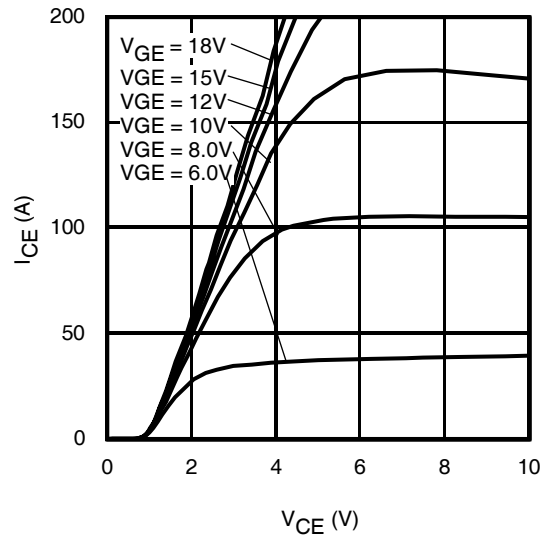

Fig 2. Typical Output Characteristics @ 75°C

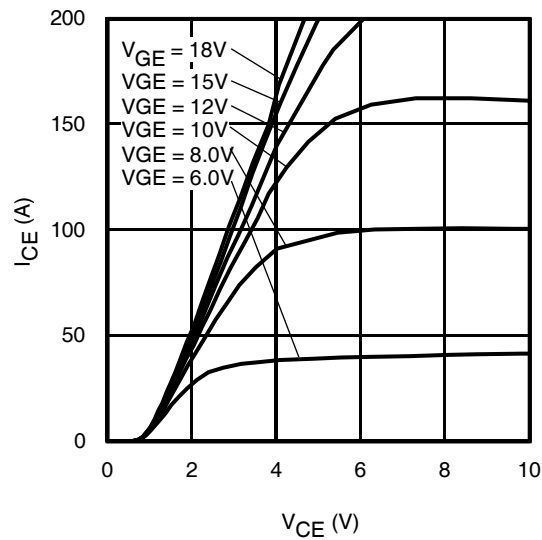

Fig 3. Typical Output Characteristics @ 125°C

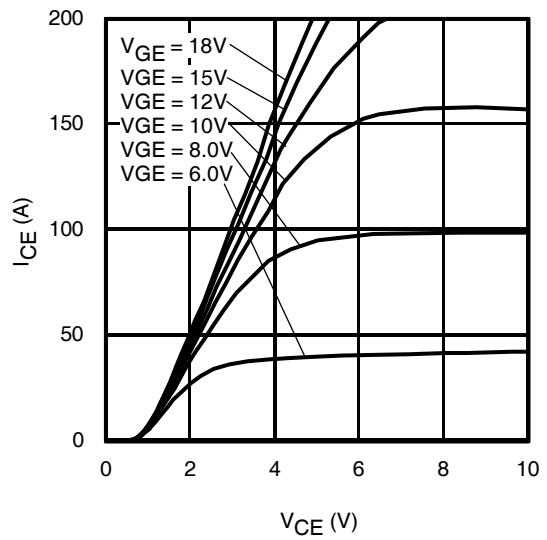

Fig 4. Typical Output Characteristics @ 150°C

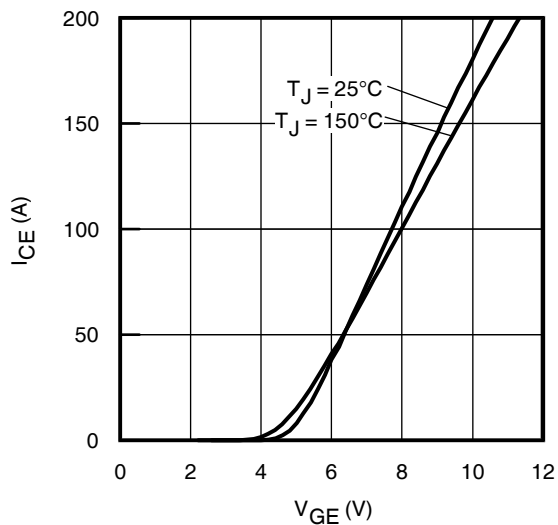

Fig 5. Typical Transfer Characteristics

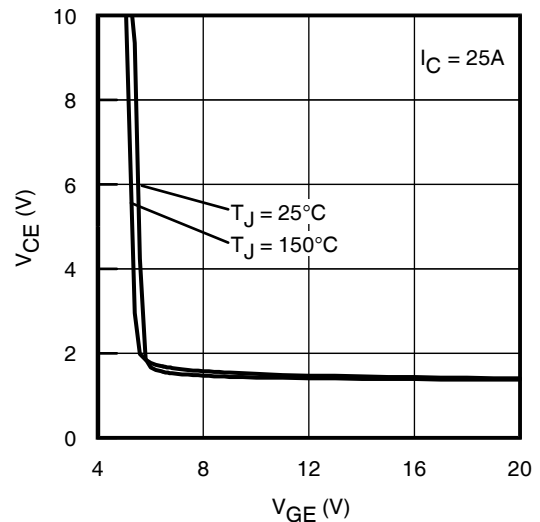

Fig 6. $V_{CE(ON)}$ vs. Gate Voltage

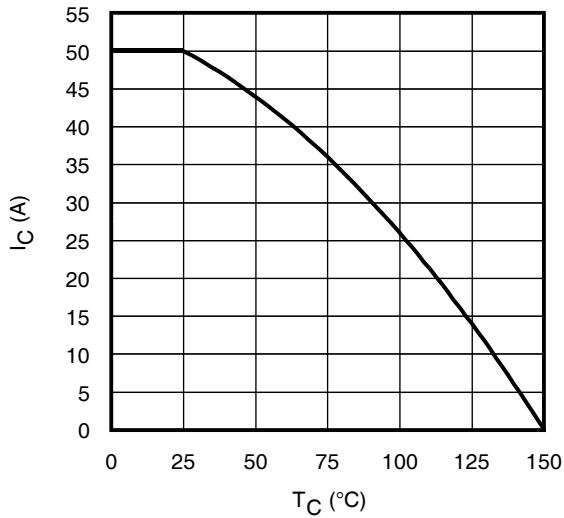

Fig 7. Maximum Collector Current vs. Case Temperature

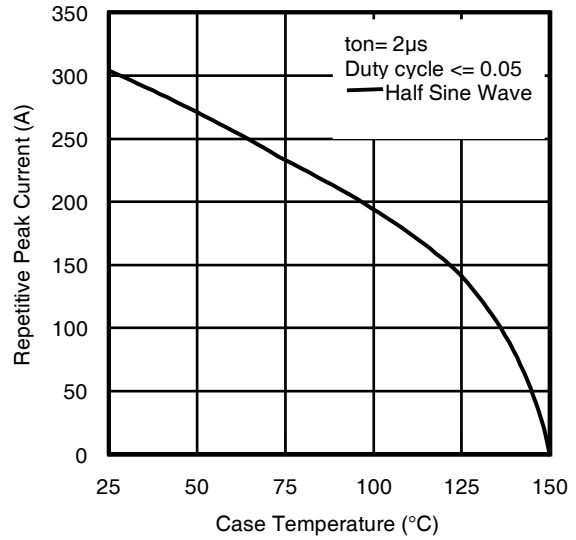

Fig 8. Typical Repetitive Peak Current vs. Case Temperature

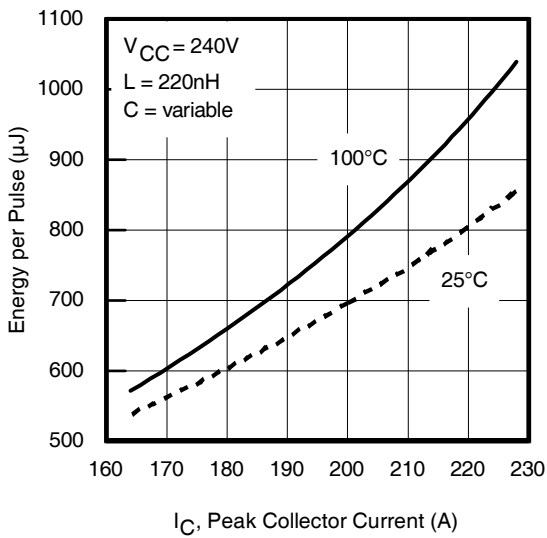

Fig 9. Typical E_{PULSE} vs. Collector Current

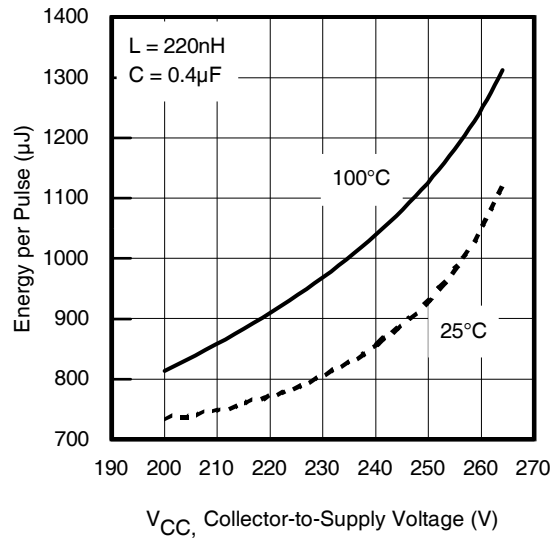

Fig 10. Typical E_{PULSE} vs. Collector-to-Supply Voltage

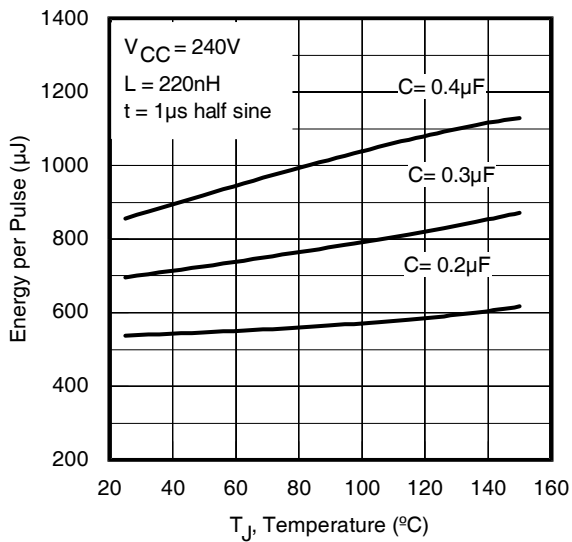

Fig 11. E_{PULSE} vs. Temperature

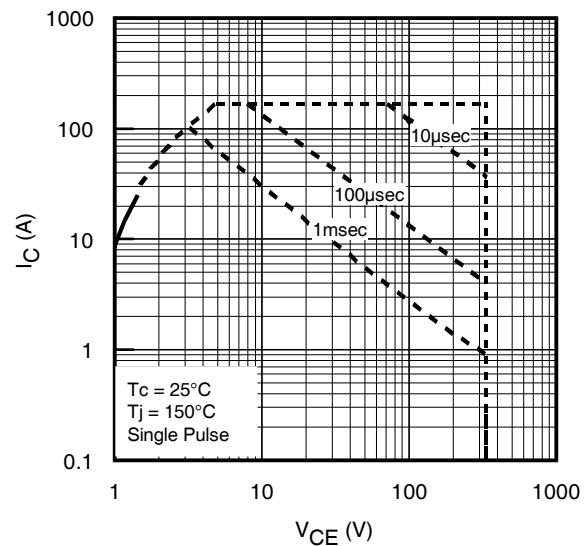

Fig 12. Forward Bias Safe Operating Area

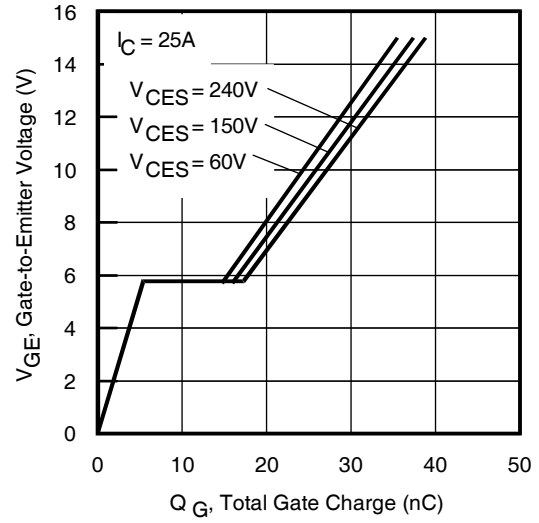
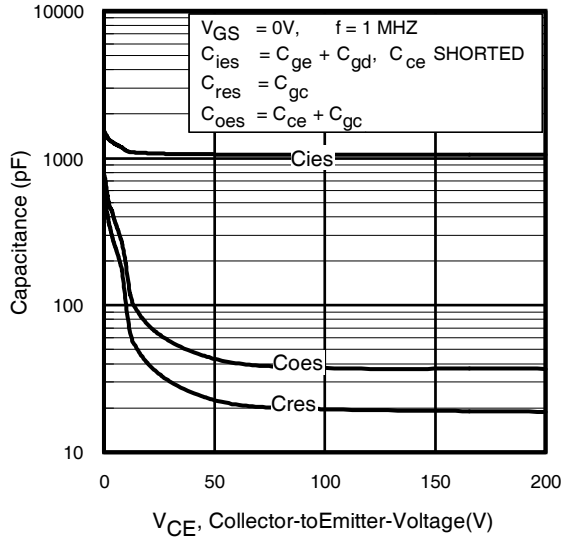

Fig 13. Typical Capacitance vs. Collector-to-Emitter Voltage

Fig 14. Typical Gate Charge vs. Gate-to-Emitter Voltage

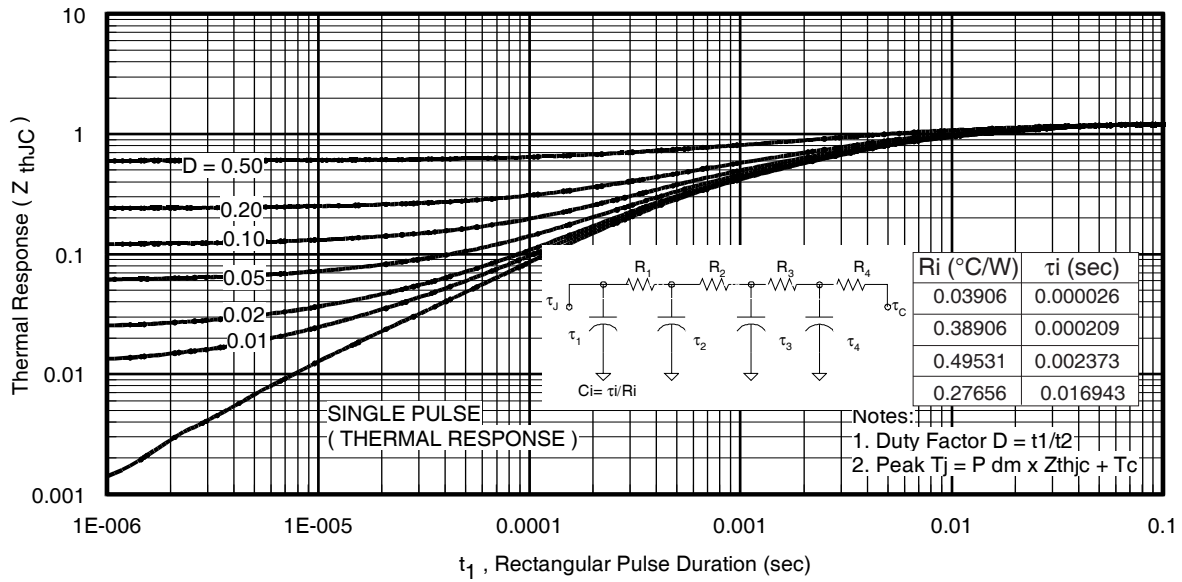

Fig 15. Maximum Effective Transient Thermal Impedance, Junction-to-Case

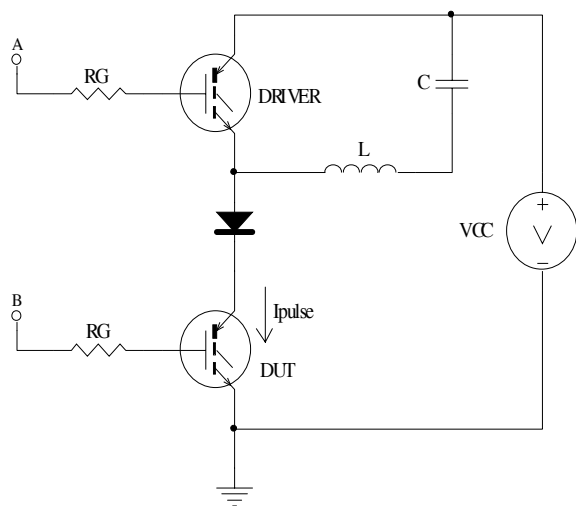

Fig 16a. t_{st} and E_{PULSE} Test Circuit

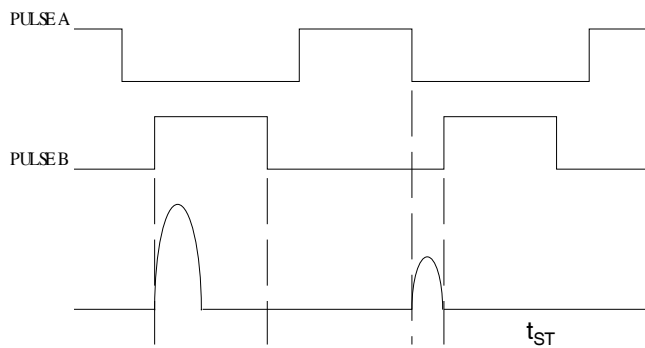

Fig 16b. t_{st} Test Waveforms

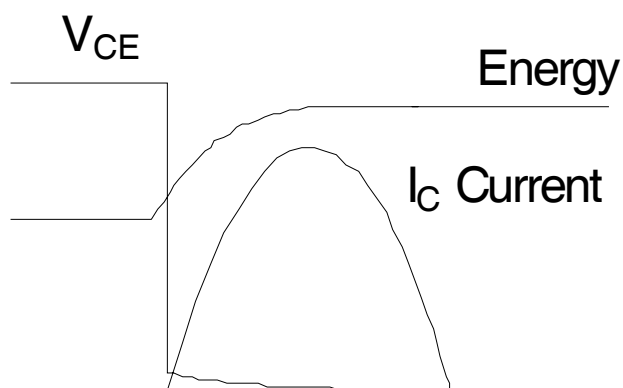
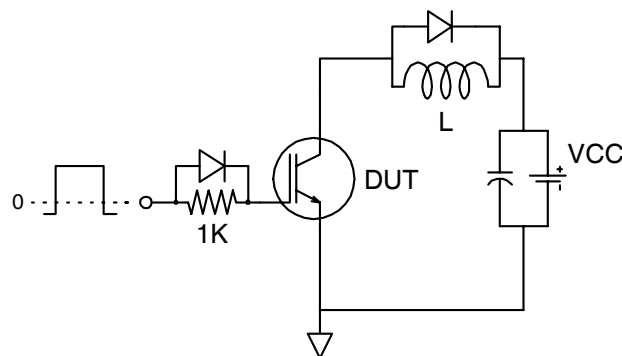
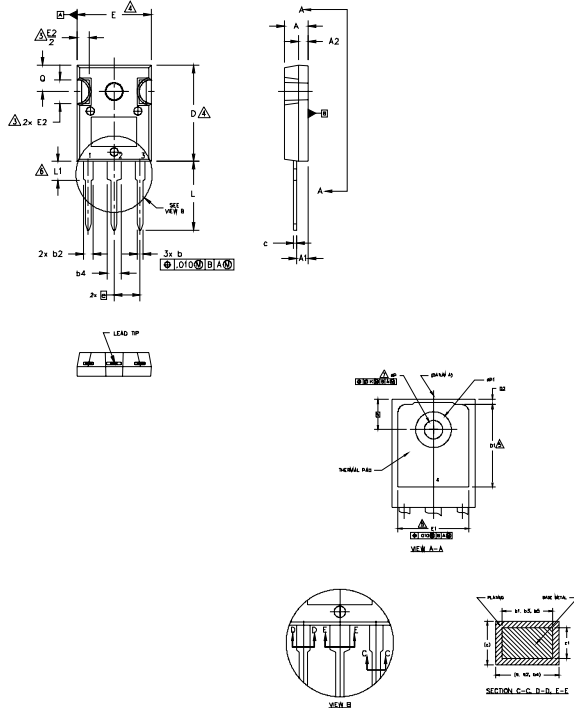

Fig 16c. E_{PULSE} Test Waveforms



TO-247AC Package Outline

Dimensions are shown in millimeters (inches)



NOTES:

1. DIMENSIONING AND TOLERANCING AS PER ASME Y14.5M 1994.
2. DIMENSIONS ARE SHOWN IN INCHES.
3. CONTOUR OF SLOT OPTIONAL.
4. DIMENSION D & E DO NOT INCLUDE MOLD FLASH. MOLD FLASH SHALL NOT EXCEED .005" (0.127) PER SIDE. THESE DIMENSIONS ARE MEASURED AT THE OUTERMOST EXTREMES OF THE PLASTIC BODY.
5. THERMAL PAD CONTOUR OPTIONAL WITHIN DIMENSIONS D1 & E1.
6. LEAD FINISH UNCONTROLLED IN L1.
7. ØP TO HAVE A MAXIMUM DRAFT ANGLE OF 1.5 ° TO THE TOP OF THE PART WITH A MAXIMUM HOLE DIAMETER OF .154 INCH.
8. OUTLINE CONFORMS TO JEDEC OUTLINE TO-247AC .

SYMBOL	DIMENSIONS				NOTES
	INCHES		MILLIMETERS		
	MIN.	MAX.	MIN.	MAX.	
A	.183	.209	4.65	5.31	
A1	.087	.102	2.21	2.59	
A2	.059	.098	1.50	2.49	
b	.039	.055	0.99	1.40	
b1	.039	.053	0.99	1.35	
b2	.065	.094	1.65	2.39	
b3	.065	.092	1.65	2.34	
b4	.102	.135	2.59	3.43	
b5	.102	.133	2.59	3.38	
c	.015	.035	0.38	0.89	
c1	.015	.033	0.38	0.84	
D	.776	.815	19.71	20.70	4
D1	.515	-	13.08	-	5
D2	.020	.053	0.51	1.35	
E	.602	.625	15.29	15.87	4
E1	.530	-	13.46	-	
E2	.178	.216	4.52	5.49	
e	.215 BSC		5.46 BSC		
Øk	.010		0.25		
L	.559	.634	14.20	16.10	
L1	.146	.169	3.71	4.29	
ØP	.140	.144	3.56	3.66	
ØPI	-	.291	-	7.39	
Q	.209	.224	5.31	5.69	
S	.217 BSC		5.51 BSC		

LEAD ASSIGNMENTS

HEXFET

- 1.- GATE
- 2.- DRAIN
- 3.- SOURCE
- 4.- DRAIN

IGBTs, CoPACK

- 1.- GATE
- 2.- COLLECTOR
- 3.- EMITTER
- 4.- COLLECTOR

DIODES

- 1.- ANODE/OPEN
- 2.- CATHODE
- 3.- ANODE

TO-247AC Part Marking Information

EXAMPLE: THIS IS AN IRFPE30
WITH ASSEMBLY
LOT CODE 5657
ASSEMBLED ON WW 35, 2001
IN THE ASSEMBLY LINE "H"

Note: "P" in assembly line position
indicates "Lead-Free"

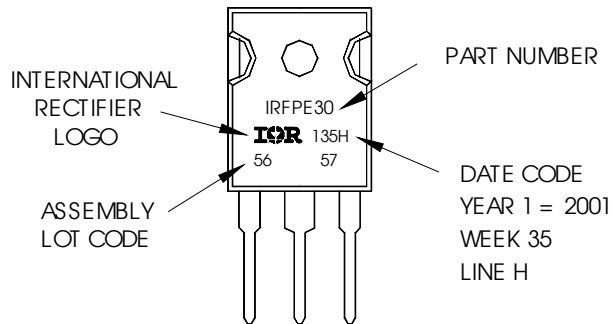

TO-247AC package is not recommended for Surface Mount Application.

Note: For the most current drawing please refer to IR website at <http://www.irf.com/package/>

Data and specifications subject to change without notice.
This product has been designed for the Industrial market.
Qualification Standards can be found on IR's Web site.