

Features

- **Very Low Leakage Current**
- Single and Dual Diode
- Surface Mount Package Ideally Suited for Automatic Insertion
- For General Purpose Switching Applications
- Plastic Material – UL Recognition Flammability Classification 94V-0

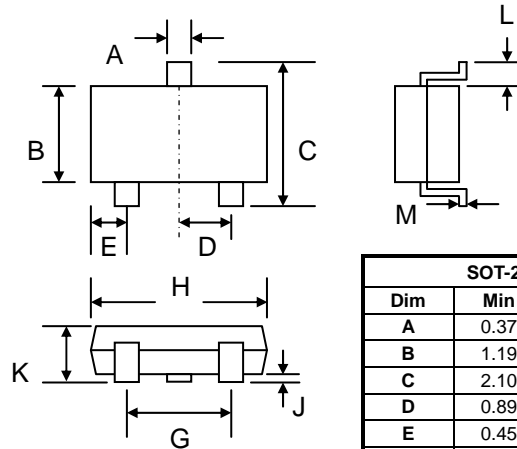

SOT-23		
Dim	Min	Max
A	0.37	0.51
B	1.19	1.40
C	2.10	2.50
D	0.89	1.05
E	0.45	0.61
G	1.78	2.05
H	2.65	3.05
J	0.013	0.15
K	0.89	1.10
L	0.45	0.61
M	0.076	0.178
All Dimensions in mm		

Mechanical Data

- Case: SOT-23, Molded Plastic
- Terminals: Plated Leads Solderable per MIL-STD-202, Method 208
- Polarity: See Diagrams Below
- Weight: 0.008 grams (approx.)
- Marking: Device Code, See Page 3
- Mounting Position: Any
- **Lead Free: For RoHS / Lead Free Version, Add "-LF" Suffix to Part Number, See Page 4**

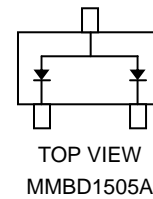
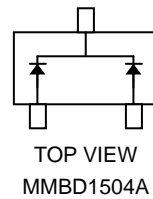
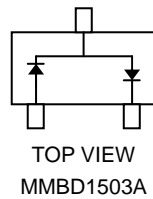
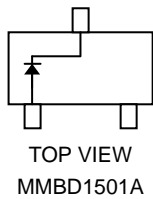

Maximum Ratings @ $T_A=25^\circ\text{C}$ unless otherwise specified

Characteristic	Symbol	Value	Unit
Peak Repetitive Reverse Voltage Working Peak Reverse Voltage DC Blocking Voltage	V_{RRM} V_{RWM} V_R	200	V
Forward Continuous Current	I_F	200	mA
Non-Repetitive Peak Forward Surge Current @ $t = 1.0\mu\text{s}$ @ $t = 1.0\text{s}$	I_{FSM}	2.0 1.0	A
Operating and Storage Temperature Range	T_J, T_{STG}	-55 to +150	$^\circ\text{C}$

Thermal Characteristics

Characteristic	Symbol	Value	Unit
Power Dissipation (Note 1)	P_D	350	mW
Thermal Resistance, Junction to Ambient (Note 1)	R_{JA}	357	$^\circ\text{C/W}$

Note: 1. Mounted on FR-4 PC board with minimum recommended pad layout.

Electrical Characteristics @ $T_A=25^\circ\text{C}$ unless otherwise specified

Characteristic	Symbol	Min.	Typ.	Max.	Unit
Reverse Breakdown Voltage @ $I_R = 5.0\mu\text{A}$	$V_{(BR)}$	200			V
Forward Voltage Drop @ $I_F = 1.0\text{mA}$ @ $I_F = 10\text{mA}$ @ $I_F = 100\text{mA}$ @ $I_F = 200\text{mA}$	V_{FM}		0.62 0.72 0.83 0.87	0.72 0.83 0.93 1.10	V
Peak Reverse Leakage Current @ $V_R = 125\text{V}$ @ $V_R = 180\text{V}$	I_{RM}			1.0 10	nA
Diode Capacitance ($V_R = 0\text{V}$, $f = 1.0\text{MHz}$)	C_D			4.0	pF

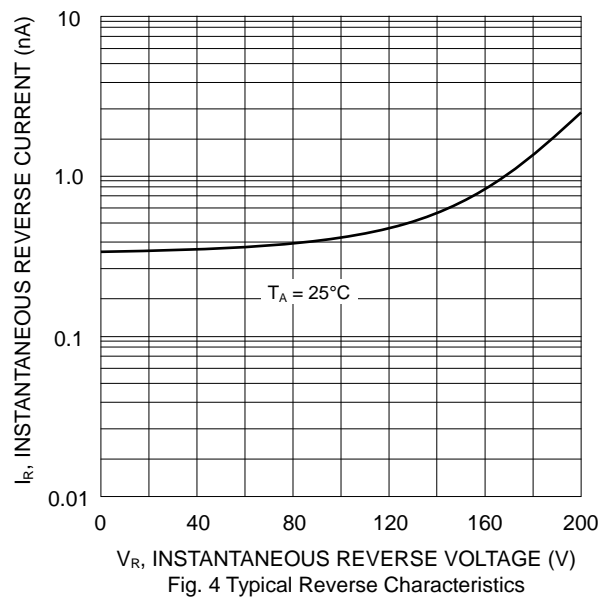
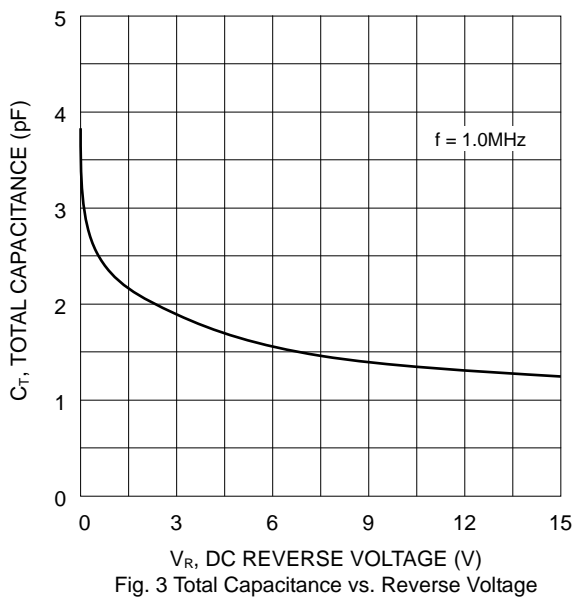
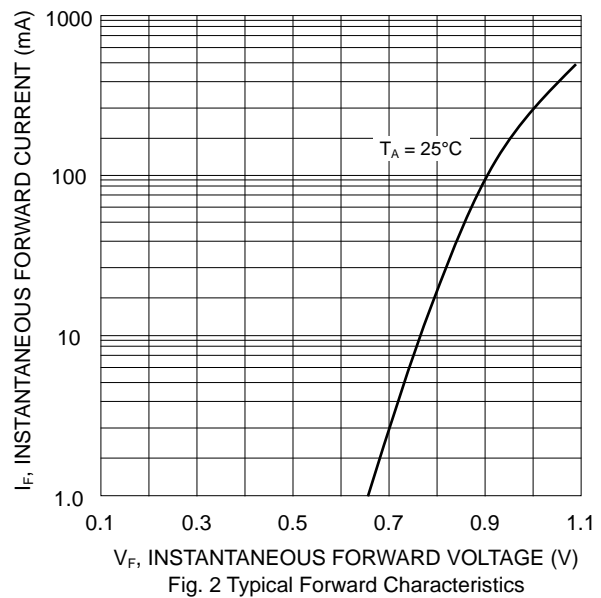
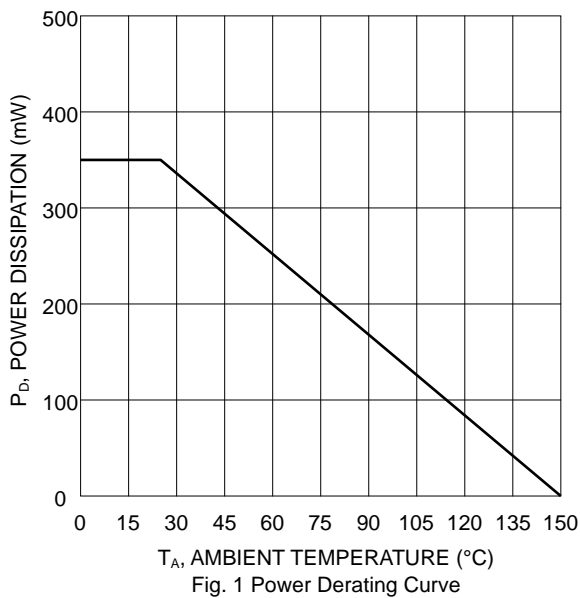

MARKING INFORMATION

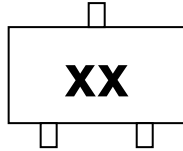

xx = Device Code, See Table Below

MMBD1501A	MMBD1503A	MMBD1504A	MMBD1505A
A11	A13	A14	A15

RECOMMENDED FOOTPRINT

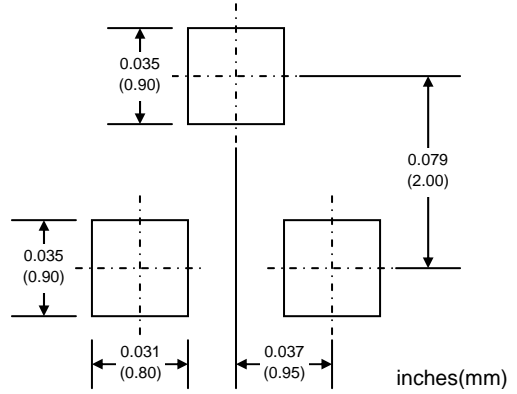

PACKAGING INFORMATION

TAPE & REEL

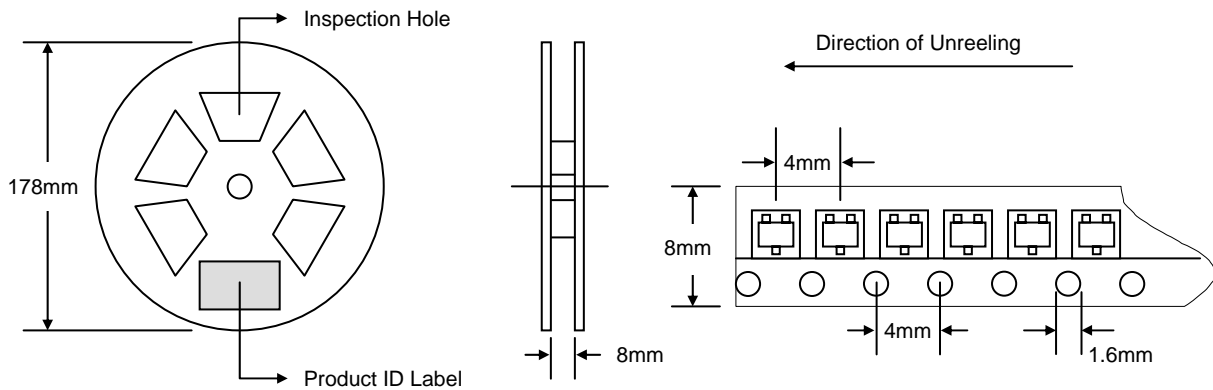

Reel Diameter (mm)	Quantity (PCS)	Inner Box Size L x W x H (mm)	Quantity (PCS)	Carton Size L x W x H (mm)	Quantity (PCS)	Approx. Gross Weight (KG)
178	3,000	187 x 187 x 65	15,000	390 x 240 x 420	150,000	10.0

Note: 1. Anti-static plastic reel, white, water clear or blue color. Inspection hole might be varied in different alignment.
2. Components are packed in accordance with EIA standard 481-1 and 481-2.

ORDERING INFORMATION

Product No.	Package Type	Shipping Quantity
MMBD1501A-T1	SOT-23	3000/Tape & Reel
MMBD1503A-T1	SOT-23	3000/Tape & Reel
MMBD1504A-T1	SOT-23	3000/Tape & Reel
MMBD1505A-T1	SOT-23	3000/Tape & Reel

1. Shipping quantity given is for minimum packing quantity only. For minimum order quantity, please consult the Sales Department.
2. **To order RoHS / Lead Free version (with Lead Free finish), add "-LF" suffix to part number above. For example, MMBD1501A-T1-LF.**

WON-TOP ELECTRONICS and  are registered trademarks of Won-Top Electronics Co., Ltd (WTE). WTE has checked all information carefully and believes it to be correct and accurate. However, WTE cannot assume any responsibility for inaccuracies. Furthermore, this information does not give the purchaser of semiconductor devices any license under patent rights to manufacturer. WTE reserves the right to change any or all information herein without further notice.

WARNING: DO NOT USE IN LIFE SUPPORT EQUIPMENT. WTE power semiconductor products are not authorized for use as critical components in life support devices or systems without the express written approval.

Won-Top Electronics Co., Ltd.

No. 44 Yu Kang North 3rd Road,

Chine Chen Dist., Kaohsiung 806, Taiwan

Phone: 886-7-822-5408 or 886-7-822-5410

Fax: 886-7-822-5417

Email: sales@wontop.com

Internet: <http://www.wontop.com>

We power your everyday.