

Features

- Low Forward Voltage
- Epitaxial Construction with Oxide Passivation
- Guard Ring for Transient and ESD Protection
- Surge Overload Rating to 200A Peak
- Low Power Loss, High Efficiency
- Fast Switching
- For Use in Low Voltage, High Frequency Inverters, Free Wheeling, and Switching Power Supplies

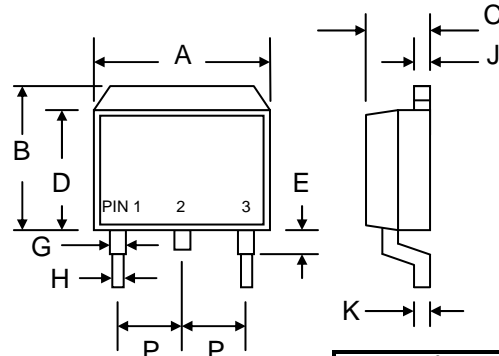

Mechanical Data

- Case: D²PAK/TO-263, Molded Plastic
- Terminals: Plated Leads Solderable per MIL-STD-202, Method 208
- Polarity: See Diagram
- Weight: 1.7 grams (approx.)
- Mounting Position: Any
- Marking: Type Number
- **Lead Free: For RoHS / Lead Free Version, Add "-LF" Suffix to Part Number, See Page 4**

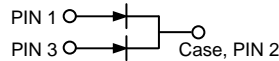

D ² PAK/TO-263		
Dim	Min	Max
A	9.80	10.40
B	9.60	10.60
C	4.40	4.80
D	8.50	9.10
E	—	2.80
G	1.00	1.40
H	—	0.99
J	1.20	1.40
K	0.30	0.70
P	2.35	2.75
All Dimensions in mm		

Maximum Ratings and Electrical Characteristics @T_A=25°C unless otherwise specified

Single Phase, half wave, 60Hz, resistive or inductive load. For capacitive load, derate current by 20%.

Characteristic	Symbol	SB	SB	SB	SB	SB	SB	SB	SB	Unit
		3020DC	3030DC	3040DC	3045DC	3050DC	3060DC	3080DC	30100DC	
Peak Repetitive Reverse Voltage Working Peak Reverse Voltage DC Blocking Voltage	V _{RRM} V _{RWM} V _R	20	30	40	45	50	60	80	100	V
RMS Reverse Voltage	V _{R(RMS)}	14	21	28	32	35	42	56	70	V
Average Rectified Output Current @T _C = 100°C	I _O	30 15								A
Non-Repetitive Peak Forward Surge Current 8.3ms Single Half Sine-Wave Superimposed on Rated Load (JEDEC Method)	I _{FSM}	200								A
Forward Voltage per diode @I _F = 15A, T _J = 25°C @I _F = 15A, T _J = 125°C	V _{FM}	0.62 0.57			0.75 0.65		0.85 0.75			V
Peak Reverse Current At Rated DC Blocking Voltage	I _{RM}	1.0 20								mA
Typical Junction Capacitance (Note 1)	C _J	750			500					pF
Thermal Resistance Junction to Ambient (Note 2) Thermal Resistance Junction to Case (Note 2)	R _{JA} R _{JC}	50 1.5								°C/W
Operating and Storage Temperature Range	T _J , T _{STG}	-55 to +150								°C

Note: 1. Measured at 1.0 MHz and applied reverse voltage of 4.0V D.C.
2. Mounted on FR-4 PCB with minimum recommended pad layout per diode.

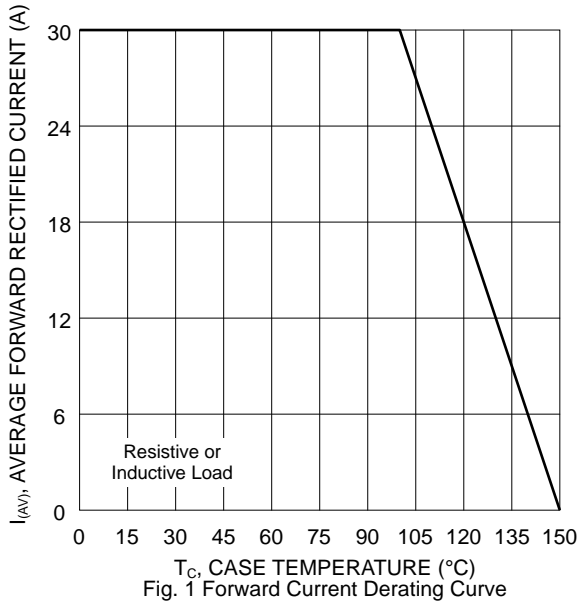

Fig. 1 Forward Current Derating Curve

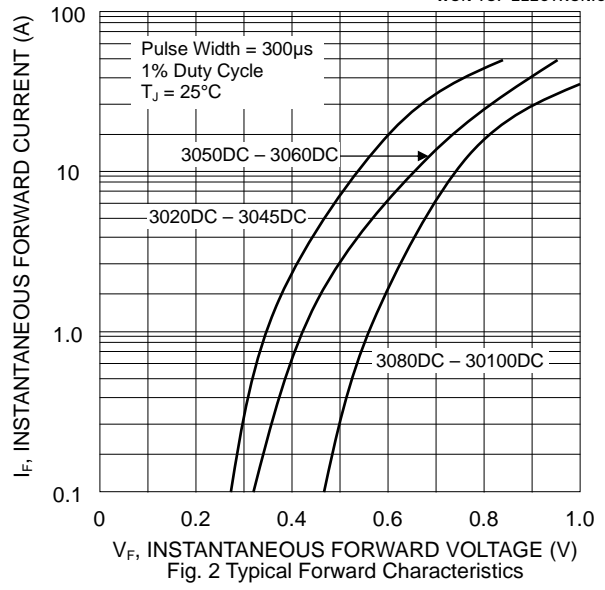

Fig. 2 Typical Forward Characteristics

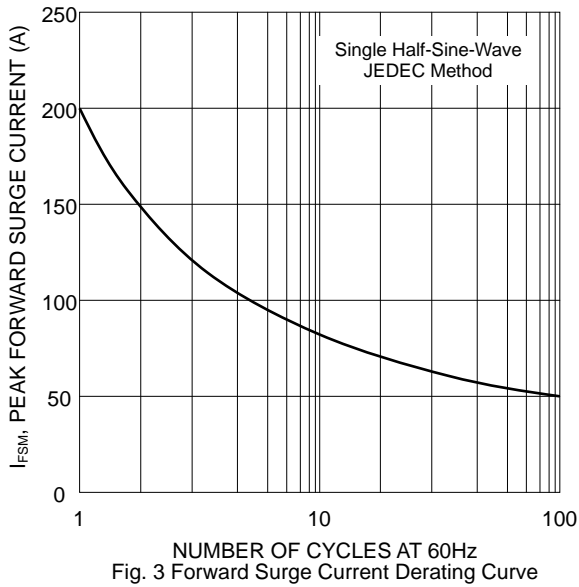

Fig. 3 Forward Surge Current Derating Curve

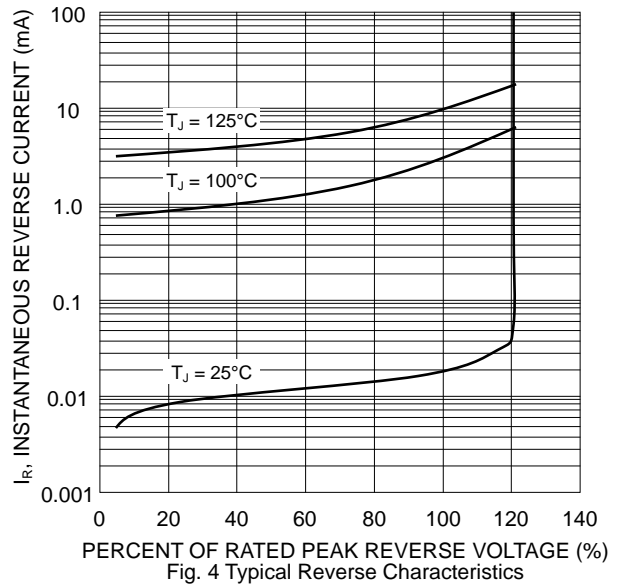

Fig. 4 Typical Reverse Characteristics

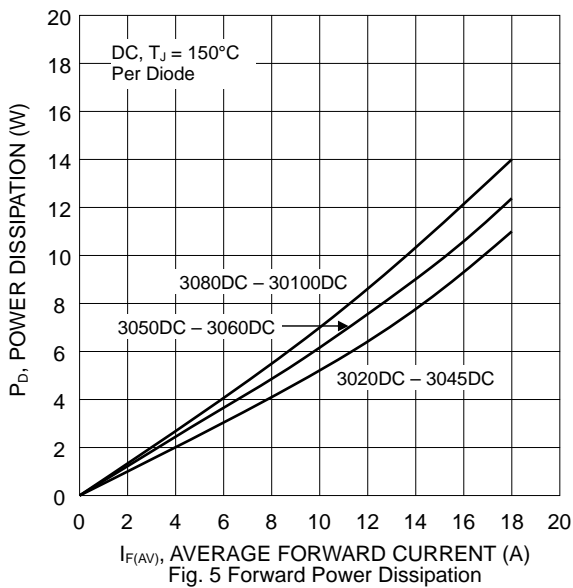

Fig. 5 Forward Power Dissipation

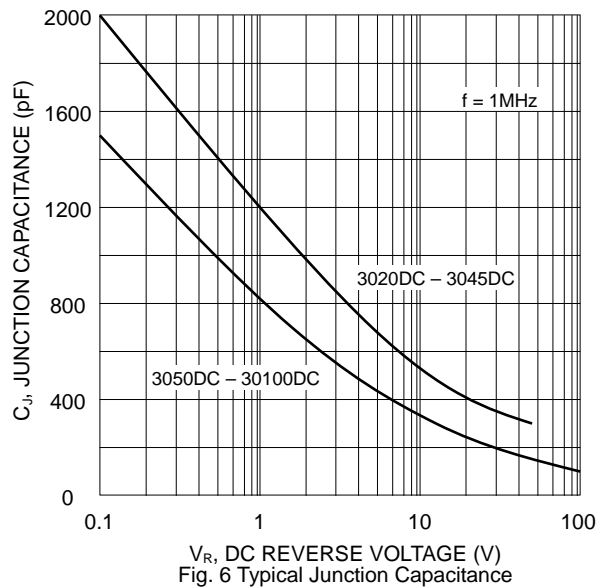
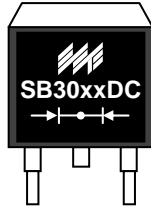

Fig. 6 Typical Junction Capacitance

MARKING INFORMATION



SB30xxDC = Device Number
 xx = 20, 30, 40, 45, 50, 60, 80 or 100
 Polarity = As Marked on Body

RECOMMENDED FOOTPRINT

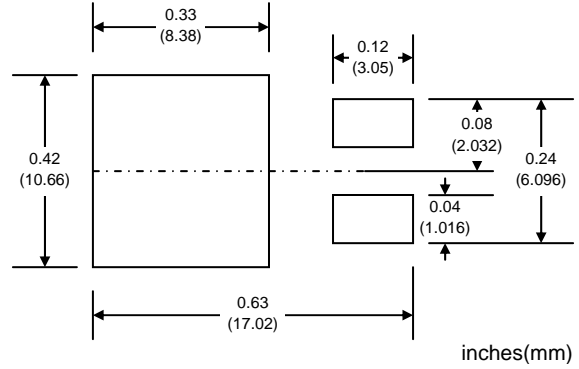

PACKAGING INFORMATION

TAPE & REEL

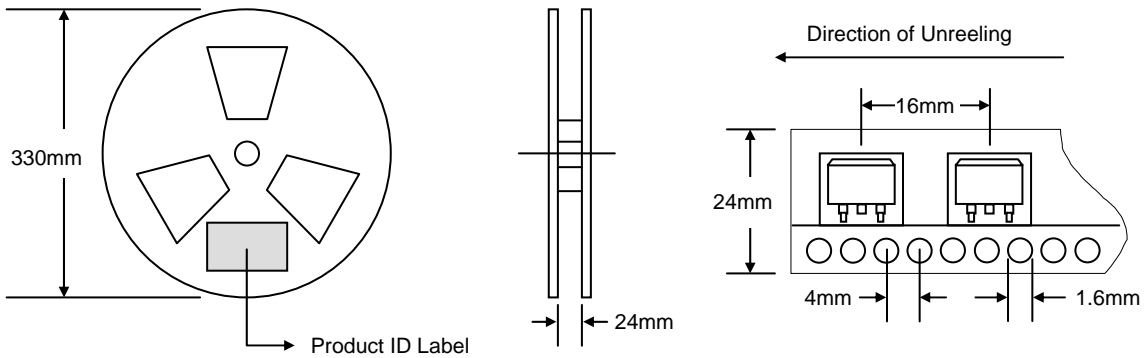

Reel Diameter (mm)	Quantity (PCS)	Inner Box Size L x W x H (mm)	Quantity (PCS)	Carton Size L x W x H (mm)	Quantity (PCS)	Approx. Gross Weight (KG)
330	800	340 x 337 x 45	800	370 x 370 x 420	6,400	15.0

Note: 1. Paper reel, white or gray color.
 2. Components are packed in accordance with EIA standard 481-1 and 481-2.

ORDERING INFORMATION

Product No.	Package Type	Shipping Quantity
SB3020DC-T3	D ² PAK	800/Tape & Reel
SB3030DC-T3	D ² PAK	800/Tape & Reel
SB3040DC-T3	D ² PAK	800/Tape & Reel
SB3045DC-T3	D ² PAK	800/Tape & Reel
SB3050DC-T3	D ² PAK	800/Tape & Reel
SB3060DC-T3	D ² PAK	800/Tape & Reel
SB3080DC-T3	D ² PAK	800/Tape & Reel
SB30100DC-T3	D ² PAK	800/Tape & Reel

1. Shipping quantity given is for minimum packing quantity only. For minimum order quantity, please consult the Sales Department.
2. **To order RoHS / Lead Free version (with Lead Free finish), add "-LF" suffix to part number above. For example, SB3020DC-T3-LF.**

WON-TOP ELECTRONICS and  are registered trademarks of Won-Top Electronics Co., Ltd (WTE). WTE has checked all information carefully and believes it to be correct and accurate. However, WTE cannot assume any responsibility for inaccuracies. Furthermore, this information does not give the purchaser of semiconductor devices any license under patent rights to manufacturer. WTE reserves the right to change any or all information herein without further notice.

WARNING: DO NOT USE IN LIFE SUPPORT EQUIPMENT. WTE power semiconductor products are not authorized for use as critical components in life support devices or systems without the express written approval.

Won-Top Electronics Co., Ltd.
No. 44 Yu Kang North 3rd Road,
Chine Chen Dist., Kaohsiung 806, Taiwan
Phone: 886-7-822-5408 or 886-7-822-5410
Fax: 886-7-822-5417
Email: sales@wontop.com
Internet: http://www.wontop.com

We power your everyday.