

### Features

- Low Forward Voltage
- Epitaxial Construction with Oxide Passivation
- Guard Ring for Transient and ESD Protection
- Surge Overload Rating to 200A Peak
- Low Power Loss, High Efficiency
- Fast Switching
- For Use in Low Voltage, High Frequency Inverters, Free Wheeling, and Switching Power Supplies

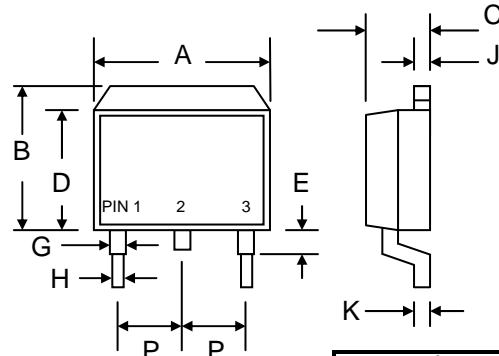

### Mechanical Data

- Case: D<sup>2</sup>PAK/TO-263, Molded Plastic
- Terminals: Plated Leads Solderable per MIL-STD-202, Method 208
- Polarity: See Diagram
- Weight: 1.7 grams (approx.)
- Mounting Position: Any
- Marking: Type Number
- **Lead Free: For RoHS / Lead Free Version, Add "-LF" Suffix to Part Number, See Page 4**

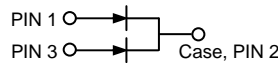

D <sup>2</sup> PAK/TO-263		
Dim	Min	Max
A	9.80	10.40
B	9.60	10.60
C	4.40	4.80
D	8.50	9.10
E	—	2.80
G	1.00	1.40
H	—	0.99
J	1.20	1.40
K	0.30	0.70
P	2.35	2.75
All Dimensions in mm		

### Maximum Ratings and Electrical Characteristics @T<sub>A</sub>=25°C unless otherwise specified

Single Phase, half wave, 60Hz, resistive or inductive load. For capacitive load, derate current by 20%.

Characteristic	Symbol	SB	SB	SB	SB	SB	SB	SB	SB	Unit
		2520DC	2530DC	2540DC	2545DC	2550DC	2560DC	2580DC	25100DC	
Peak Repetitive Reverse Voltage Working Peak Reverse Voltage DC Blocking Voltage	V <sub>RRM</sub> V <sub>RWM</sub> V <sub>R</sub>	20	30	40	45	50	60	80	100	V
RMS Reverse Voltage	V <sub>R(RMS)</sub>	14	21	28	32	35	42	56	70	V
Average Rectified Output Current @T <sub>C</sub> = 100°C	I <sub>O</sub>	25 12.5								A
Non-Repetitive Peak Forward Surge Current 8.3ms Single Half Sine-Wave Superimposed on Rated Load (JEDEC Method)	I <sub>FSM</sub>	200								A
Forward Voltage per diode @I <sub>F</sub> = 12.5A, T <sub>J</sub> = 25°C @I <sub>F</sub> = 12.5A, T <sub>J</sub> = 125°C	V <sub>FM</sub>	0.62 0.57			0.75 0.65		0.85 0.75			V
Peak Reverse Current At Rated DC Blocking Voltage @T <sub>J</sub> = 25°C @T <sub>J</sub> = 100°C	I <sub>RM</sub>	1.0 20								mA
Typical Junction Capacitance (Note 1)	C <sub>J</sub>	750				500				pF
Thermal Resistance Junction to Ambient (Note 2) Thermal Resistance Junction to Case (Note 2)	R <sub>JA</sub> R <sub>JC</sub>	55 1.5								°C/W
Operating and Storage Temperature Range	T <sub>J</sub> , T <sub>STG</sub>	-55 to +150								°C

Note: 1. Measured at 1.0 MHz and applied reverse voltage of 4.0V D.C.  
2. Mounted on FR-4 PCB with minimum recommended pad layout per diode.

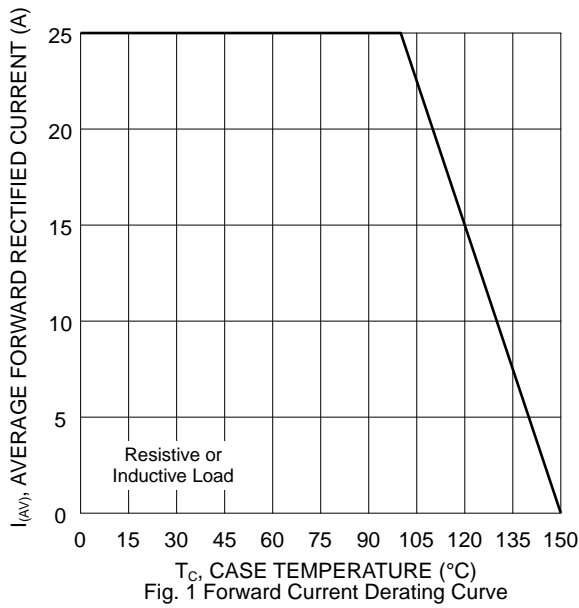

Fig. 1 Forward Current Derating Curve

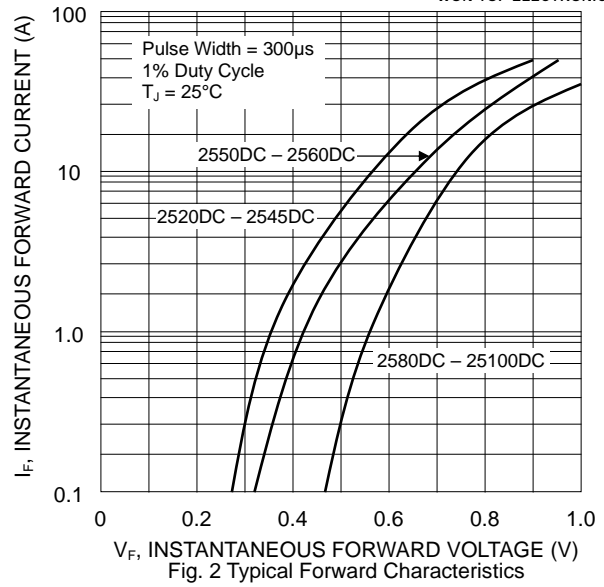

Fig. 2 Typical Forward Characteristics

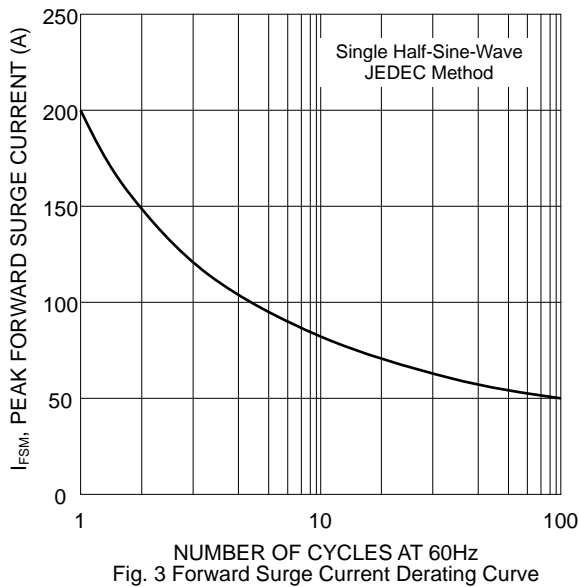

Fig. 3 Forward Surge Current Derating Curve

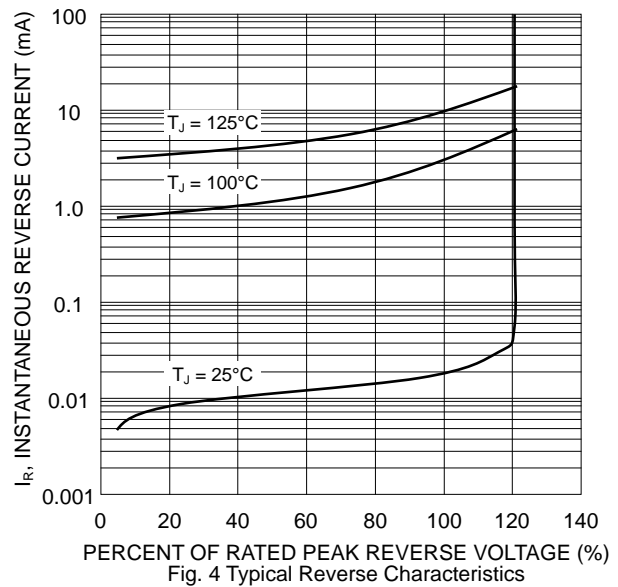

Fig. 4 Typical Reverse Characteristics

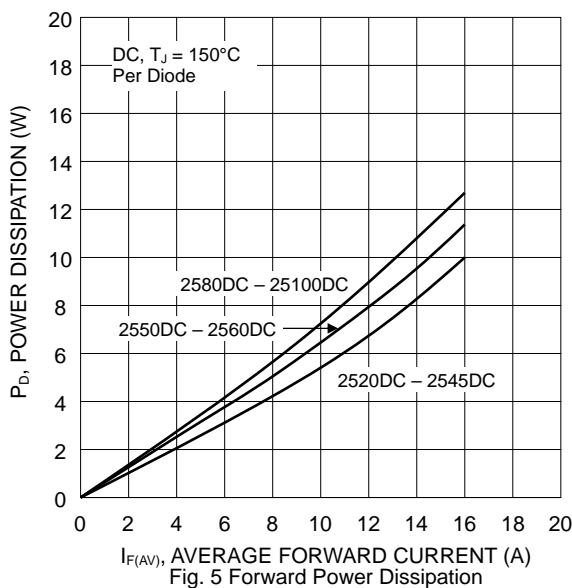

Fig. 5 Forward Power Dissipation

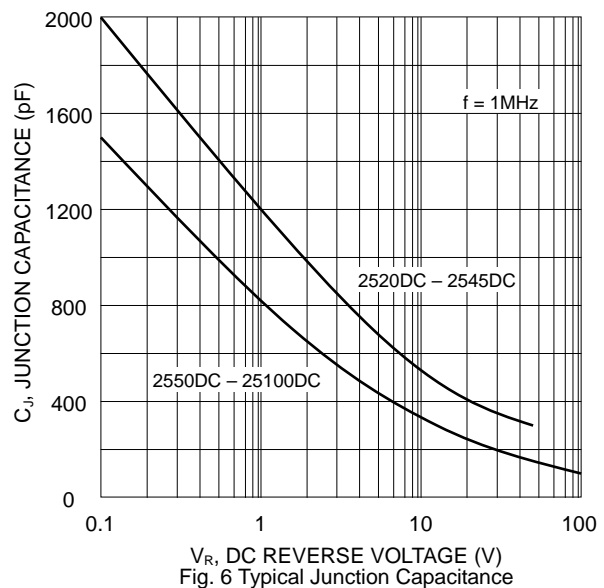
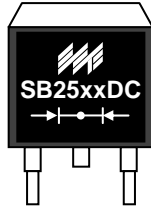

Fig. 6 Typical Junction Capacitance

## MARKING INFORMATION



SB25xxDC = Device Number  
 xx = 20, 30, 40, 45, 50, 60, 80 or 100  
 Polarity = As Marked on Body

## RECOMMENDED FOOTPRINT

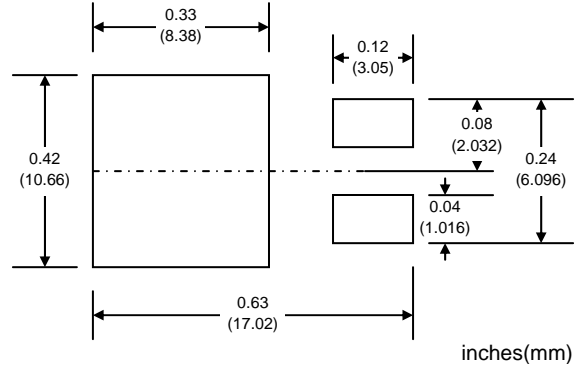

## PACKAGING INFORMATION

### TAPE & REEL

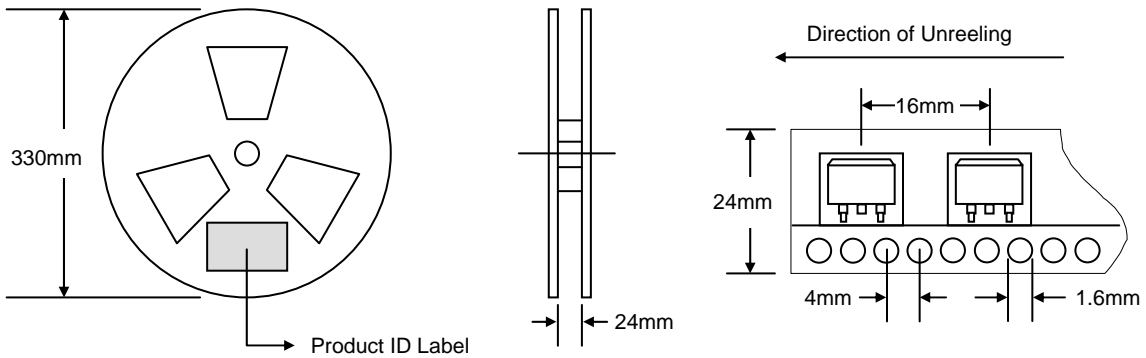

Reel Diameter (mm)	Quantity (PCS)	Inner Box Size L x W x H (mm)	Quantity (PCS)	Carton Size L x W x H (mm)	Quantity (PCS)	Approx. Gross Weight (KG)
330	800	340 x 337 x 45	800	370 x 370 x 420	6,400	15.0

**Note:** 1. Paper reel, white or gray color.  
 2. Components are packed in accordance with EIA standard 481-1 and 481-2.

## ORDERING INFORMATION

Product No.	Package Type	Shipping Quantity
SB2520DC-T3	D <sup>2</sup> PAK	800/Tape & Reel
SB2530DC-T3	D <sup>2</sup> PAK	800/Tape & Reel
SB2540DC-T3	D <sup>2</sup> PAK	800/Tape & Reel
SB2545DC-T3	D <sup>2</sup> PAK	800/Tape & Reel
SB2550DC-T3	D <sup>2</sup> PAK	800/Tape & Reel
SB2560DC-T3	D <sup>2</sup> PAK	800/Tape & Reel
SB2580DC-T3	D <sup>2</sup> PAK	800/Tape & Reel
SB25100DC-T3	D <sup>2</sup> PAK	800/Tape & Reel

1. Shipping quantity given is for minimum packing quantity only. For minimum order quantity, please consult the Sales Department.
2. **To order RoHS / Lead Free version (with Lead Free finish), add "-LF" suffix to part number above. For example, SB2520DC-T3-LF.**

WON-TOP ELECTRONICS and  are registered trademarks of Won-Top Electronics Co., Ltd (WTE). WTE has checked all information carefully and believes it to be correct and accurate. However, WTE cannot assume any responsibility for inaccuracies. Furthermore, this information does not give the purchaser of semiconductor devices any license under patent rights to manufacturer. WTE reserves the right to change any or all information herein without further notice.

**WARNING:** DO NOT USE IN LIFE SUPPORT EQUIPMENT. WTE power semiconductor products are not authorized for use as critical components in life support devices or systems without the express written approval.

**Won-Top Electronics Co., Ltd.**  
No. 44 Yu Kang North 3rd Road,  
Chine Chen Dist., Kaohsiung 806, Taiwan  
**Phone:** 886-7-822-5408 or 886-7-822-5410  
**Fax:** 886-7-822-5417  
**Email:** sales@wontop.com  
**Internet:** http://www.wontop.com

*We power your everyday.*