

Features

- Planar Die Construction
- 350mW Power Dissipation
- 2.4V – 51V Nominal Zener Voltage
- 5% Standard Vz Tolerance
- Designed for Surface Mount Application
- Plastic Material – UL Recognition Flammability Classification 94V-0

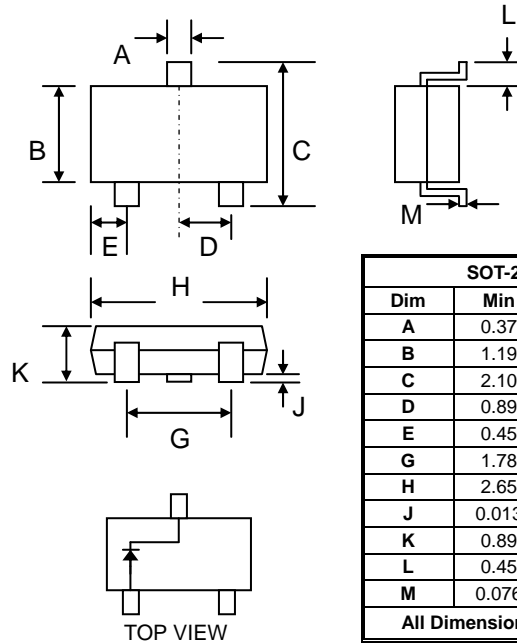

SOT-23		
Dim	Min	Max
A	0.37	0.51
B	1.19	1.40
C	2.10	2.50
D	0.89	1.05
E	0.45	0.61
G	1.78	2.05
H	2.65	3.05
J	0.013	0.15
K	0.89	1.10
L	0.45	0.61
M	0.076	0.178
All Dimensions in mm		

Mechanical Data

- Case: SOT-23, Molded Plastic
- Terminals: Plated Leads Solderable per MIL-STD-202, Method 208
- Polarity: See Diagram
- Weight: 0.008 grams (approx.)
- Mounting Position: Any
- Marking: Device Code
- **Lead Free: For RoHS / Lead Free Version, Add “-LF” Suffix to Part Number, See Page 5**

Maximum Ratings @ $T_A=25^{\circ}\text{C}$ unless otherwise specified

Characteristic	Symbol	Value	Unit
Peak Pulse Power Dissipation at $T_A = 25^{\circ}\text{C}$ (Note 1)	P_D	350	mW
Forward Voltage @ $I_F = 10\text{mA}$	V_F	0.9	V
Thermal Resistance Junction to Ambient (Note 1, 2)	R_{JA}	357	$^{\circ}\text{C/W}$
Operating and Storage Temperature Range	T_j, T_{STG}	-65 to +150	$^{\circ}\text{C}$

Note: 1. Mounted on FR-4 PCB with minimum recommended pad layout.
 2. Thermal resistance measurement obtained via infrared scan method.

MMBZ5221B – MMBZ5262B

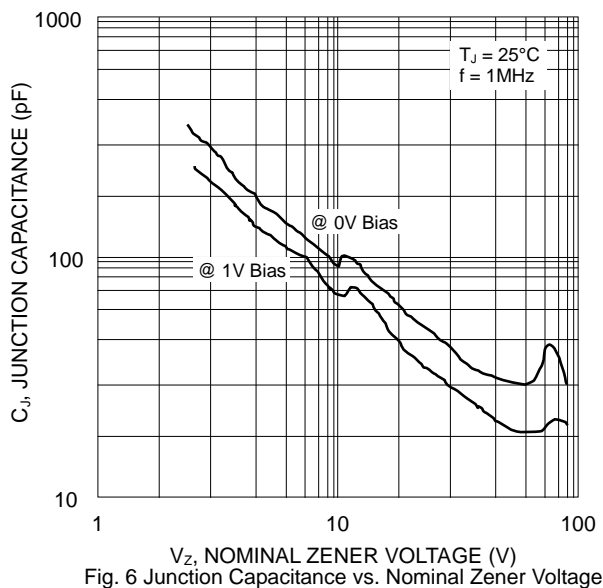
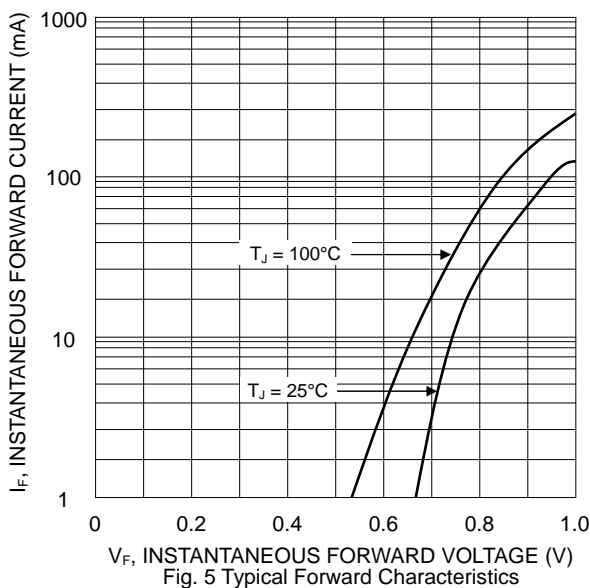
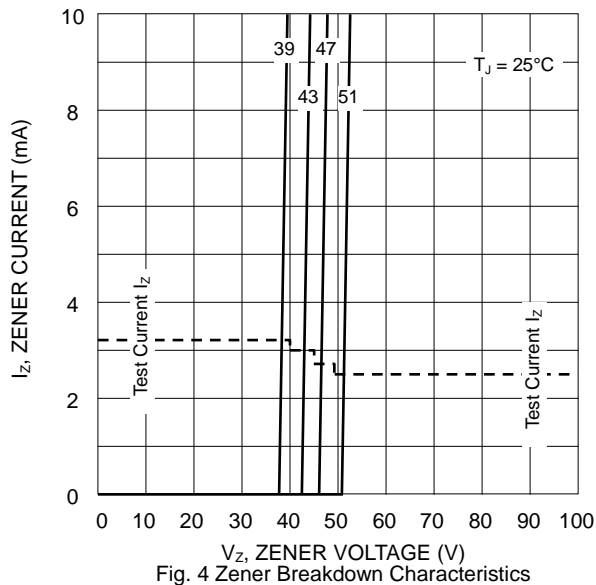
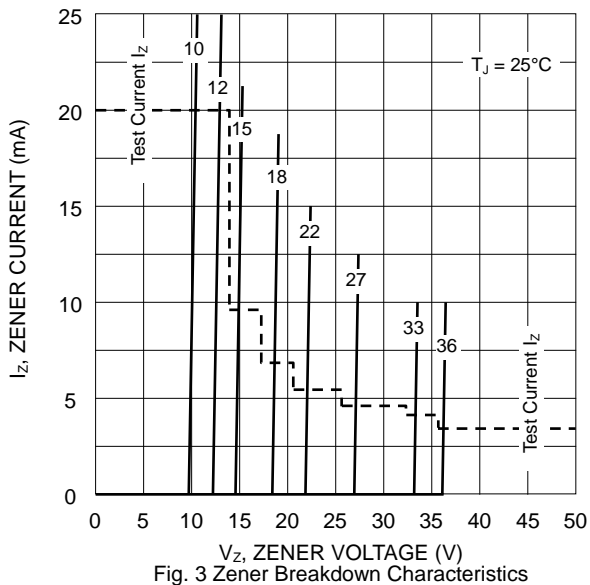
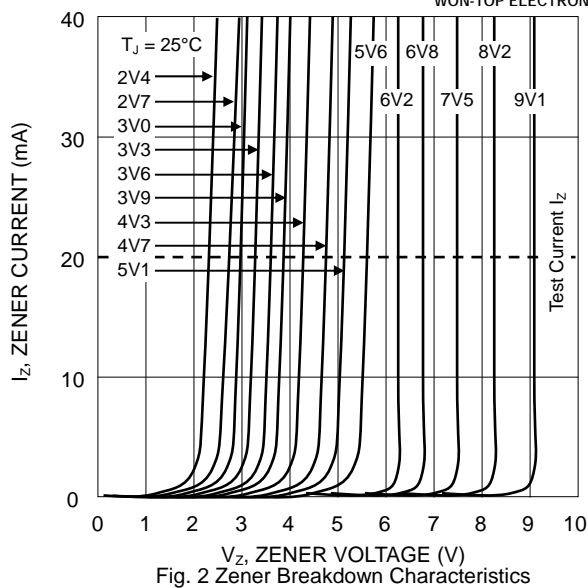
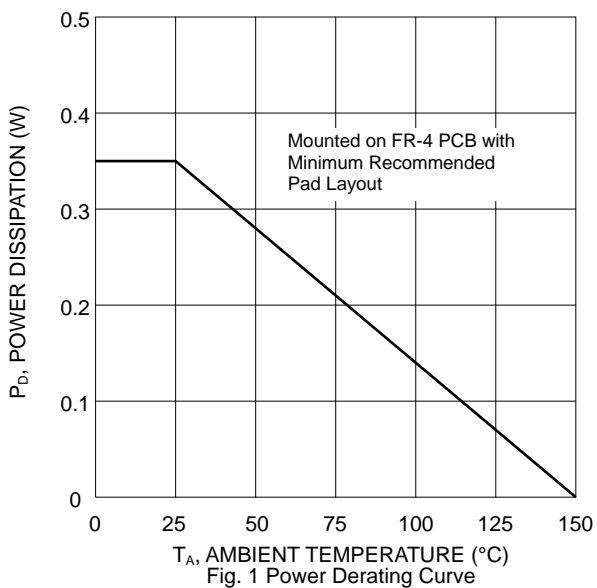

Electrical Characteristics (@T_A=25°C unless otherwise specified) Table 1

Type Number (Note 1)	Device Marking Code (Note 2)		Zener Voltage Range (Note 3)			Maximum Zener Impedance (Note 4)				Max Reverse Leakage Current		Typical Temp. Coefficient of Zener Voltage
			V _Z @ I _{ZT}			Z _{ZT} @ I _{ZT}		Z _{ZK} @ I _{ZK}		I _R	@ V _R	
	TW	CN	Nom (V)	Min (V)	Max (V)	()	(mA)	()	(mA)	(μA)	(V)	(%/°C)
MMBZ5221B	C1	KC1	2.4	2.28	2.52	30	20	1200	0.25	100	1.0	-0.075
MMBZ5222B	C2	KC2	2.5	2.38	2.63	30	20	1250	0.25	100	1.0	-0.075
MMBZ5223B	C3	KC3	2.7	2.57	2.84	30	20	1300	0.25	75	1.0	-0.075
MMBZ5225B	C5	KC5	3.0	2.85	3.15	29	20	1600	0.25	50	1.0	-0.075
MMBZ5226B	D1	KG1	3.3	3.14	3.47	28	20	1600	0.25	25	1.0	-0.070
MMBZ5227B	D2	KG2	3.6	3.42	3.78	24	20	1700	0.25	15	1.0	-0.065
MMBZ5228B	D3	KG3	3.9	3.71	4.10	23	20	1900	0.25	10	1.0	-0.060
MMBZ5229B	D4	KG4	4.3	4.09	4.52	22	20	2000	0.25	5.0	1.0	-0.055
MMBZ5230B	D5	KG5	4.7	4.47	4.94	19	20	1900	0.25	5.0	2.0	±0.030
MMBZ5231B	E1	KE1	5.1	4.85	5.36	17	20	1600	0.25	5.0	2.0	±0.030
MMBZ5232B	E2	KE2	5.6	5.32	5.88	11	20	1600	0.25	5.0	3.0	+0.038
MMBZ5233B	E3	KE3	6.0	5.70	6.30	7.0	20	1600	0.25	5.0	3.5	+0.038
MMBZ5234B	E4	KE4	6.2	5.89	6.51	7.0	20	1000	0.25	5.0	4.0	+0.045
MMBZ5235B	E5	KE5	6.8	6.46	7.14	5.0	20	750	0.25	3.0	5.0	+0.050
MMBZ5236B	F1	KF1	7.5	7.13	7.88	6.0	20	500	0.25	3.0	6.0	+0.058
MMBZ5237B	F2	KF2	8.2	7.79	8.61	8.0	20	500	0.25	3.0	6.5	+0.062
MMBZ5238B	F3	KF3	8.7	8.27	9.14	8.0	20	600	0.25	3.0	6.5	+0.065
MMBZ5239B	F4	KF4	9.1	8.65	9.56	10	20	600	0.25	3.0	7.0	+0.068
MMBZ5240B	F5	KF5	10	9.50	10.50	17	20	600	0.25	3.0	8.0	+0.075
MMBZ5241B	H1	KH1	11	10.45	11.55	22	20	600	0.25	2.0	8.4	+0.076
MMBZ5242B	H2	KH2	12	11.40	12.60	30	20	600	0.25	1.0	9.1	+0.077
MMBZ5243B	H3	KH3	13	12.35	13.65	13	9.5	600	0.25	0.5	9.9	+0.079
MMBZ5245B	H5	KH5	15	14.25	15.75	16	8.5	600	0.25	0.1	11	+0.082
MMBZ5246B	J1	KJ1	16	15.20	16.80	17	7.8	600	0.25	0.1	12	+0.083
MMBZ5248B	J3	KJ3	18	17.10	18.90	21	7.0	600	0.25	0.1	14	+0.085
MMBZ5250B	J5	KJ5	20	19.00	21.00	25	6.2	600	0.25	0.1	15	+0.086
MMBZ5251B	K1	KK1	22	20.90	23.10	29	5.6	600	0.25	0.1	17	+0.087
MMBZ5252B	K2	KK2	24	22.80	25.20	33	5.2	600	0.25	0.1	18	+0.087
MMBZ5254B	K4	KK4	27	25.65	28.35	41	4.6	600	0.25	0.1	21	+0.090
MMBZ5255B	K5	KK5	28	26.60	29.40	44	4.5	600	0.25	0.1	21	+0.091
MMBZ5256B	M1	KM1	30	28.50	31.50	49	4.2	600	0.25	0.1	23	+0.091
MMBZ5257B	M2	KM2	33	31.35	34.65	58	3.8	700	0.25	0.1	25	+0.092
MMBZ5258B	M3	KM3	36	34.20	37.80	70	3.4	700	0.25	0.1	27	+0.093
MMBZ5259B	M4	KM4	39	37.05	40.95	80	3.2	800	0.25	0.1	30	+0.094
MMBZ5260B	M5	KM5	43	40.85	45.15	93	3.0	900	0.25	0.1	33	+0.095
MMBZ5261B	N1	KN1	47	44.65	49.35	105	2.7	1000	0.25	0.1	36	+0.095
MMBZ5262B	N2	KN2	51	48.45	53.55	125	2.5	1100	0.25	0.1	39	+0.096

- Note: 1. Type numbers listed have standard tolerance on the nominal zener voltage of ±5%.
 2. TW: Marking code for Taiwan plant. CN: Marking code for China plant.
 3. Measured with pulse test current I_Z at ambient temperature 25°C.
 4. f = 1KHz

MARKING INFORMATION

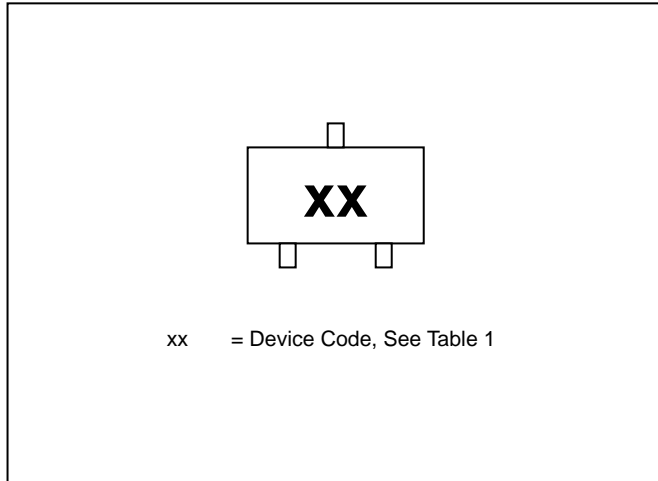

RECOMMENDED FOOTPRINT

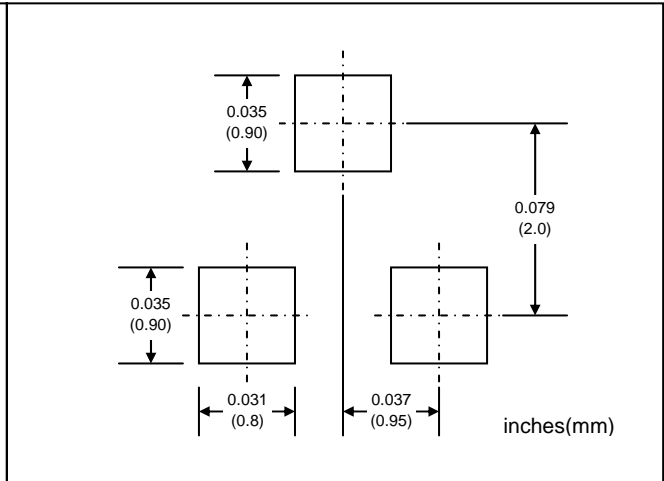

PACKAGING INFORMATION

TAPE & REEL

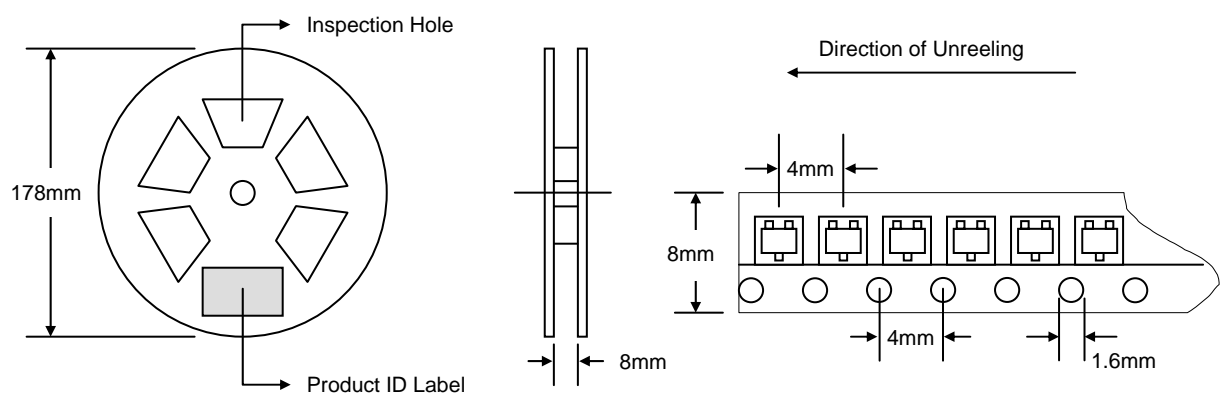

Reel Diameter (mm)	Quantity (PCS)	Inner Box Size L x W x H (mm)	Quantity (PCS)	Carton Size L x W x H (mm)	Quantity (PCS)	Approx. Gross Weight (KG)
178	3,000	187 x 187 x 65	15,000	390 x 240 x 420	150,000	10.0

Note: 1. Anti-static plastic reel, white, water clear or blue color. Inspection hole might be varied in different alignment.
2. Components are packed in accordance with EIA standard 481-1 and 481-2.

ORDERING INFORMATION

Product No.	Package Type	Shipping Quantity
MMBZ52xxB-T1	SOT-23	3000/Tape & Reel

1. Shipping quantity given is for minimum packing quantity only. For minimum order quantity, please consult the Sales Department.
2. **To order RoHS / Lead Free version (with Lead Free finish), add “-LF” suffix to part number above. For example, MMBZ5221B-T1-LF.**

WON-TOP ELECTRONICS and  are registered trademarks of Won-Top Electronics Co., Ltd (WTE). WTE has checked all information carefully and believes it to be correct and accurate. However, WTE cannot assume any responsibility for inaccuracies. Furthermore, this information does not give the purchaser of semiconductor devices any license under patent rights to manufacturer. WTE reserves the right to change any or all information herein without further notice.

WARNING: DO NOT USE IN LIFE SUPPORT EQUIPMENT. WTE power semiconductor products are not authorized for use as critical components in life support devices or systems without the express written approval.

Won-Top Electronics Co., Ltd.
No. 44 Yu Kang North 3rd Road,
Chine Chen Dist., Kaohsiung 806, Taiwan
Phone: 886-7-822-5408 or 886-7-822-5410
Fax: 886-7-822-5417
Email: sales@wontop.com
Internet: <http://www.wontop.com>

We power your everyday.