

### Features

- Planar Die Construction
- 500mW Power Dissipation
- 2.4V – 51V Nominal Zener Voltage
- 2% Standard Vz Tolerance
- Designed for Surface Mount Application
- Plastic Material – UL Recognition Flammability Classification 94V-0

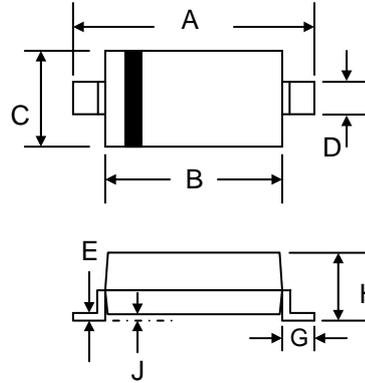

SOD-123		
Dim	Min	Max
A	3.6	3.9
B	2.5	2.8
C	1.4	1.8
D	0.5	0.7
E	—	0.2
G	0.4	—
H	0.95	1.35
J	—	0.12
All Dimensions in mm		

### Mechanical Data

- Case: SOD-123, Molded Plastic
- Terminals: Plated Leads Solderable per MIL-STD-202, Method 208
- Polarity: Cathode Band
- Weight: 0.01 grams (approx.)
- Marking: Device Code
- **Lead Free: For RoHS / Lead Free Version, Add “-LF” Suffix to Part Number, See Page 5**

### Maximum Ratings @T<sub>A</sub>=25°C unless otherwise specified

Characteristic	Symbol	Value	Unit
Power Dissipation at T <sub>L</sub> = 75°C (Note 1)	P <sub>D</sub>	500	mW
Power Dissipation at T <sub>A</sub> = 25°C (Note 2)	P <sub>D</sub>	410	mW
Forward Voltage @ I <sub>F</sub> = 10mA	V <sub>F</sub>	0.9	V
Thermal Resistance, Junction to Ambient (Note 2, 3)	R <sub>JA</sub>	340	°C/W
Thermal Resistance, Junction to Lead (Note 2, 3)	R <sub>JL</sub>	150	°C/W
Operating and Storage Temperature Range	T <sub>J</sub> , T <sub>STG</sub>	-65 to +150	°C

- Note: 1. Mounted on ceramic substrate with 25mm<sup>2</sup> copper pads.  
 2. Mounted on ceramic substrate with 40mm<sup>2</sup> copper pads.  
 3. Thermal resistance measurement obtained via infrared scan method.

# BZT52B2V4 – BZT52B51

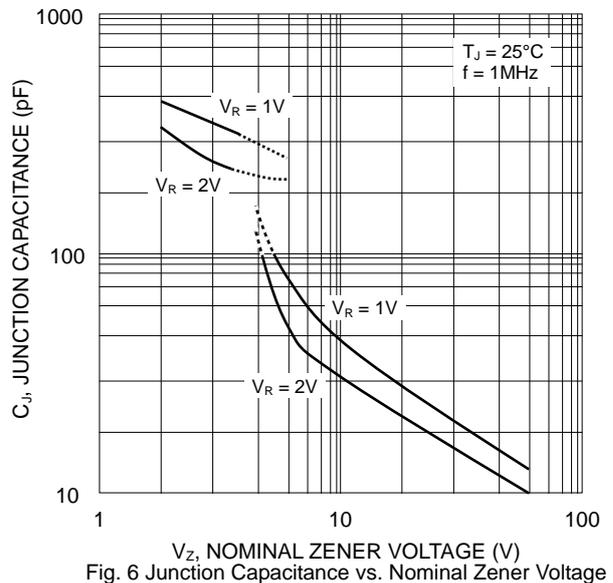
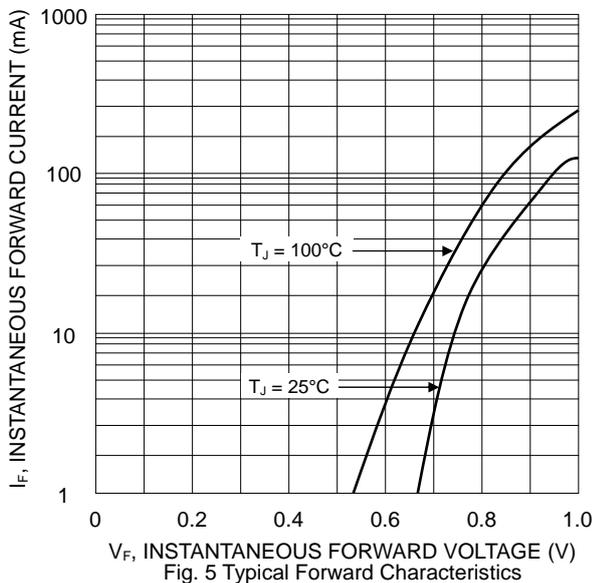
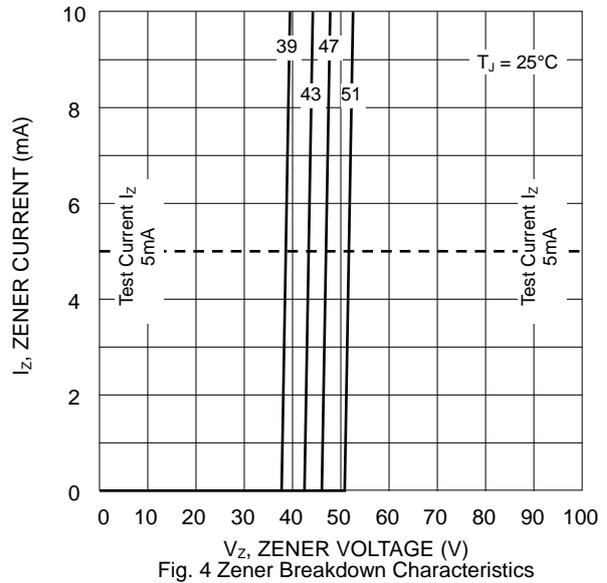
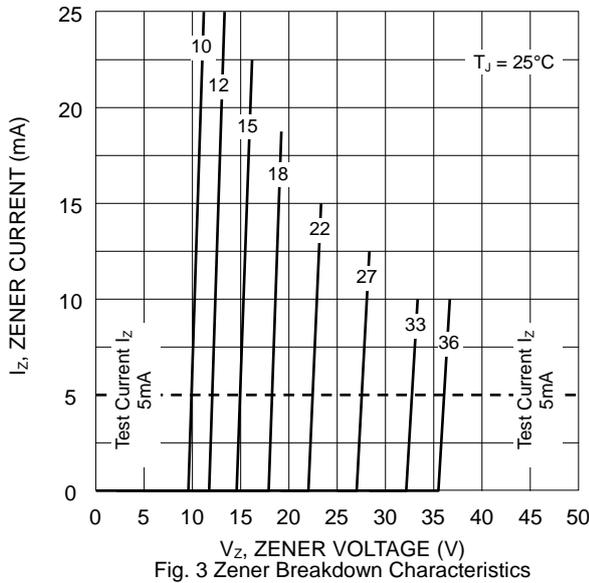
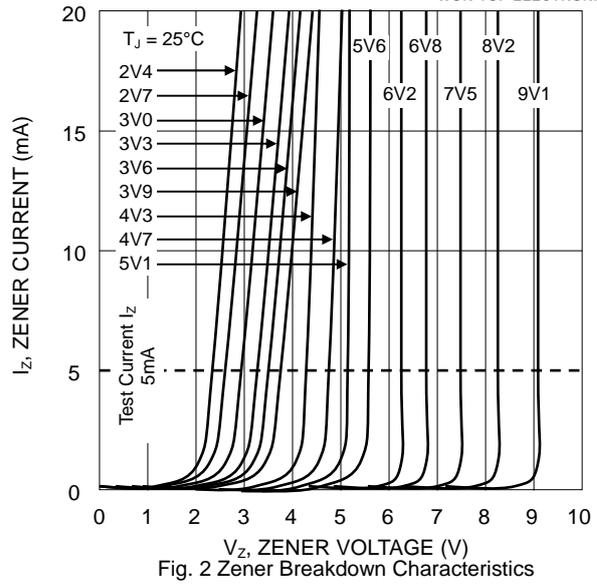
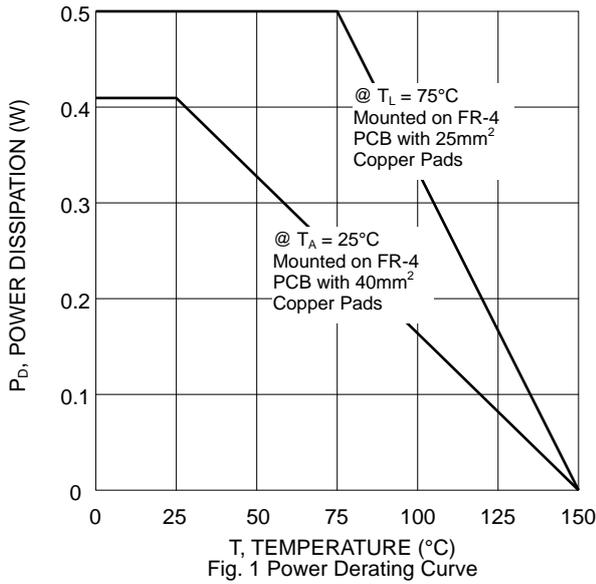

**Electrical Characteristics (@T<sub>A</sub>=25°C unless otherwise specified) Table 1**

Type Number (Note 1)	Device Marking Code (Note 2)		Zener Voltage Range (Note 3)			Maximum Zener Impedance (Note 4)				Max Reverse Leakage Current		Temp. Coefficient of Zener Voltage @ I <sub>ZT</sub> (mV/°C)	
			V <sub>Z</sub> @ I <sub>ZT</sub>			Z <sub>ZT</sub> @ I <sub>ZT</sub>		Z <sub>ZK</sub> @ I <sub>ZK</sub>		I <sub>R</sub>	@ V <sub>R</sub>		
	TW	CN	Nom (V)	Min (V)	Max (V)	( )	(mA)	( )	(mA)	(μA)	(V)	Min	Max
BZT52B2V4	W1	W1•	2.4	2.35	2.45	85	5.0	600	1.0	100	1.0	-9	-4
BZT52B2V7	W2	W2•	2.7	2.65	2.75	83	5.0	500	1.0	75	1.0	-9	-4
BZT52B3V0	W3	W3•	3.0	2.94	3.06	95	5.0	500	1.0	50	1.0	-9	-3
BZT52B3V3	W4	W4•	3.3	3.23	3.37	95	5.0	500	1.0	25	1.0	-8	-3
BZT52B3V6	W5	W5•	3.6	3.53	3.67	95	5.0	500	1.0	15	1.0	-8	-3
BZT52B3V9	W6	W6•	3.9	3.82	3.98	95	5.0	500	1.0	10	1.0	-7	-3
BZT52B4V3	W7	W7•	4.3	4.21	4.39	95	5.0	500	1.0	5.0	1.0	-6	-1
BZT52B4V7	W8	W8•	4.7	4.61	4.79	78	5.0	500	1.0	5.0	1.0	-5	+2
BZT52B5V1	W9	W9•	5.1	5.00	5.20	60	5.0	480	1.0	0.1	0.8	-3	+4
BZT52B5V6	WA	WA•	5.6	5.49	5.71	40	5.0	400	1.0	0.1	1.0	-2	+6
BZT52B6V2	WB	WB•	6.2	6.08	6.32	10	5.0	200	1.0	0.1	2.0	-1	+7
BZT52B6V8	WC	WC•	6.8	6.66	6.94	8	5.0	150	1.0	0.1	3.0	+2	+7
BZT52B7V5	WD	WD•	7.5	7.35	7.65	7	5.0	50	1.0	0.1	5.0	+3	+7
BZT52B8V2	WE	WE•	8.2	8.04	8.36	7	5.0	50	1.0	0.1	6.0	+4	+7
BZT52B9V1	WF	WF•	9.1	8.92	9.28	10	5.0	50	1.0	0.1	7.0	+5	+8
BZT52B10	WG	WG•	10	9.80	10.20	15	5.0	70	1.0	0.1	7.5	+5	+8
BZT52B11	WH	WH•	11	10.80	11.20	20	5.0	70	1.0	0.1	8.5	+5	+9
BZT52B12	WI	WI•	12	11.80	12.20	20	5.0	90	1.0	0.1	9.0	+6	+9
BZT52B13	WK	WJ•	13	12.70	13.30	25	5.0	110	1.0	0.1	10	+7	+9
BZT52B15	WL	WK•	15	14.70	15.30	30	5.0	110	1.0	0.1	11	+7	+9
BZT52B16	WM	WL•	16	15.70	16.30	40	5.0	170	1.0	0.1	12	+8	+9.5
BZT52B18	WN	WM•	18	17.60	18.40	50	5.0	170	1.0	0.1	14	+8	+9.5
BZT52B20	WO	WN•	20	19.60	20.40	50	5.0	220	1.0	0.1	15	+8	+10
BZT52B22	WP	WO•	22	21.60	22.40	55	5.0	220	1.0	0.1	17	+8	+10
BZT52B24	WR	WP•	24	23.50	24.50	80	5.0	220	1.0	0.1	18	+8	+10
BZT52B27	WS	WQ•	27	26.50	27.50	80	5.0	250	1.0	0.1	20	+8	+10
BZT52B30	WT	WR•	30	29.40	30.60	80	5.0	250	1.0	0.1	22.5	+8	+10
BZT52B33	WU	WS•	33	32.30	33.70	80	5.0	250	1.0	0.1	25	+8	+10
BZT52B36	WW	WT•	36	35.30	36.70	90	5.0	250	1.0	0.1	27	+8	+10
BZT52B39	WX	WU•	39	38.20	39.80	90	5.0	300	1.0	0.1	29	+10	+12
BZT52B43	WY	WV•	43	42.10	43.90	100	5.0	700	1.0	0.1	32	+10	+12
BZT52B47	WZ	WW•	47	46.10	47.90	100	5.0	750	1.0	0.1	35	+10	+12
BZT52B51	XA	X1•	51	50.00	52.00	100	5.0	750	1.0	0.1	38	+10	+12

- Note: 1. Type numbers listed have standard tolerance on the nominal zener voltage of ±2%.  
 2. TW: Marking code for Taiwan plant. CN: Marking code for China plant.  
 3. Measured with pulses t<sub>p</sub> = 5ms.  
 4. f = 1KHz

## MARKING INFORMATION

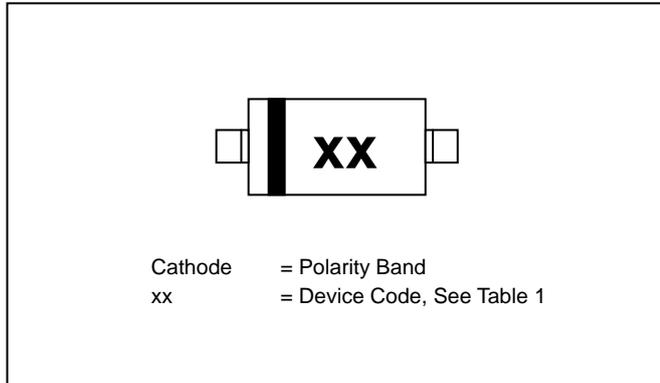

## RECOMMENDED FOOTPRINT

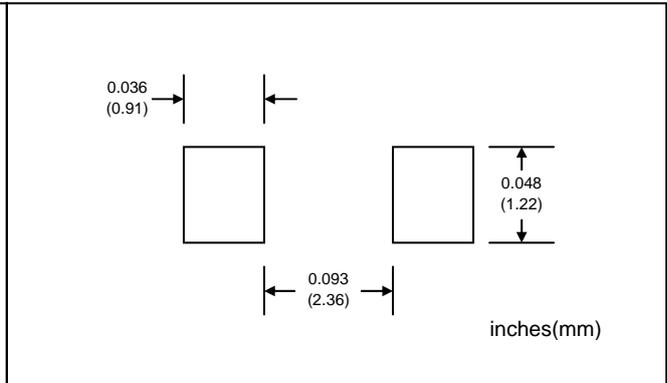

## PACKAGING INFORMATION

### TAPE & REEL

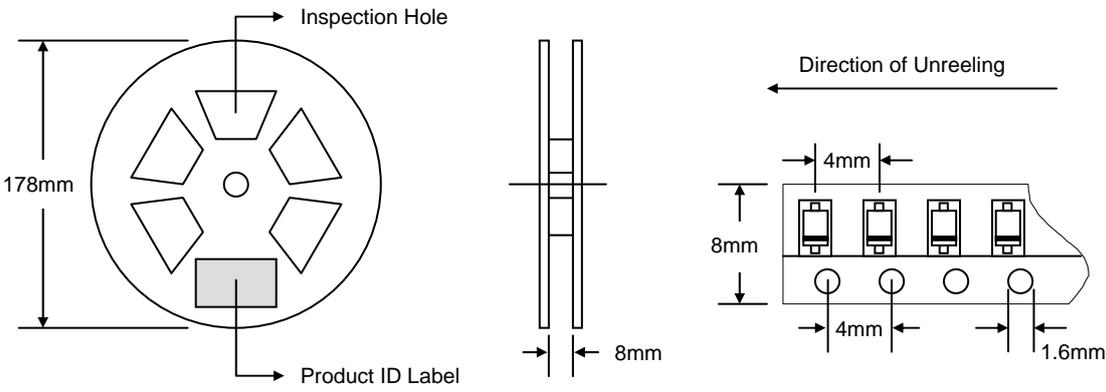

Reel Diameter (mm)	Quantity (PCS)	Inner Box Size L x W x H (mm)	Quantity (PCS)	Carton Size L x W x H (mm)	Quantity (PCS)	Approx. Gross Weight (KG)
178	3,000	187 x 187 x 65	15,000	390 x 240 x 420	150,000	10.0

**Note:** 1. Anti-static plastic reel, white, water clear or blue color. Inspection hole might be varied in different alignment.  
2. Components are packed in accordance with EIA standard 481-1 and 481-2.

## ORDERING INFORMATION

Product No.	Package Type	Shipping Quantity
BZT52Bxx-T1	SOD-123	3000/Tape & Reel

1. Shipping quantity given is for minimum packing quantity only. For minimum order quantity, please consult the Sales Department.
2. **To order RoHS / Lead Free version (with Lead Free finish), add "-LF" suffix to part number above. For example, BZT52B2V4-T1-LF.**

WON-TOP ELECTRONICS and  are registered trademarks of Won-Top Electronics Co., Ltd (WTE). WTE has checked all information carefully and believes it to be correct and accurate. However, WTE cannot assume any responsibility for inaccuracies. Furthermore, this information does not give the purchaser of semiconductor devices any license under patent rights to manufacturer. WTE reserves the right to change any or all information herein without further notice.

**WARNING:** DO NOT USE IN LIFE SUPPORT EQUIPMENT. WTE power semiconductor products are not authorized for use as critical components in life support devices or systems without the express written approval.

**Won-Top Electronics Co., Ltd.**  
No. 44 Yu Kang North 3rd Road,  
Chine Chen Dist., Kaohsiung 806, Taiwan  
**Phone:** 886-7-822-5408 or 886-7-822-5410  
**Fax:** 886-7-822-5417  
**Email:** sales@wontop.com  
**Internet:** <http://www.wontop.com>

*We power your everyday.*