

### Features

- Glass Passivated Die Construction
- 2.0W Power Dissipation
- 2.7V – 330V Nominal Zener Voltage
- 5% Standard Vz Tolerance
- Low Inductance
- For Use in Voltage Regulator or Reference
- Plastic Case Material has UL Flammability Classification Rating 94V-0

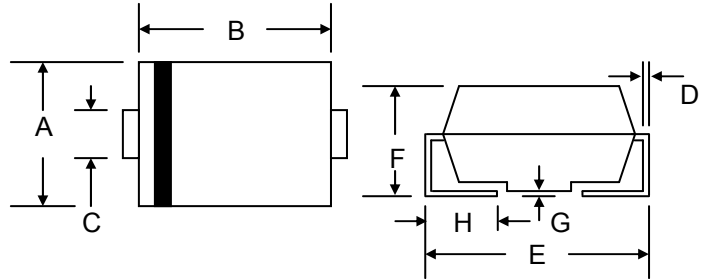

### Mechanical Data

- Case: SMA/DO-214AC, Molded Plastic
- Terminals: Solder Plated, Solderable per MIL-STD-750, Method 2026
- Polarity: Cathode Band
- Marking: Device Code
- Weight: 0.064 grams (approx.)
- **Lead Free: For RoHS / Lead Free Version, Add "-LF" Suffix to Part Number, See Page 6**

SMA/DO-214AC		
Dim	Min	Max
A	2.29	2.92
B	4.00	4.60
C	1.27	1.90
D	0.152	0.305
E	4.80	5.30
F	2.00	2.44
G	0.051	0.203
H	0.76	1.52
All Dimensions in mm		

### Maximum Ratings @ $T_A=25^{\circ}\text{C}$ unless otherwise specified

Characteristic	Symbol	Value	Unit
Power Dissipation at $T_L = 60^{\circ}\text{C}$ (Note 1)	$P_D$	2.0	W
Forward Voltage @ $I_F = 200\text{mA}$	$V_F$	1.2	V
Thermal Resistance, Junction to Ambient (Note 2)	$R_{JA}$	250	$^{\circ}\text{C/W}$
Thermal Resistance, Junction to Lead (Note 1)	$R_{JL}$	50	$^{\circ}\text{C/W}$
Operating and Storage Temperature Range	$T_J, T_{STG}$	-65 to +150	$^{\circ}\text{C}$

Note: 1. Mounted on FR-4 PCB with 25.4 x 25.4mm copper pads.  
 2. Mounted on ceramic substrate with minimum recommended pad layout.

# 1SMA2EZ2.7D5 – 1SMA2EZ330D

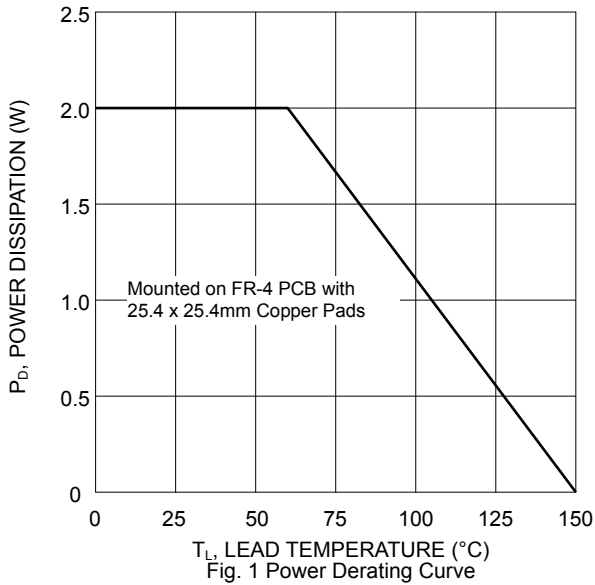

Fig. 1 Power Derating Curve

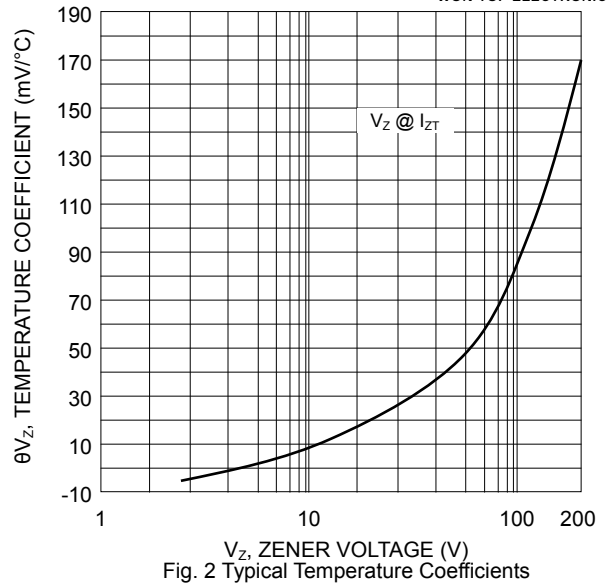

Fig. 2 Typical Temperature Coefficients

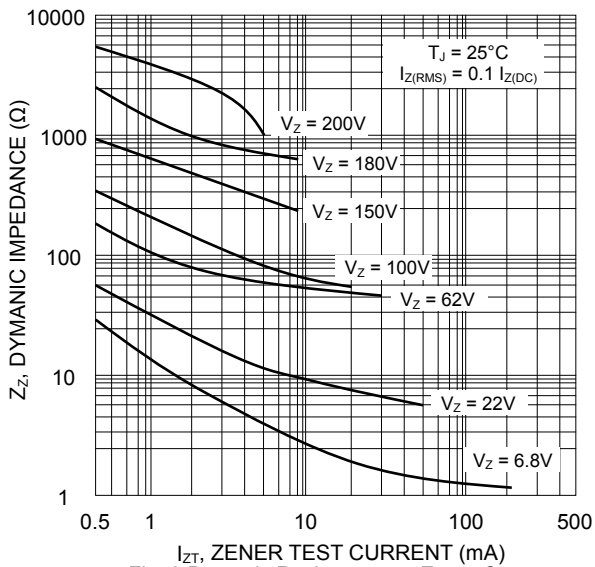

Fig. 3 Dynamic Resistance vs. Zener Current

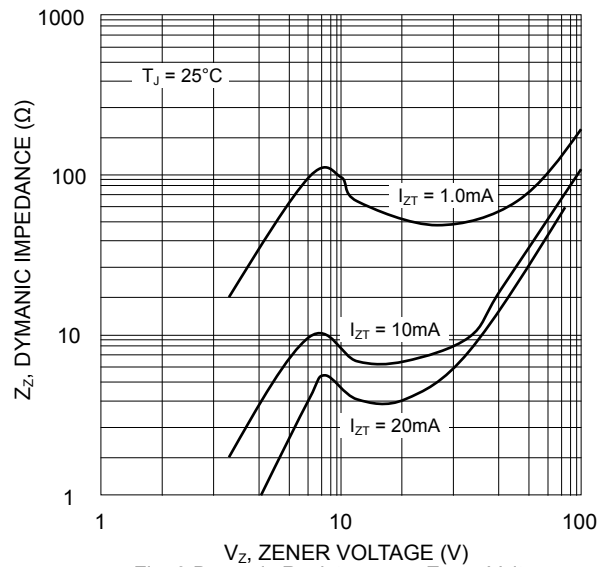

Fig. 3 Dynamic Resistance vs. Zener Voltage

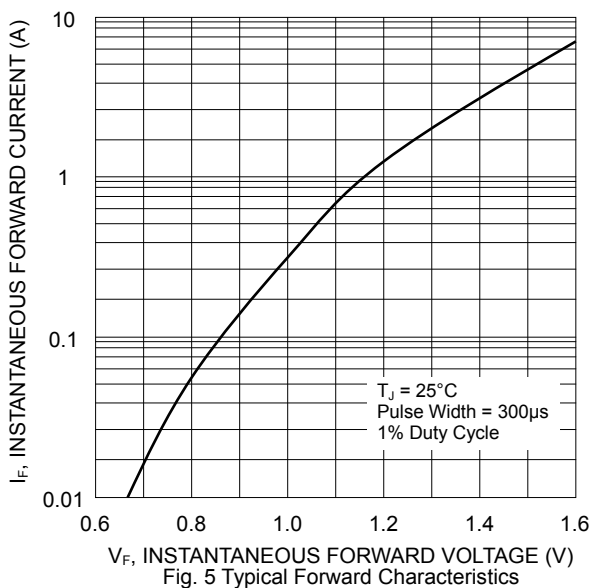

Fig. 5 Typical Forward Characteristics

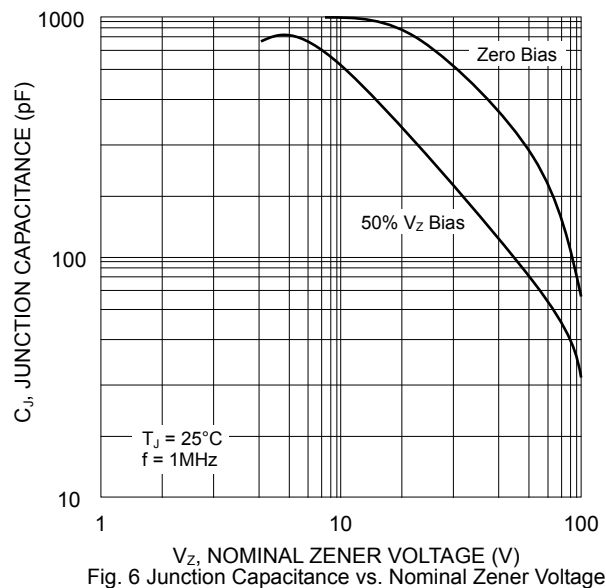

Fig. 6 Junction Capacitance vs. Nominal Zener Voltage

**Electrical Characteristics (@T<sub>A</sub>=25°C unless otherwise specified) Table 1**

Type Number (Note 1)	Device Marking Code	Nominal Zener Voltage (Note 2)	Test Current	Maximum Zener Impedance (Note 3)			Maximum Leakage Current		Max DC Zener Current
		V <sub>Z</sub> @ I <sub>ZT</sub>	I <sub>ZT</sub>	Z <sub>ZT</sub> @ I <sub>ZT</sub>	Z <sub>ZK</sub> @ I <sub>ZK</sub>	I <sub>ZK</sub>	I <sub>R</sub> @ V <sub>R</sub>		I <sub>ZM</sub>
		(V)	(mA)	( )	( )	(mA)	(μA)	(V)	(mA)
1SMA2EZ2.7D5	2H0	2.7	180.0	10.0	400	1.00	100	1.0	670
1SMA2EZ3.0D5	2H1	3.0	160.0	8.0	400	1.00	100	1.0	603
1SMA2EZ3.3D5	2H2	3.3	145.0	8.0	400	1.00	80	1.0	548
1SMA2EZ3.6D5	2H3	3.6	139.0	5.0	400	1.00	80	1.0	504
1SMA2EZ3.9D5	2H4	3.9	128.0	5.0	400	1.00	30	1.0	468
1SMA2EZ4.3D5	2H5	4.3	116.0	4.5	400	1.00	20	1.0	434
1SMA2EZ4.7D5	2H6	4.7	106.0	4.5	550	1.00	5.0	1.0	386
1SMA2EZ5.1D5	2H7	5.1	98.0	3.5	600	1.00	5.0	1.0	356
1SMA2EZ5.6D5	2H8	5.6	89.5	2.5	500	1.00	5.0	2.0	324
1SMA2EZ6.2D5	2A0	6.2	80.5	1.5	700	1.00	5.0	3.0	292
1SMA2EZ6.8D5	2A1	6.8	73.5	2.0	700	1.00	5.0	4.0	266
1SMA2EZ7.5D5	2A2	7.5	66.5	2.0	700	0.50	5.0	5.0	242
1SMA2EZ8.2D5	2A3	8.2	61.0	2.3	700	0.50	5.0	6.0	220
1SMA2EZ9.1D5	2A4	9.1	55.0	2.5	700	0.50	3.0	7.0	200
1SMA2EZ10D5	2A5	10	50.0	3.5	700	0.25	3.0	7.6	182
1SMA2EZ11D5	2A6	11	45.5	4.0	700	0.25	1.0	8.4	166
1SMA2EZ12D5	2A7	12	41.5	4.5	700	0.25	1.0	9.1	152
1SMA2EZ13D5	2A8	13	38.5	5.0	700	0.25	0.5	9.9	138
1SMA2EZ14D5	2A9	14	35.7	5.5	700	0.25	0.5	10.6	130
1SMA2EZ15D5	2B0	15	33.4	7.0	700	0.25	0.5	11.4	122
1SMA2EZ16D5	2B1	16	31.2	8.0	700	0.25	0.5	12.2	114
1SMA2EZ17D5	2B2	17	29.4	9.0	750	0.25	0.5	13.0	107
1SMA2EZ18D5	2B3	18	27.8	10.0	750	0.25	0.5	13.7	100
1SMA2EZ19D5	2B4	19	26.3	11.0	750	0.25	0.5	14.4	95
1SMA2EZ20D5	2B5	20	25.0	11.0	750	0.25	0.5	15.2	90
1SMA2EZ22D5	2B6	22	22.8	12.0	750	0.25	0.5	16.7	82
1SMA2EZ24D5	2B7	24	20.8	13.0	750	0.25	0.5	18.2	76
1SMA2EZ27D5	2B8	27	18.5	18.0	750	0.25	0.5	20.6	68
1SMA2EZ30D5	2B9	30	16.6	20.0	1000	0.25	0.5	22.5	60
1SMA2EZ33D5	2C0	33	15.1	23.0	1000	0.25	0.5	25.1	55
1SMA2EZ36D5	2C1	36	13.9	25.0	1000	0.25	0.5	27.4	50
1SMA2EZ39D5	2C2	39	12.8	30.0	1000	0.25	0.5	29.7	47
1SMA2EZ43D5	2C3	43	11.6	35.0	1500	0.25	0.5	32.7	43
1SMA2EZ47D5	2C4	47	10.6	40.0	1500	0.25	0.5	35.8	39
1SMA2EZ51D5	2C5	51	9.8	48.0	1500	0.25	0.5	38.8	36
1SMA2EZ56D5	2C6	56	9.0	55.0	2000	0.25	0.5	42.6	32
1SMA2EZ62D5	2C7	62	8.1	60.0	2000	0.25	0.5	47.1	29
1SMA2EZ68D5	2C8	68	7.4	75.0	2000	0.25	0.5	51.7	27
1SMA2EZ75D5	2C9	75	6.7	90.0	2000	0.25	0.5	56.0	24
1SMA2EZ82D5	2F0	82	6.1	100.0	3000	0.25	0.5	62.2	22

- Note: 1. Type numbers listed have standard tolerance on the nominal zener voltage of ±5%.  
 2. Measured under thermal equilibrium and DC (I<sub>ZT</sub>) test conditions.  
 3. The Zener impedance is derived from the 60Hz AC voltage which results when an AC current having an RMS value equal to 10% of the Zener current (I<sub>ZT</sub> or I<sub>ZK</sub>) is superimposed on I<sub>ZT</sub> or I<sub>ZK</sub>. Zener impedance is measured at two points to insure a sharp knee on the breakdown curve and to eliminate unstable units.

# 1SMA2EZ2.7D5 – 1SMA2EZ330D5



**Electrical Characteristics (@T<sub>A</sub>=25°C unless otherwise specified) Table 1 (Cont'd)**

Type Number (Note 1)	Device Marking Code	Nominal Zener Voltage (Note 2)	Test Current	Maximum Zener Impedance (Note 3)			Maximum Leakage Current		Max DC Zener Current
		V <sub>Z</sub> @ I <sub>ZT</sub>	I <sub>ZT</sub>	Z <sub>ZT</sub> @ I <sub>ZT</sub>	Z <sub>ZK</sub> @ I <sub>ZK</sub>	I <sub>ZK</sub>	I <sub>R</sub> @ V <sub>R</sub>		I <sub>ZM</sub>
		(V)	(mA)	( )	( )	(mA)	(μA)	(V)	(mA)
1SMA2EZ91D5	2F1	91	5.5	125.0	3000	0.25	0.5	69.2	20
1SMA2EZ100D5	2F2	100	5.0	175.0	3000	0.25	0.5	76.0	18
1SMA2EZ110D5	2F3	110	4.5	250.0	4000	0.25	0.5	83.6	17
1SMA2EZ120D5	2F4	120	4.2	325.0	4500	0.25	0.5	91.2	15
1SMA2EZ130D5	2F5	130	3.8	400.0	5000	0.25	0.5	98.8	14
1SMA2EZ140D5	2F6	140	3.6	500.0	5500	0.25	0.5	106.4	13
1SMA2EZ150D5	2F7	150	3.3	575.0	6000	0.25	0.5	114.0	12
1SMA2EZ160D5	2F8	160	3.1	650.0	6500	0.25	0.5	121.6	11
1SMA2EZ170D5	2F9	170	2.9	675.0	7000	0.25	0.5	130.4	11
1SMA2EZ180D5	2G1	180	2.8	725.0	7000	0.25	0.5	136.8	10
1SMA2EZ190D5	2G2	190	2.6	825.0	8000	0.25	0.5	144.8	10
1SMA2EZ200D5	2G3	200	2.5	900.0	8000	0.25	0.5	152.0	9.0
1SMA2EZ220D5	2G4	220	2.0	2000.0	8500	0.25	0.5	167.0	8.0
1SMA2EZ270D5	2G5	270	1.6	2200.0	8500	0.25	0.5	205.0	6.7
1SMA2EZ300D5	2G6	300	1.5	2200.0	9000	0.25	0.5	228.0	5.9
1SMA2EZ330D5	2G7	330	1.4	2300.0	9000	0.25	0.5	250.0	5.4

- Note:
1. Type numbers listed have standard tolerance on the nominal zener voltage of ±5%.
  2. Measured under thermal equilibrium and DC (I<sub>ZT</sub>) test conditions.
  3. The Zener impedance is derived from the 60Hz AC voltage which results when an AC current having an RMS value equal to 10% of the Zener current (I<sub>ZT</sub> or I<sub>ZK</sub>) is superimposed on I<sub>ZT</sub> or I<sub>ZK</sub>. Zener impedance is measured at two points to insure a sharp knee on the breakdown curve and to eliminate unstable units.

## MARKING INFORMATION

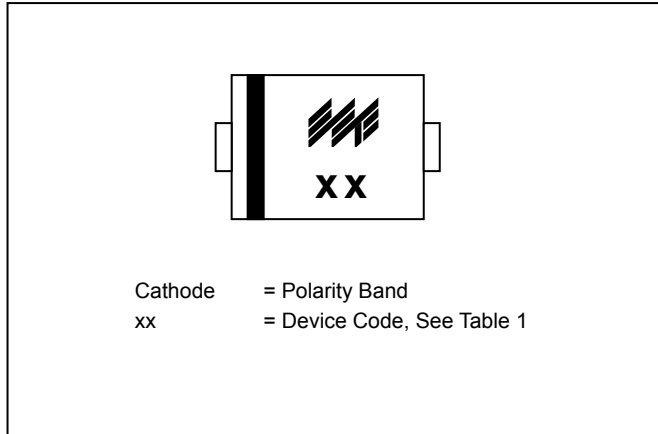

## RECOMMENDED FOOTPRINT

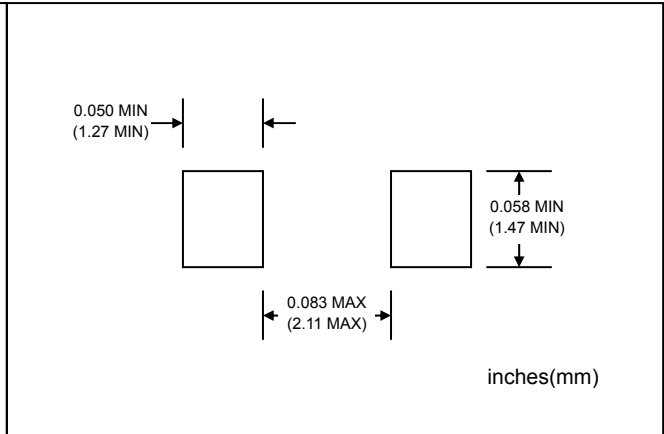

## PACKAGING INFORMATION

### TAPE & REEL

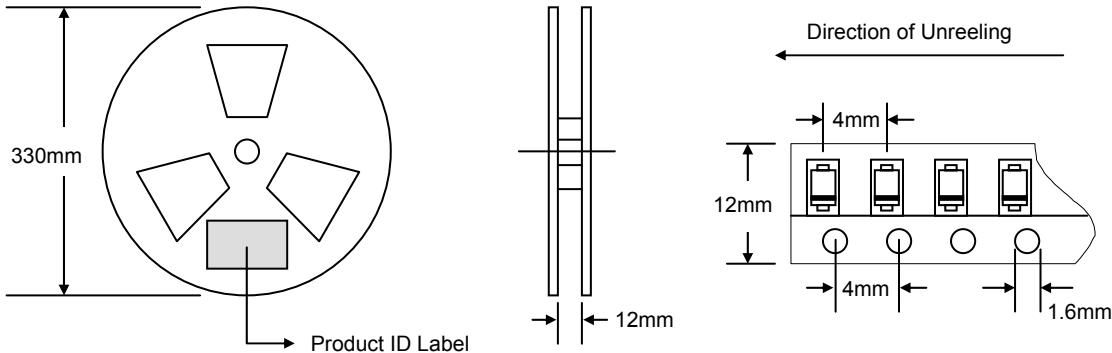

Reel Diameter (mm)	Quantity (PCS)	Inner Box Size L x W x H (mm)	Quantity (PCS)	Carton Size L x W x H (mm)	Quantity (PCS)	Approx. Gross Weight (KG)
330	5,000	340 x 337 x 45	10,000	370 x 370 x 420	80,000	14.0

**Note:** 1. Paper reel, white or gray color.  
2. Components are packed in accordance with EIA standard 481-1 and 481-2.

## ORDERING INFORMATION

Product No.	Package Type	Shipping Quantity
1SMA2EZxxD5-T3	SMA	5000/Tape & Reel

1. Shipping quantity given is for minimum packing quantity only. For minimum order quantity, please consult the Sales Department.
2. **To order RoHS / Lead Free version (with Lead Free finish), add "-LF" suffix to part number above. For example, 1SMA2EZ2.7D5-T3-LF.**

WON-TOP ELECTRONICS and  are registered trademarks of Won-Top Electronics Co., Ltd (WTE). WTE has checked all information carefully and believes it to be correct and accurate. However, WTE cannot assume any responsibility for inaccuracies. Furthermore, this information does not give the purchaser of semiconductor devices any license under patent rights to manufacturer. WTE reserves the right to change any or all information herein without further notice.

**WARNING:** DO NOT USE IN LIFE SUPPORT EQUIPMENT. WTE power semiconductor products are not authorized for use as critical components in life support devices or systems without the express written approval.

**Won-Top Electronics Co., Ltd.**  
No. 44 Yu Kang North 3rd Road,  
Chine Chen Dist., Kaohsiung 806, Taiwan  
**Phone:** 886-7-822-5408 or 886-7-822-5410  
**Fax:** 886-7-822-5417  
**Email:** sales@wontop.com  
**Internet:** http://www.wontop.com

*We power your everyday.*