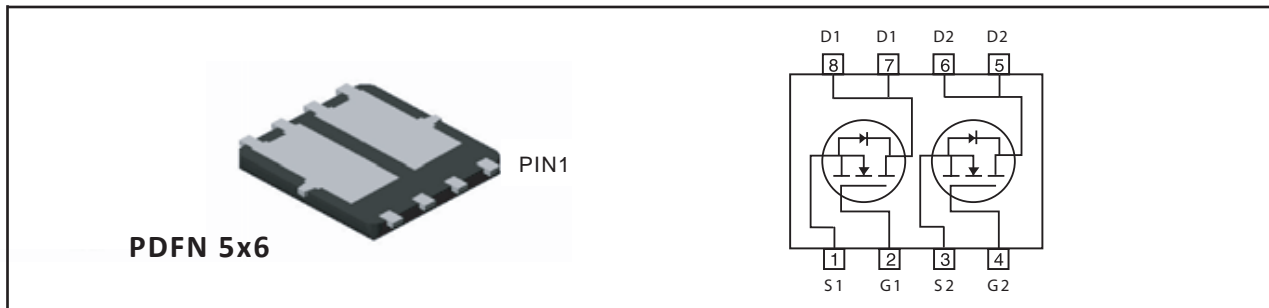

**Dual N-Channel Enhancement Mode Field Effect Transistor****PRODUCT SUMMARY**

V _{DSS}	I _D	R _{DS(ON)} (mΩ) Max
100V	1.6A	390 @ V _{GS} =10V
		460 @ V _{GS} =4.5V

FEATURES

- Super high dense cell design for low R_{DS(ON)}.
- Rugged and reliable.
- Surface Mount Package.

**ABSOLUTE MAXIMUM RATINGS (T_A=25°C unless otherwise noted)**

Symbol	Parameter	Limit	Units
V _{DS}	Drain-Source Voltage	100	V
V _{GS}	Gate-Source Voltage	±20	V
I _D	Drain Current-Continuous ^{a c}	T _A =25°C	1.6
		T _A =70°C	1.28
I _{DM}	-Pulsed ^c	7	A
P _D	Maximum Power Dissipation ^a	T _A =25°C	2.5
		T _A =70°C	1.6
T _J , T _{STG}	Operating Junction and Storage Temperature Range	-55 to 150	°C

THERMAL CHARACTERISTICS

R _{θJA}	Thermal Resistance, Junction-to-Ambient	50	°C/W
------------------	-----------------------------------------	----	------

SP2110

Ver 1.0

ELECTRICAL CHARACTERISTICS (T_A=25°C unless otherwise noted)

Symbol	Parameter	Conditions	Min	Typ	Max	Units
OFF CHARACTERISTICS						
BV _{DSS}	Drain-Source Breakdown Voltage	V _{GS} =0V, I _D =250uA	100			V
I _{DSS}	Zero Gate Voltage Drain Current	V _{DS} =80V, V _{GS} =0V			1	uA
I _{GSS}	Gate-Body Leakage Current	V _{GS} = ±20V, V _{DS} =0V			±100	nA
ON CHARACTERISTICS						
V _{GS(th)}	Gate Threshold Voltage	V _{DS} =V _{GS} , I _D =250uA	1	2	3	V
R _{DS(ON)}	Drain-Source On-State Resistance	V _{GS} =10V, I _D =0.8A		330	390	m ohm
		V _{GS} =4.5V, I _D =0.75A		380	460	m ohm
g _{FS}	Forward Transconductance	V _{DS} =10V, I _D =0.8A		2.3		S
DYNAMIC CHARACTERISTICS^b						
C _{ISS}	Input Capacitance	V _{DS} =25V, V _{GS} =0V f=1.0MHz		250		pF
C _{OSS}	Output Capacitance			25		pF
C _{RSS}	Reverse Transfer Capacitance			16		pF
SWITCHING CHARACTERISTICS^b						
t _{D(ON)}	Turn-On Delay Time	V _{DD} =50V I _D =0.8A V _{GS} =10V R _{GEN} = 6 ohm		7.4		ns
t _r	Rise Time			8.5		ns
t _{D(OFF)}	Turn-Off Delay Time			16.3		ns
t _f	Fall Time			2		ns
Q _g	Total Gate Charge	V _{DS} =50V, I _D =0.8A, V _{GS} =10V		4.4		nC
		V _{DS} =50V, I _D =0.8A, V _{GS} =4.5V		2.5		nC
Q _{gs}	Gate-Source Charge	V _{DS} =50V, I _D =0.8A, V _{GS} =10V		0.8		nC
Q _{gd}	Gate-Drain Charge			1.3		nC
DRAIN-SOURCE DIODE CHARACTERISTICS AND MAXIMUM RATINGS						
V _{SD}	Diode Forward Voltage	V _{GS} =0V, I _S =1A		0.82	1.2	V

Notes

- a.Surface Mounted on FR4 Board of 1 inch², 1oz.
- b.Guaranteed by design, not subject to production testing.
- c.Drain current limited by maximum junction temperature.

Mar,03,2014

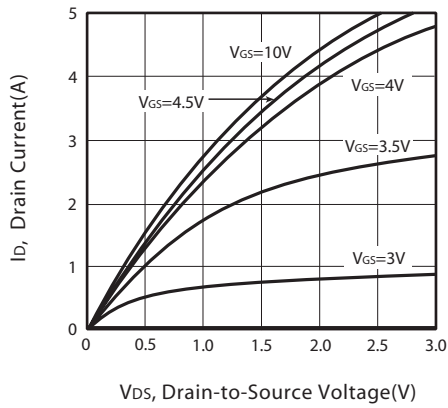

Figure 1. Output Characteristics

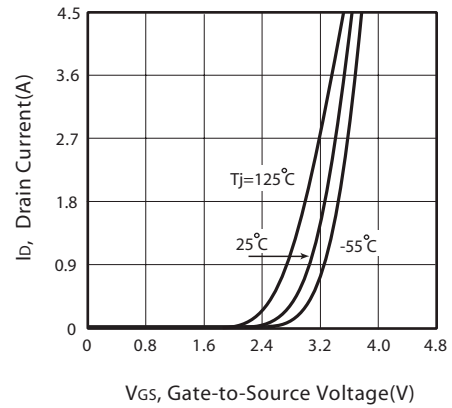

Figure 2. Transfer Characteristics

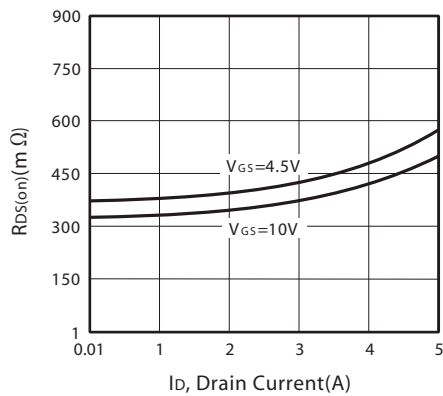

Figure 3. On-Resistance vs. Drain Current and Gate Voltage

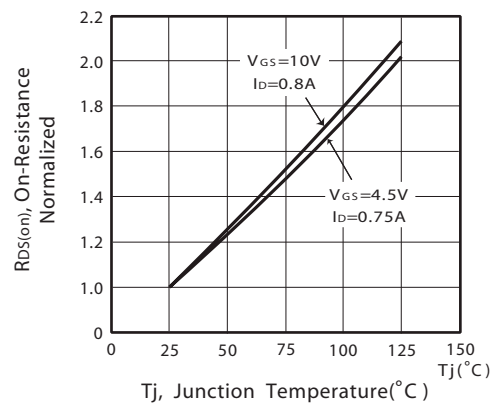

Figure 4. On-Resistance Variation with Drain Current and Temperature

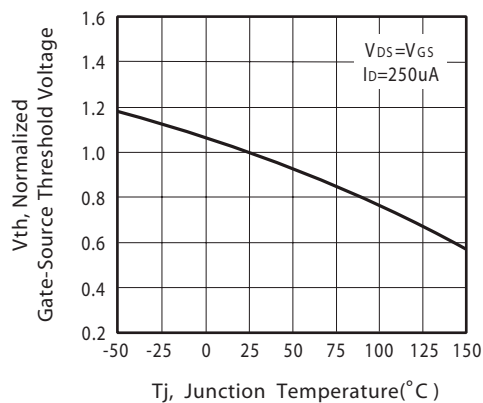

Figure 5. Gate Threshold Variation with Temperature

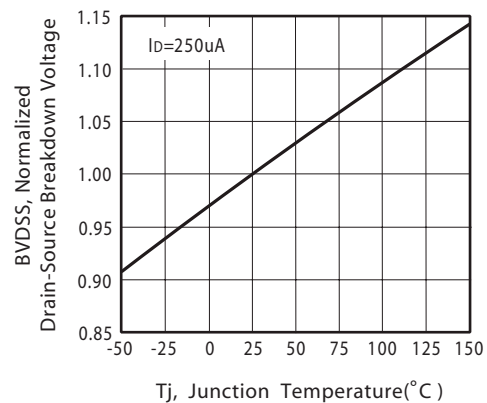

Figure 6. Breakdown Voltage Variation with Temperature

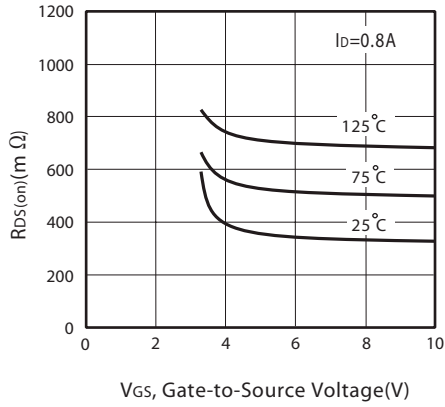

Figure 7. On-Resistance vs. Gate-Source Voltage

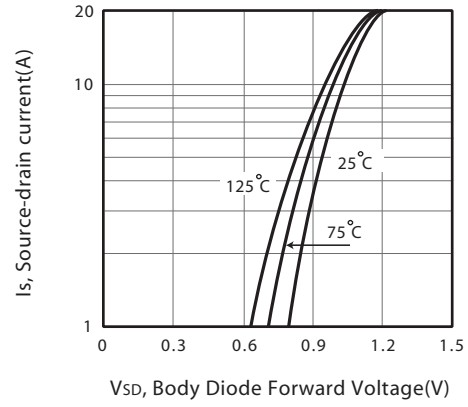

Figure 8. Body Diode Forward Voltage Variation with Source Current

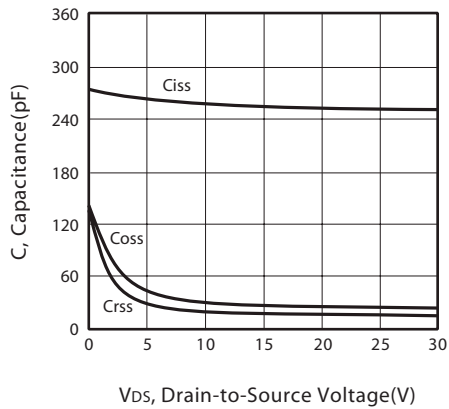

Figure 9. Capacitance

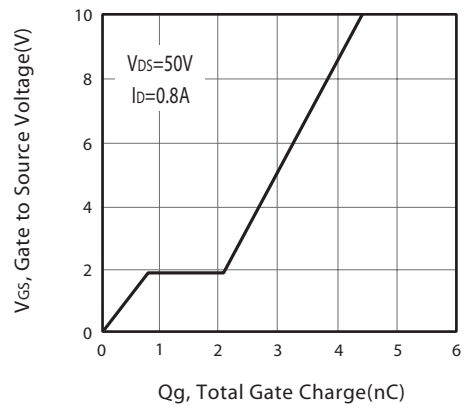

Figure 10. Gate Charge

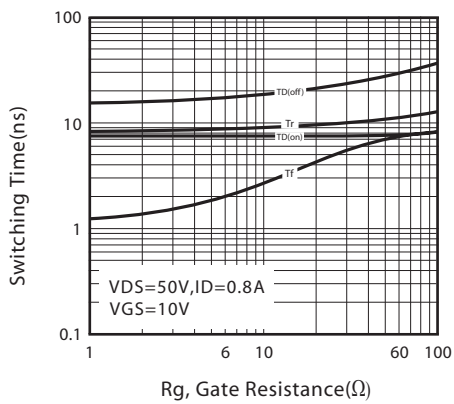

Figure 11. switching characteristics

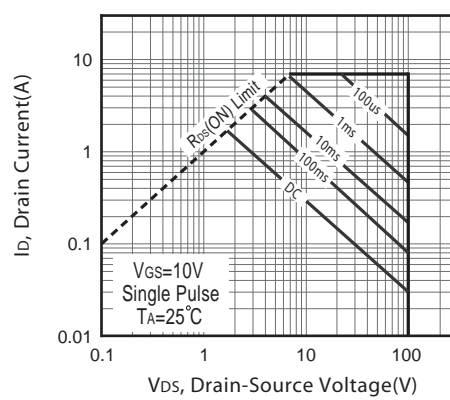

Figure 12. Maximum Safe Operating Area

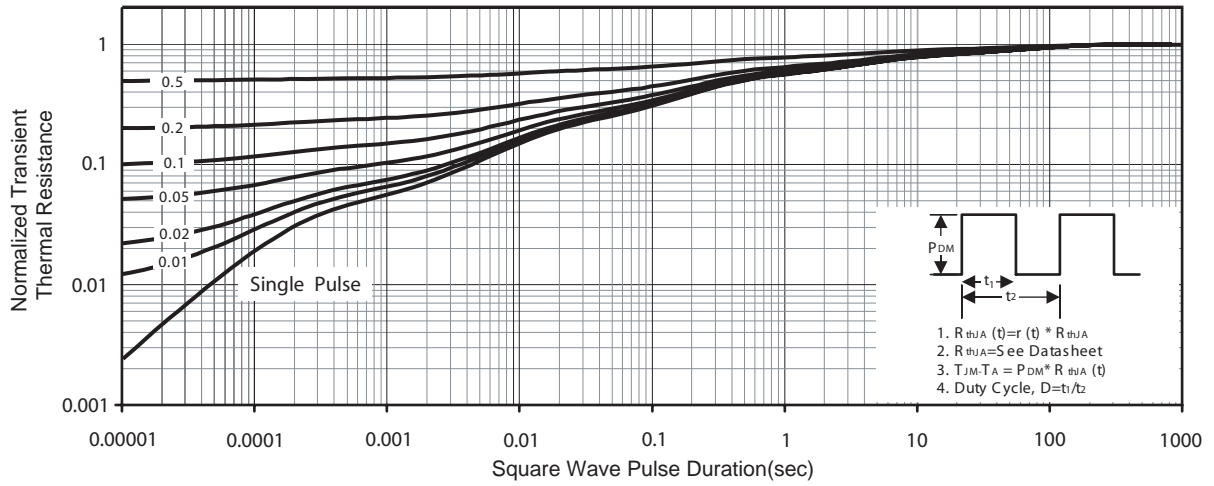
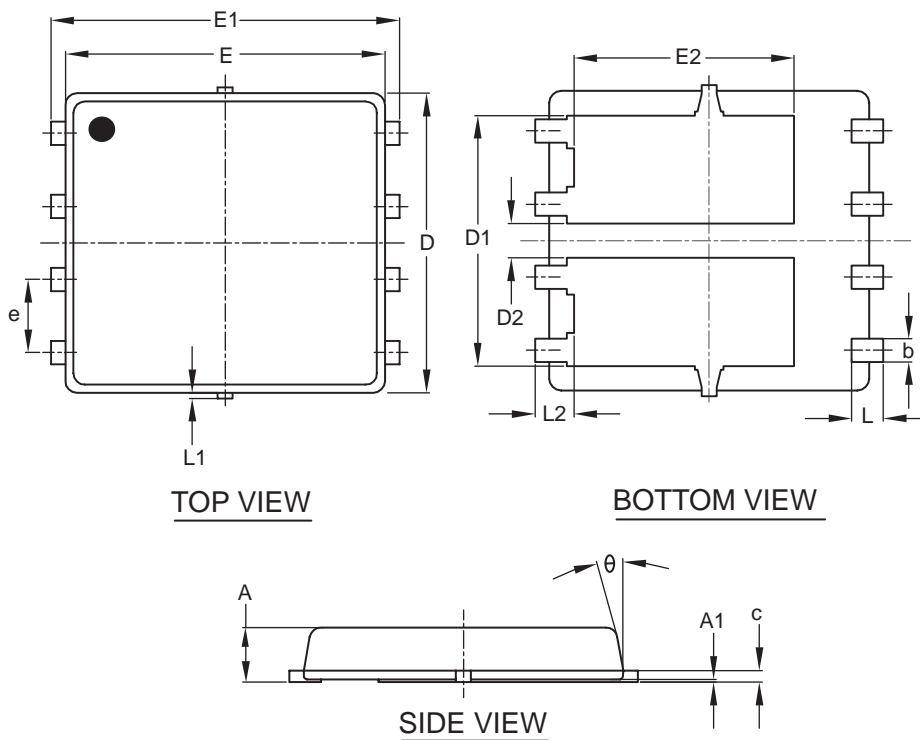

Figure 13. Normalized Thermal Transient Impedance Curve

PACKAGE OUTLINE DIMENSIONS

PDFN 5x6-8L



SYMBOLS	MILLIMETERS		
	MIN	NOM	MAX
A	0.85	0.95	1.00
A1	0.00	—	0.05
b	0.30	0.40	0.50
c	0.15	0.20	0.25
D	5.20 BSC		
D1	4.35 BSC		
D2	0.50	0.60	0.75
E	5.55 BSC		
E1	6.05 BSC		
E2	3.82 BSC		
e	1.27 BSC		
L	0.45	0.55	0.65
L1	0.00	—	0.15
L2	0.68 REF		
θ	0°	—	10°

TOP MARKING DEFINITION

