



Dual N-Channel Enhancement Mode Field Effect Transistor

PRODUCT SUMMARY		
V _{DSS}	I _D	R _{DS(ON)} (mΩ) Max
100V	1.2A	390 @ V _{GS} =10V
		430 @ V _{GS} =4.5V

FEATURES

- Super high dense cell design for low R_{DS(ON)}.
- Rugged and reliable.
- Surface Mount Package.



ABSOLUTE MAXIMUM RATINGS (T_A=25°C unless otherwise noted)

Symbol	Parameter	Limit	Units	
V _{DS}	Drain-Source Voltage	100	V	
V _{GS}	Gate-Source Voltage	±20	V	
I _D	Drain Current-Continuous ^{a c}	T _A =25°C	1.2	A
		T _A =70°C	1.0	A
I _{DM}	-Pulsed ^c	8	A	
E _{AS}	Single Pulse Avalanche Energy ^d	0.64	mJ	
P _D	Maximum Power Dissipation ^a	T _A =25°C	1.47	W
		T _A =70°C	0.94	W
T _J , T _{STG}	Operating Junction and Storage Temperature Range	-55 to 150	°C	

THERMAL CHARACTERISTICS

R _{θJA}	Thermal Resistance, Junction-to-Ambient	85	°C/W
------------------	---	----	------

SP2112

Ver 1.0

ELECTRICAL CHARACTERISTICS (T_A=25°C unless otherwise noted)

Symbol	Parameter	Conditions	Min	Typ	Max	Units
OFF CHARACTERISTICS						
BV _{DSS}	Drain-Source Breakdown Voltage	V _{GS} =0V , I _D =250uA	100			V
I _{DSS}	Zero Gate Voltage Drain Current	V _{DS} =80V , V _{GS} =0V			1	uA
I _{GSS}	Gate-Body Leakage Current	V _{GS} = ±20V , V _{DS} =0V			±100	nA
ON CHARACTERISTICS						
V _{GS(th)}	Gate Threshold Voltage	V _{DS} =V _{GS} , I _D =250uA	1	1.7	3	V
R _{DS(ON)}	Drain-Source On-State Resistance	V _{GS} =10V , I _D =0.6A		320	390	m ohm
		V _{GS} =4.5V , I _D =0.55A		350	430	m ohm
g _{FS}	Forward Transconductance	V _{DS} =5V , I _D =0.6A		2		S
DYNAMIC CHARACTERISTICS^b						
C _{ISS}	Input Capacitance	V _{DS} =25V, V _{GS} =0V f=1.0MHz		248		pF
C _{OSS}	Output Capacitance			21		pF
C _{RSS}	Reverse Transfer Capacitance			14		pF
SWITCHING CHARACTERISTICS^b						
t _{D(ON)}	Turn-On Delay Time	V _{DD} =50V I _D =0.6A V _{GS} =10V R _{GEN} = 6 ohm		8		ns
t _r	Rise Time			10		ns
t _{D(OFF)}	Turn-Off Delay Time			16.5		ns
t _f	Fall Time			4		ns
Q _g	Total Gate Charge	V _{DS} =50V, I _D =0.6A, V _{GS} =10V		4.8		nC
		V _{DS} =50V, I _D =0.6A, V _{GS} =4.5V		2.7		nC
Q _{gs}	Gate-Source Charge	V _{DS} =50V, I _D =0.6A, V _{GS} =10V		0.8		nC
Q _{gd}	Gate-Drain Charge			1.3		nC
DRAIN-SOURCE DIODE CHARACTERISTICS AND MAXIMUM RATINGS						
V _{SD}	Diode Forward Voltage	V _{GS} =0V, I _S =1A		0.8	1.2	V

Notes

- Surface Mounted on FR4 Board of 1 inch² , 1oz.
- Guaranteed by design, not subject to production testing.
- Drain current limited by maximum junction temperature.
- Starting T_J=25°C, L=0.5mH, V_{DD} = 50V. (See Figure13)

May,07,2014

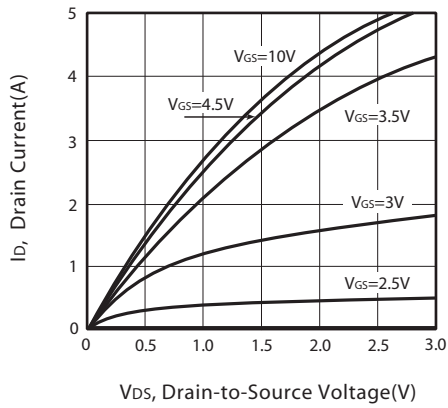

Figure 1. Output Characteristics

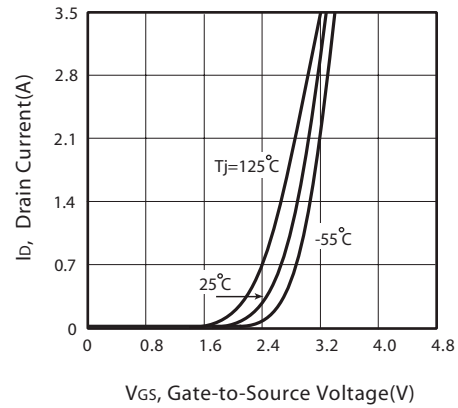

Figure 2. Transfer Characteristics

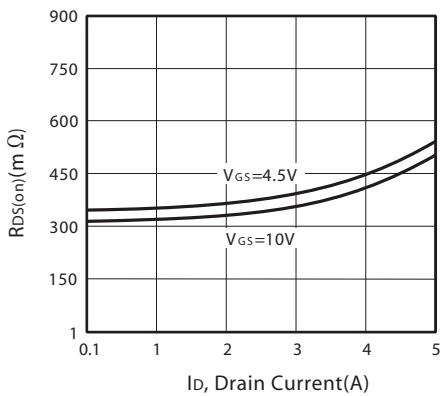

Figure 3. On-Resistance vs. Drain Current and Gate Voltage

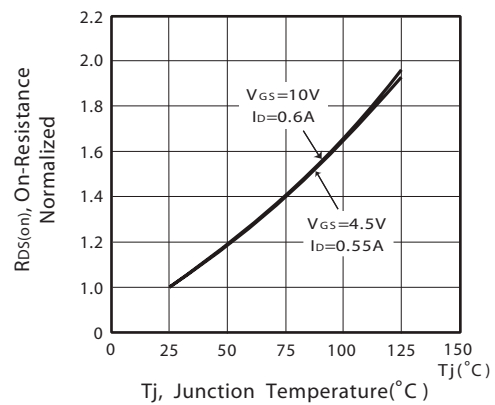

Figure 4. On-Resistance Variation with Drain Current and Temperature

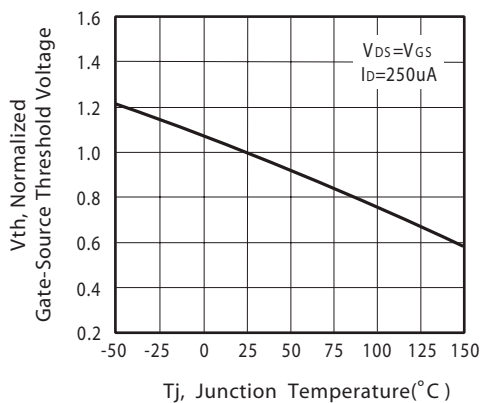

Figure 5. Gate Threshold Variation with Temperature

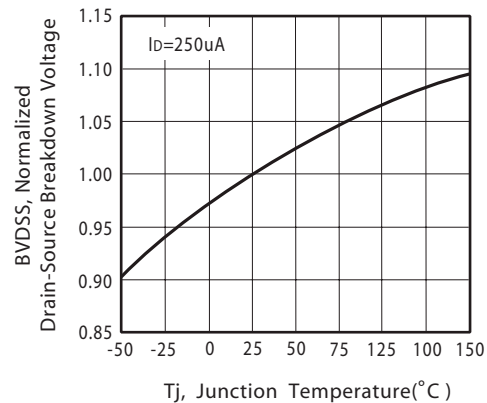

Figure 6. Breakdown Voltage Variation with Temperature

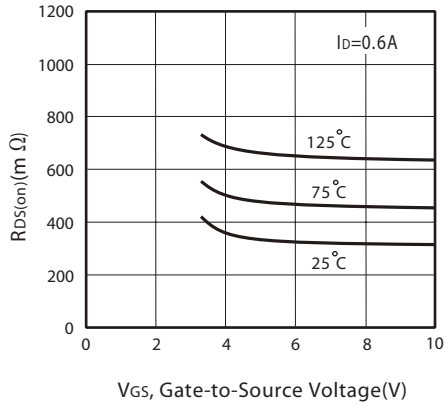

Figure 7. On-Resistance vs. Gate-Source Voltage

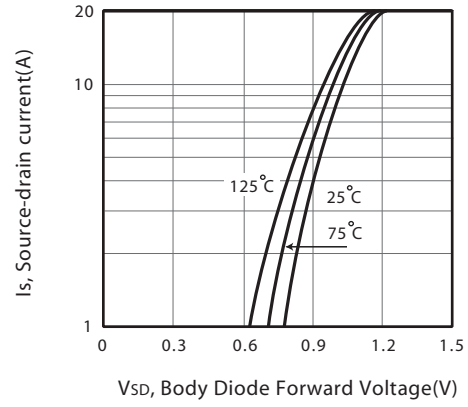

Figure 8. Body Diode Forward Voltage Variation with Source Current

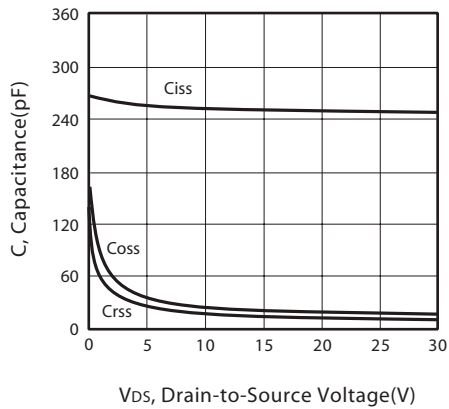

Figure 9. Capacitance

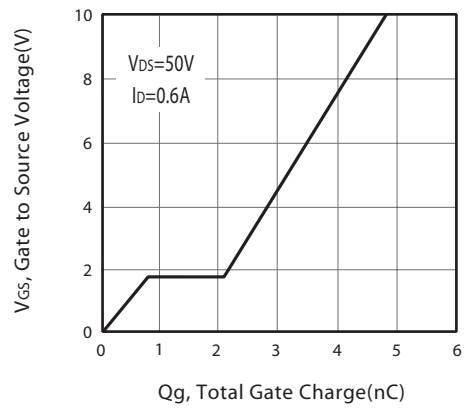

Figure 10. Gate Charge

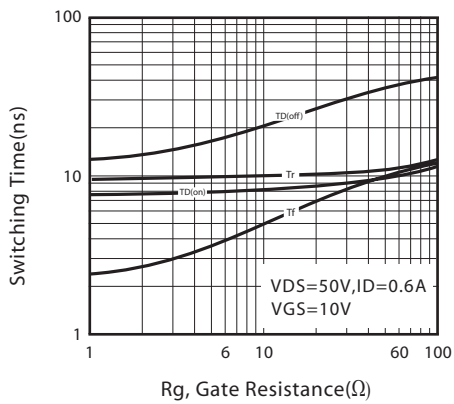

Figure 11. switching characteristics

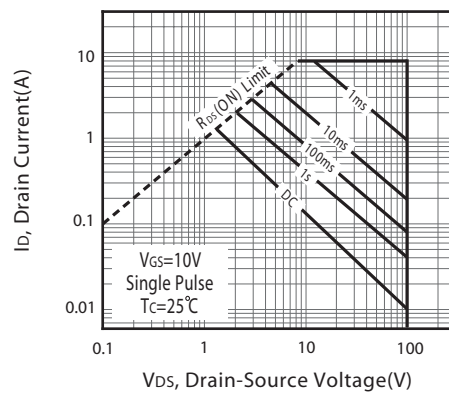
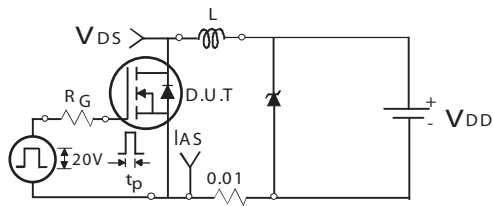
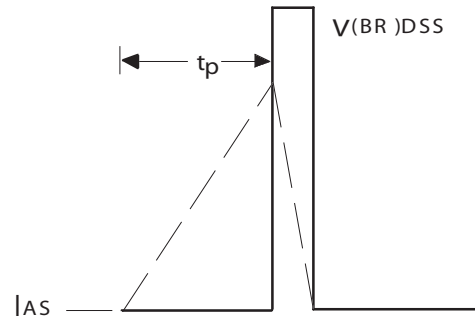

Figure 12. Maximum Safe Operating Area



Unclamped Inductive Test Circuit

Figure 13a.



Unclamped Inductive Waveforms

Figure 13b.

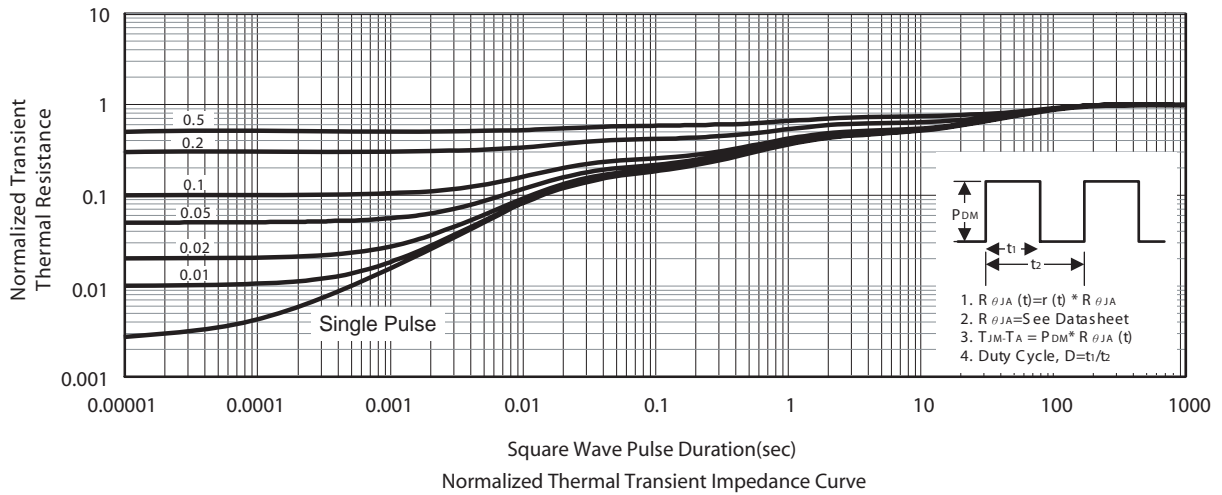

PACKAGE OUTLINE DIMENSIONS

DFN 3x3-8L

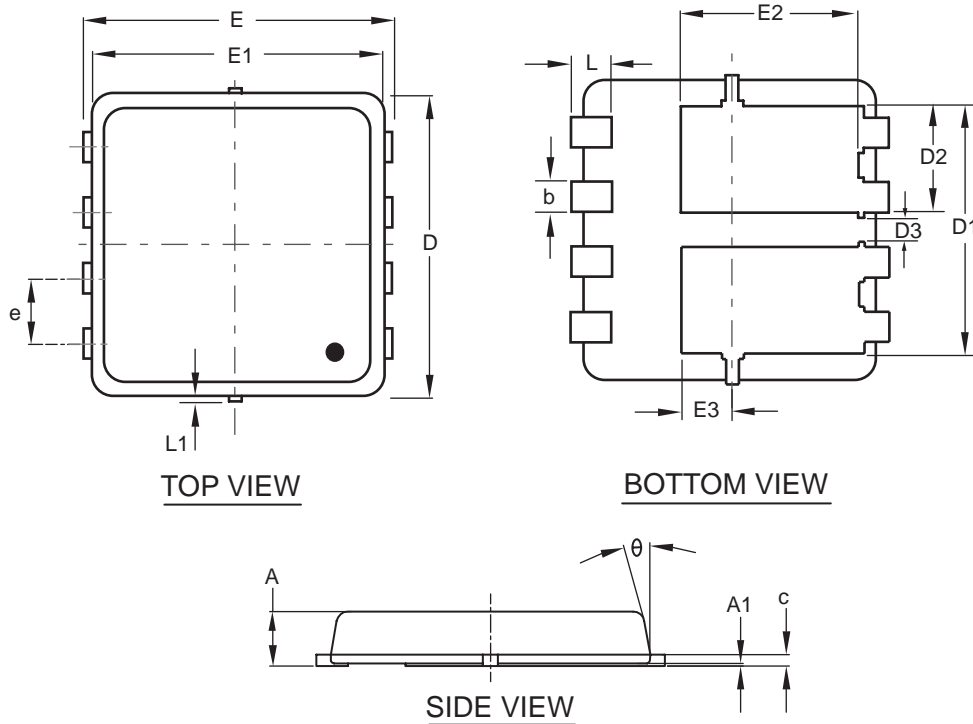

SYMBOLS	MILLIMETERS		
	MIN	NOM	MAX
A	0.70	0.80	0.90
A1	0.00	—	0.05
b	0.24	0.30	0.35
c	0.10	0.152	0.25
D	3.00 BSC		
D1	2.475 BSC		
D2	1.063 BSC		
D3	0.225 BSC		
E	3.20 BSC		
E1	3.00 BSC		
E2	1.813 BSC		
E3	0.525 BSC		
e	0.65 BSC		
L	0.30	0.40	0.50
L1	0.00	—	0.100
θ	0°	10°	12°

TOP MARKING DEFINITION

