



Dual N-Channel Enhancement Mode Field Effect Transistor

PRODUCT SUMMARY		
V _{DSS}	I _D	R _{DS(ON)} (mΩ) Max
60V	5.3A	60 @ V _{GS} = 10V 70 @ V _{GS} = 4.5V

FEATURES

- Super high dense cell design for low R_{DS(ON)}.
- Rugged and reliable.
- Surface Mount Package.
- ESD Protected.

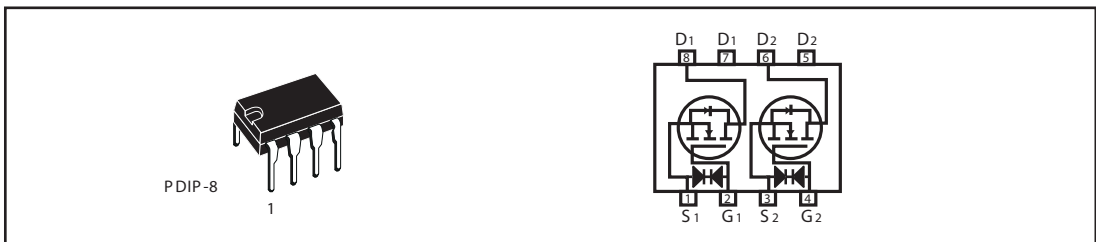

ABSOLUTE MAXIMUM RATINGS (T_A=25°C unless otherwise noted)

Parameter	Symbol	Limit	Unit	
Drain-Source Voltage	V _{DS}	60	V	
Gate-Source Voltage	V _{GS}	±20	V	
Drain Current-Continuous ^a @ T _a	I _D	25°C	5.3	A
		70°C	4.5	A
-Pulsed ^b	I _{DM}	25	A	
Drain-Source Diode Forward Current ^a	I _S	1.7	A	
Maximum Power Dissipation ^a	P _D	T _a =25°C	3	W
		T _a =70°C	2	
Operating Junction and Storage Temperature Range	T _J , T _{STG}	-55 to 150	°C	

THERMAL CHARACTERISTICS

Thermal Resistance, Junction-to-Ambient ^a	R _{θJA}	41.5	°C/W
--	------------------	------	------

STA6968

ELECTRICAL CHARACTERISTICS (T_A 25°C unless otherwise noted)

Parameter	Symbol	Condition	Min	Typ ^c	Max	Unit
OFF CHARACTERISTICS						
Drain-Source Breakdown Voltage	BV _{DSS}	V _{GS} = 0V, I _D = 250uA	60			V
Zero Gate Voltage Drain Current	I _{DSS}	V _{DS} = 48V, V _{GS} = 0V			1	uA
Gate-Body Leakage	I _{GSS}	V _{GS} = ±20V, V _{DS} = 0V			±10	uA
ON CHARACTERISTICS^b						
Gate Threshold Voltage	V _{GS(th)}	V _{DS} = V _{GS} , I _D = 250uA	1.0	1.7	3	V
Drain-Source On-State Resistance	R _{DS(ON)}	V _{GS} = 10V, I _D = 4.5A		49	60	m ohm
		V _{GS} = 4.5V, I _D = 3A		55	70	m ohm
On-State Drain Current	I _{D(ON)}	V _{DS} = 5V, V _{GS} = 10V	20			A
Forward Transconductance	g _{FS}	V _{DS} = 4.5V, I _D = 4.5A		13		S
DYNAMIC CHARACTERISTICS^c						
Input Capacitance	C _{ISS}	V _{DS} = 25V, V _{GS} = 0V f = 1.0MHz		685		pF
Output Capacitance	C _{OSS}			85		pF
Reverse Transfer Capacitance	C _{RSS}			50		pF
Gate resistance	R _g	V _{GS} = 0V, V _{DS} = 0V, f = 1.0MHz		2		ohm
SWITCHING CHARACTERISTICS^c						
Turn-On Delay Time	t _{D(ON)}	V _{DD} = 30V I _D = 4.5 A V _{GS} = 10V R _{GEN} = 6 ohm		11		ns
Rise Time	t _r			12		ns
Turn-Off Delay Time	t _{D(OFF)}			38		ns
Fall Time	t _f			8		ns
Total Gate Charge	Q _g	V _{DS} = 48V, I _D = 4.5A, V _{GS} = 10V		12.7		nC
		V _{DS} = 48V, I _D = 4.5A, V _{GS} = 4.5V		6.9		nC
Gate-Source Charge	Q _{gs}	V _{DS} = 48V, I _D = 4.5 A		1.8		nC
Gate-Drain Charge	Q _{gd}	V _{GS} = 10V		3.6		nC

STA6968

ELECTRICAL CHARACTERISTICS ($T_A=25^{\circ}\text{C}$ unless otherwise noted)

Parameter	Symbol	Condition	Min	Typ ^c	Max	Unit
DRAIN-SOURCE DIODE CHARACTERISTICS^b						
Diode Forward Voltage	V_{SD}	$V_{GS} = 0V, I_s = 1.7A$		0.8	1.2	V

Notes

- a. Surface Mounted on FR4 Board, $t \leq 10\text{sec}$.
- b. Pulse Test: Pulse Width $\leq 300\mu\text{s}$, Duty Cycle $\leq 2\%$.
- c. Guaranteed by design, not subject to production testing.

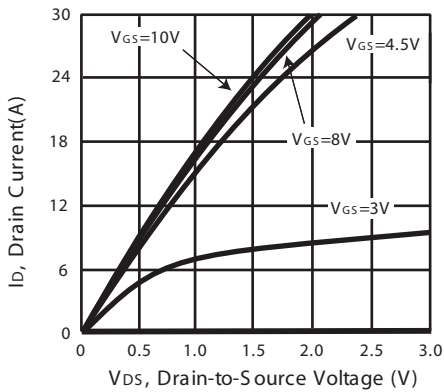

Figure 1. Output Characteristics

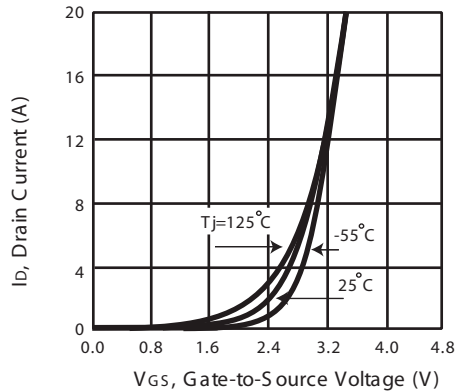

Figure 2. Transfer Characteristics

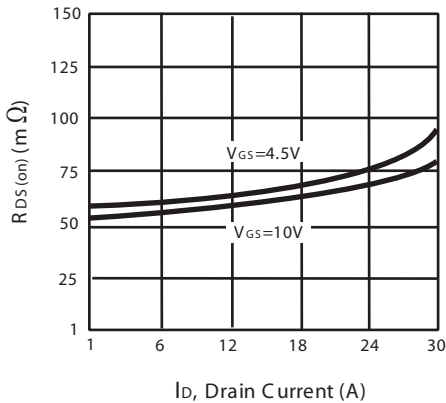

Figure 3. On-Resistance vs. Drain Current and Gate Voltage

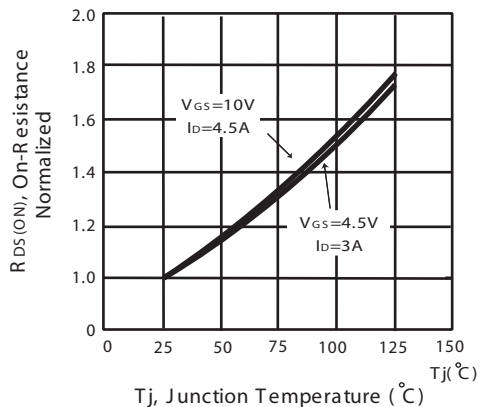

Figure 4. On-Resistance Variation with Drain Current and Temperature

STA6968

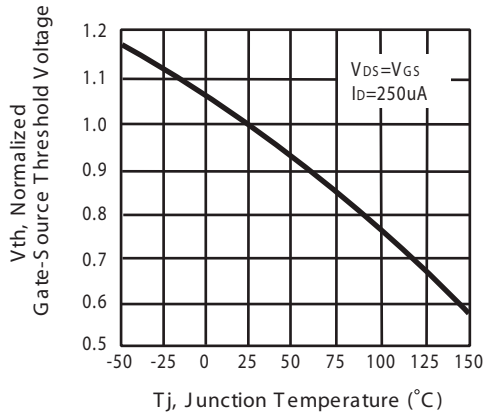

Figure 5. Gate Threshold Variation with Temperature

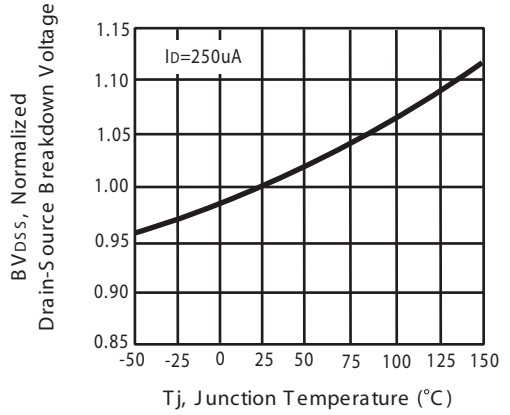

Figure 6. Breakdown Voltage Variation with Temperature

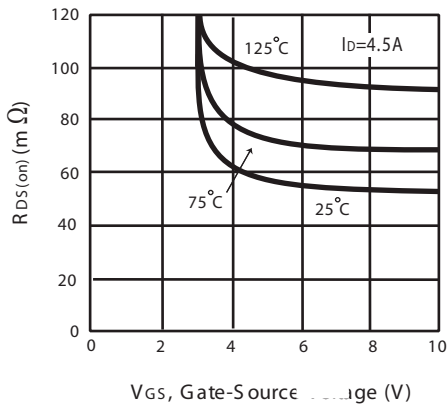

Figure 7. On-Resistance vs. Gate-Source Voltage

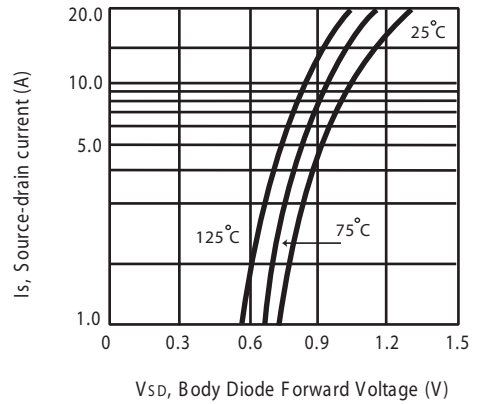

Figure 8. Body Diode Forward Voltage Variation with Source Current

STA6968

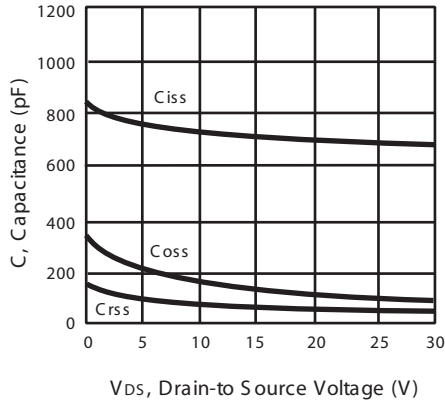

Figure 9. Capacitance

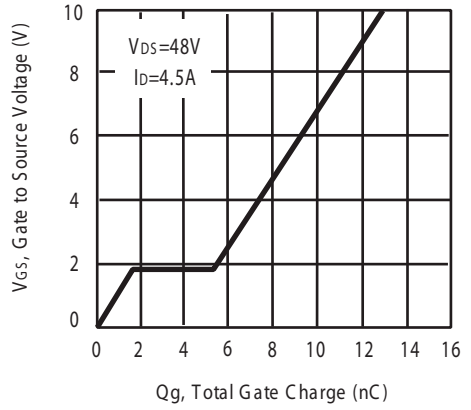

Figure 10. Gate Charge

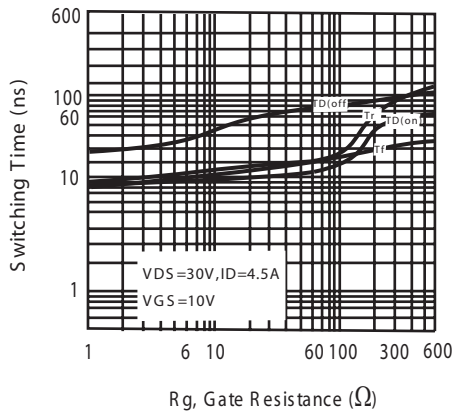

Figure 11. switching characteristics

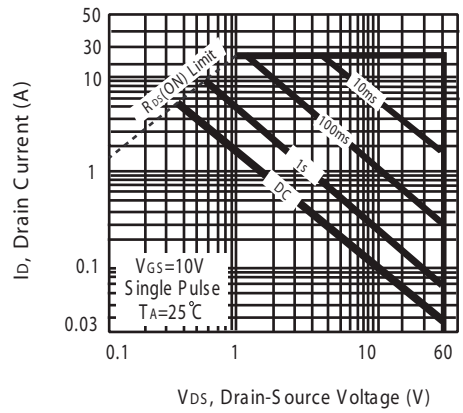
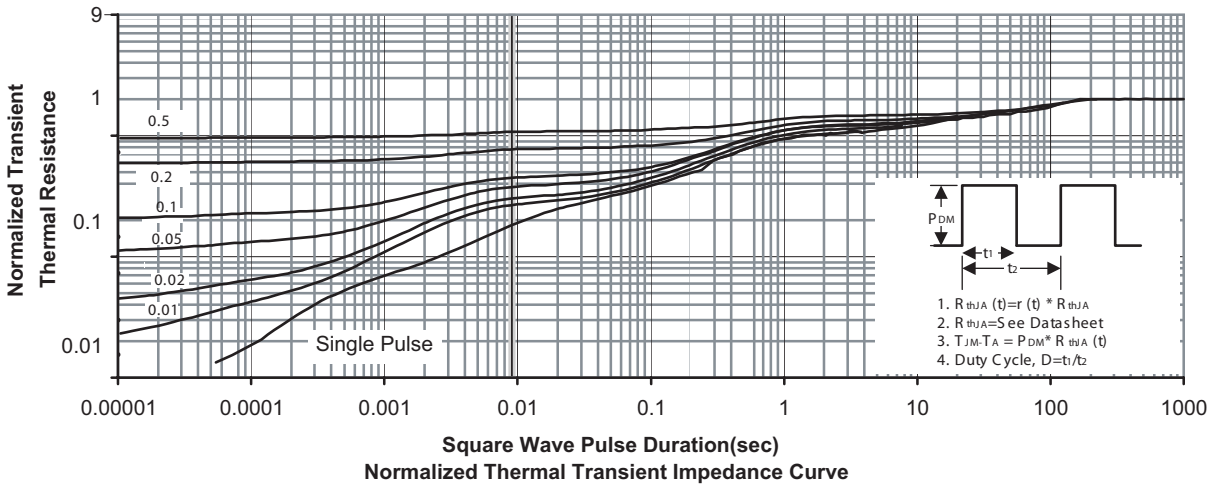

Figure 12. Maximum Safe Operating Area



STA6968

PACKAGE OUTLINE DIMENSIONS

PDIP 8

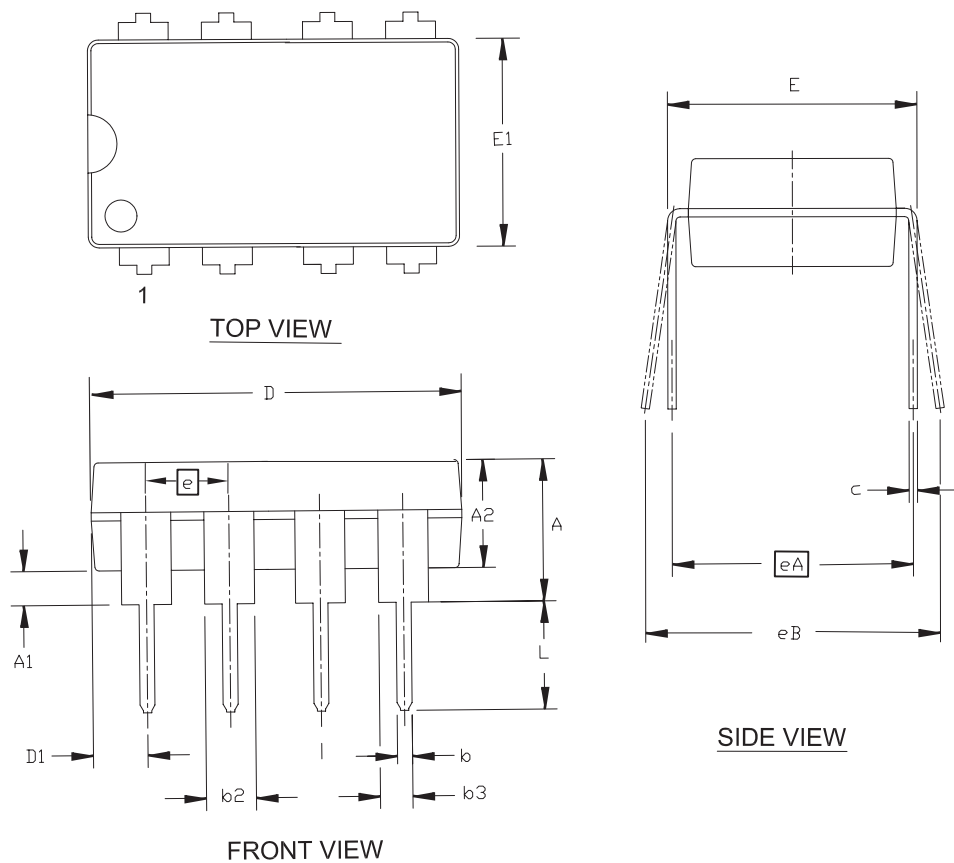

SYMBOL	INCHES			MILLIMETERS		
	MIN	NOM	MAX	MIN	NOM	MAX
A	.145	.172	.200	3.68	4.37	5.08
A1	.020	-	-	0.51	-	-
A2	.125	.130	.135	3.18	3.30	3.43
b	.015	.018	.021	0.38	0.46	0.53
c	.009	.012	.014	0.23	0.30	0.36
b2	.045	.060	.070	1.14	1.52	1.78
b3	.030	.039	.045	0.76	0.99	1.14
L	.125	.132	.140	3.18	3.35	3.56
e	.090	.100	.110	2.29	2.54	2.79
D	.373	.386	.400	9.47	9.80	10.16
D1	.030	.045	.060	0.76	1.14	1.52
E	.300	.310	.320	7.62	7.87	8.13
E1	.245	.250	.255	6.22	6.35	6.48
eA	.280	-	-	7.11	-	-
eB	.310	.325	.365	7.87	8.26	9.27