

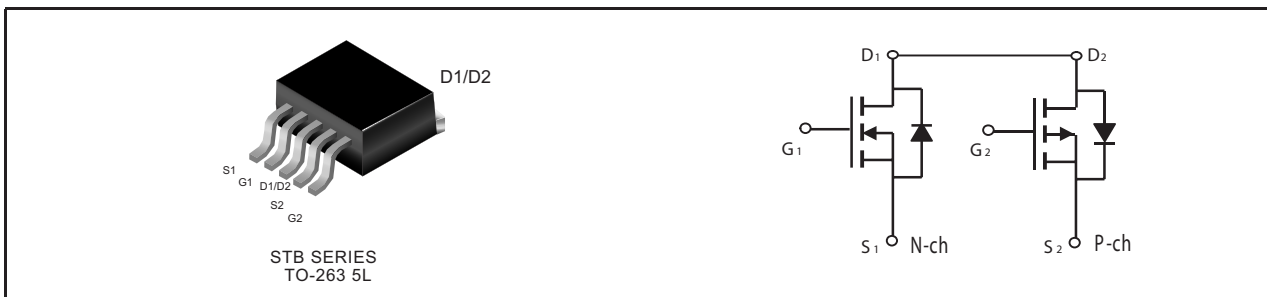

Dual Enhancement Mode Field Effect Transistor (N and P Channel)

PRODUCT SUMMARY (N-Channel)		
VDSS	ID	RDS(ON) (mΩ) Max
40V	30A	10.5 @ VGS=10V
		14 @ VGS=4.5V

PRODUCT SUMMARY (P-Channel)		
VDSS	ID	RDS(ON) (mΩ) Max
-40V	-24A	17 @ VGS=-10V
		24 @ VGS=-4.5V



ABSOLUTE MAXIMUM RATINGS (T_C=25°C unless otherwise noted)

Symbol	Parameter	N-Channel	P-Channel	Units	
V _{DS}	Drain-Source Voltage	40	-40	V	
V _{GS}	Gate-Source Voltage	±20	±20	V	
I _D	Drain Current-Continuous ^a	T _C =25°C	30	-24	A
		T _C =70°C	23.7	-19	A
I _{DM}	-Pulsed ^b	68	-60	A	
E _{AS}	Single Pulse Avalanche Energy ^d	170	210	mJ	
P _D	Maximum Power Dissipation ^a	T _C =25°C	15.6		W
		T _C =70°C	10		W
T _J , T _{STG}	Operating Junction and Storage Temperature Range	-55 to 150		°C	

THERMAL CHARACTERISTICS

R _{θJC}	Thermal Resistance, Junction-to-Case	8	°C/W
R _{θJA}	Thermal Resistance, Junction-to-Ambient	80	°C/W

STB458D

Ver 1.0

N-Channel ELECTRICAL CHARACTERISTICS (T_C=25°C unless otherwise noted)

Symbol	Parameter	Conditions	Min	Typ	Max	Units
OFF CHARACTERISTICS						
BV _{DSS}	Drain-Source Breakdown Voltage	V _{GS} =0V , I _D =250uA	40			V
I _{DSS}	Zero Gate Voltage Drain Current	V _{DS} =32V , V _{GS} =0V			1	A
I _{GSS}	Gate-Body leakage current	V _{GS} = ±20V , V _{DS} =0V			±100	nA
ON CHARACTERISTICS						
V _{GS(th)}	Gate Threshold Voltage	V _{DS} =V _{GS} , I _D =250uA	1	1.9	3	V
R _{DS(ON)}	Drain-Source On-State Resistance	V _{GS} =10V , I _D =15A		8.5	10.5	m ohm
		V _{GS} =4.5V , I _D =13A		10.5	14	m ohm
g _{FS}	Forward Transconductance	V _{DS} =10V , I _D =15A		65		S
DYNAMIC CHARACTERISTICS [°]						
C _{ISS}	Input Capacitance	V _{DS} =20V, V _{GS} =0V f=1.0MHz		1500		pF
C _{OSS}	Output Capacitance			250		pF
C _{RSS}	Reverse Transfer Capacitance			170		pF
SWITCHING CHARACTERISTICS [°]						
t _{D(ON)}	Turn-On DelayTime	V _{DD} =20V I _D =1A V _{GS} =10V R _{GEN} =6 ohm		25		ns
t _r	Rise Time			30		ns
t _{D(OFF)}	Turn-Off DelayTime			65		ns
t _f	Fall Time			40		ns
Q _g	Total Gate Charge	V _{DS} =20V, I _D =15A, V _{GS} =10V		25		nC
		V _{DS} =20V, I _D =15A, V _{GS} =4.5V		12.5		nC
Q _{gs}	Gate-Source Charge	V _{DS} =20V, I _D =15A, V _{GS} =10V		2.6		nC
Q _{gd}	Gate-Drain Charge			7		nC
DRAIN-SOURCE DIODE CHARACTERISTICS AND MAXIMUM RATINGS						
V _{SD}	Diode Forward Voltage	V _{GS} =0V, I _S =6A		0.8	1.3	V

Apr,23,2010

STB458D

Ver 1.0

P-Channel ELECTRICAL CHARACTERISTICS (T_C=25°C unless otherwise noted)

Symbol	Parameter	Conditions	Min	Typ	Max	Units
OFF CHARACTERISTICS						
BV _{DSS}	Drain-Source Breakdown Voltage	V _{GS} =0V, I _D =-250uA	-40			V
I _{DSS}	Zero Gate Voltage Drain Current	V _{DS} =-32V, V _{GS} =0V			-1	uA
I _{GSS}	Gate-Body Leakage Current	V _{GS} = ±20V, V _{DS} =0V			±100	nA
ON CHARACTERISTICS						
V _{GS(th)}	Gate Threshold Voltage	V _{DS} =V _{GS} , I _D =-250uA	-1	-1.6	-3	V
R _{DS(ON)}	Drain-Source On-State Resistance	V _{GS} =-10V, I _D =-12A		13.5	17	m ohm
		V _{GS} =-4.5V, I _D =-10A		18	24	m ohm
g _{FS}	Forward Transconductance	V _{DS} =-10V, I _D =-12A		29		S
DYNAMIC CHARACTERISTICS ^c						
C _{ISS}	Input Capacitance	V _{DS} =-20V, V _{GS} =0V f=1.0MHz		2480		pF
C _{OSS}	Output Capacitance			350		pF
C _{RSS}	Reverse Transfer Capacitance			260		pF
SWITCHING CHARACTERISTICS ^c						
t _{D(ON)}	Turn-On Delay Time	V _{DD} =-20V I _D =-1A V _{GS} =-10V R _{GEN} =3 ohm		39		ns
t _r	Rise Time			70		ns
t _{D(OFF)}	Turn-Off Delay Time			320		ns
t _f	Fall Time			120		ns
Q _g	Total Gate Charge	V _{DS} =-20V, I _D =-12A, V _{GS} =-10V		61		nC
		V _{DS} =-20V, I _D =-12A, V _{GS} =-4.5V		31		nC
Q _{gs}	Gate-Source Charge	V _{DS} =-20V, I _D =-12A,		5		nC
Q _{gd}	Gate-Drain Charge	V _{GS} =-10V		17		nC
DRAIN-SOURCE DIODE CHARACTERISTICS AND MAXIMUM RATINGS						
V _{SD}	Diode Forward Voltage	V _{GS} =0V, I _S =-5A		-0.8	-1.2	V

Notes

- Surface Mounted on FR4 Board, t ≤ 10sec.
- Pulse Test: Pulse Width ≤ 300us, Duty Cycle ≤ 2%.
- Guaranteed by design, not subject to production testing.
- Starting T_J=25°C, L=0.5mH, V_{DD} = 20V, V_{GS}=10V. (See Figure 13)

Apr, 23, 2010

N-Channel

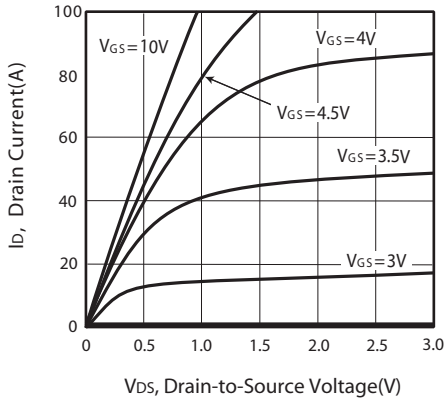

Figure 1. Output Characteristics

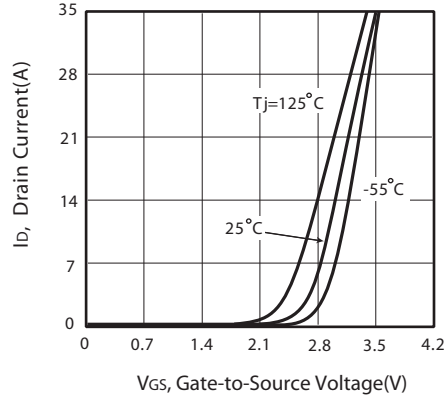

Figure 2. Transfer Characteristics

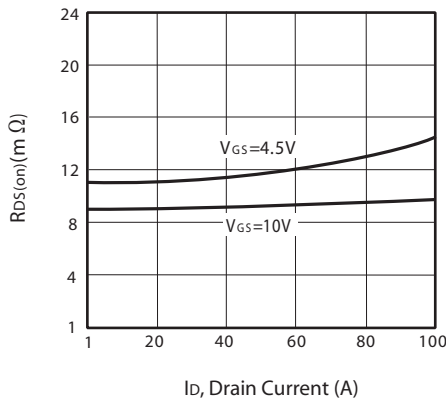

Figure 3. On-Resistance vs. Drain Current and Gate Voltage

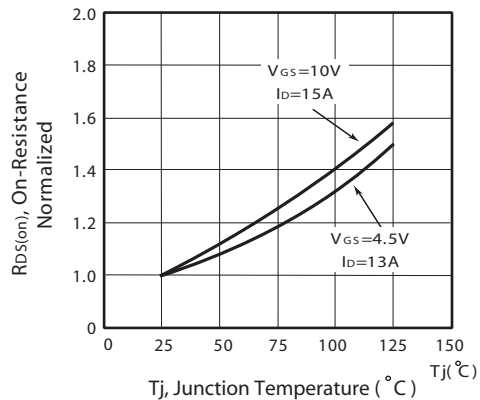

Figure 4. On-Resistance Variation with Drain Current and Temperature

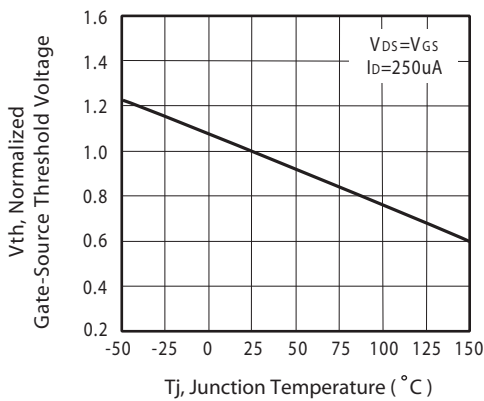

Figure 5. Gate Threshold Variation with Temperature

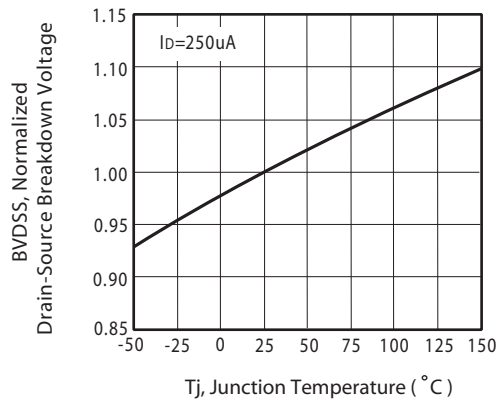

Figure 6. Breakdown Voltage Variation with Temperature

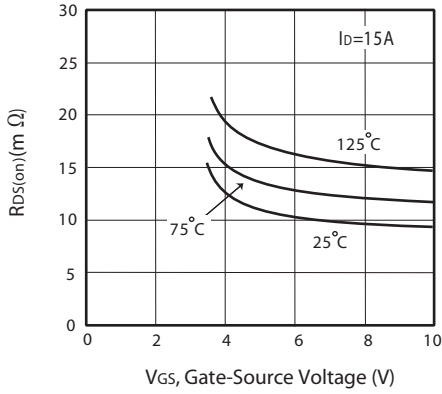

Figure 7. On-Resistance vs. Gate-Source Voltage

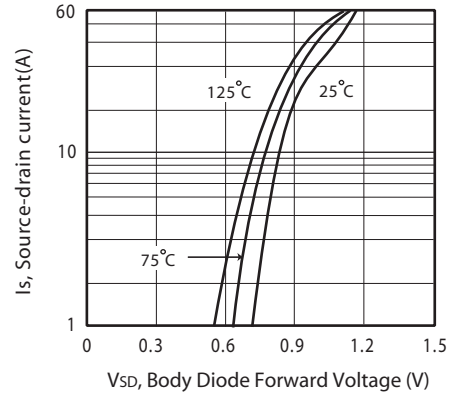

Figure 8. Body Diode Forward Voltage Variation with Source Current

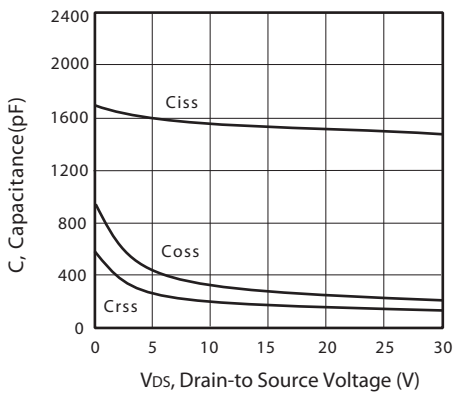

Figure 9. Capacitance

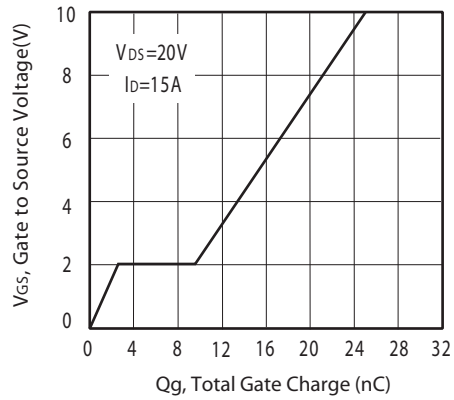

Figure 10. Gate Charge

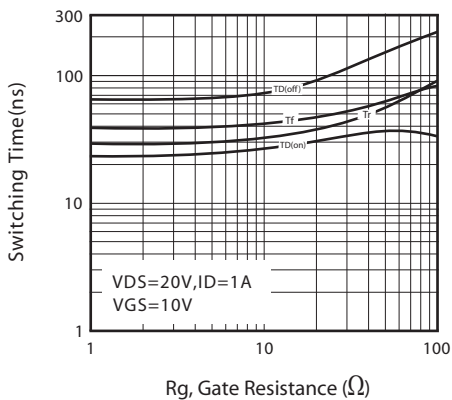

Figure 11. Switching Characteristics

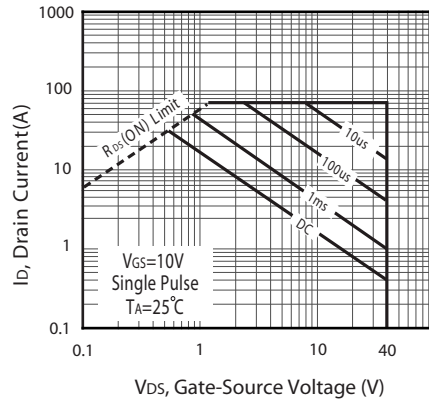
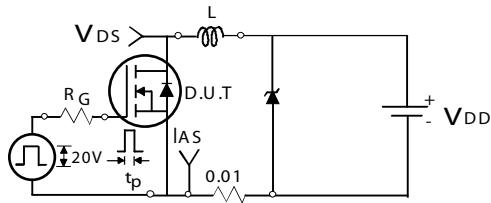
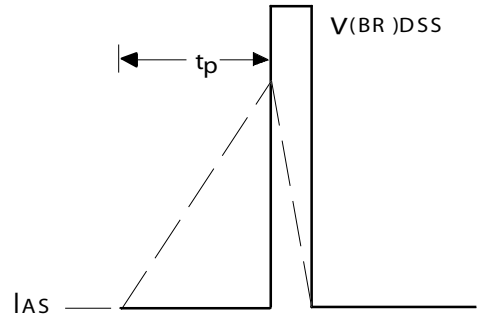

Figure 12. Maximum Safe Operating Area



Unclamped Inductive Test Circuit

Figure 13a.



Unclamped Inductive Waveforms

Figure 13b.

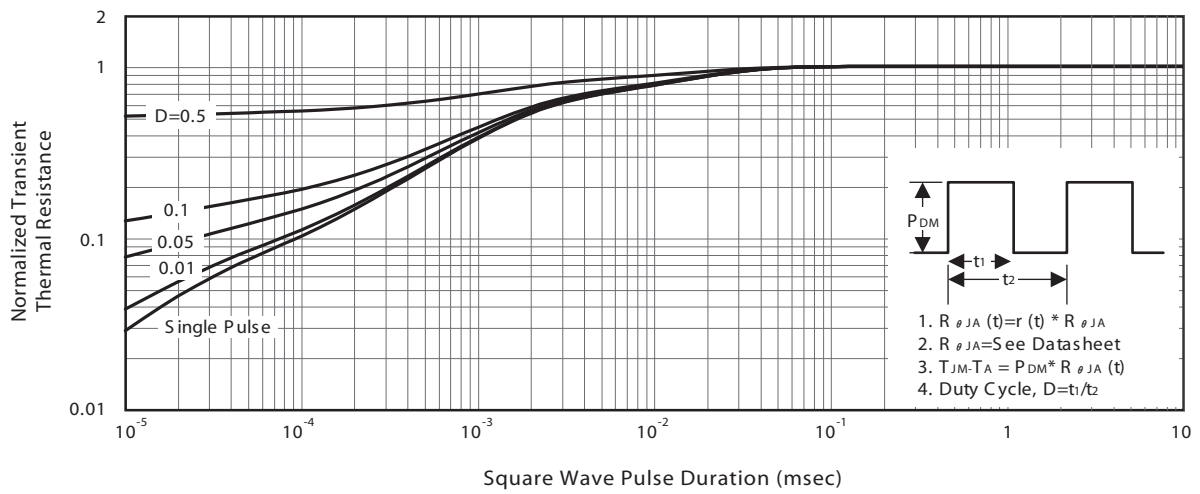

Figure 14. Normalized Thermal Transient Impedance Curve

P-Channel

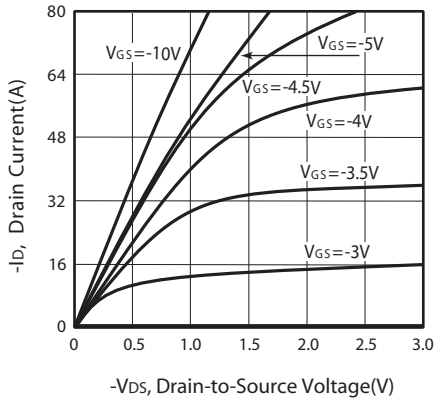

Figure 1. Output Characteristics

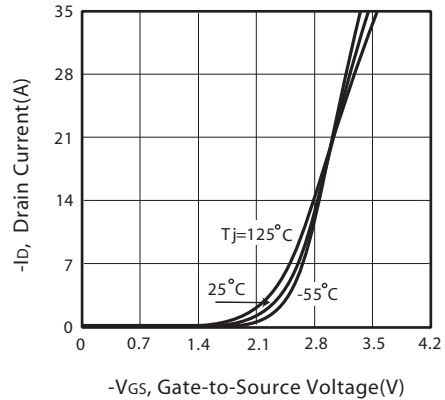

Figure 2. Transfer Characteristics

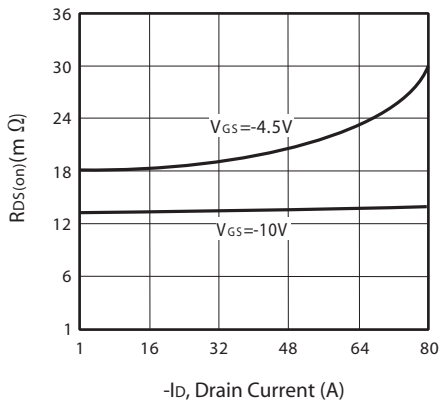

Figure 3. On-Resistance vs. Drain Current and Gate Voltage

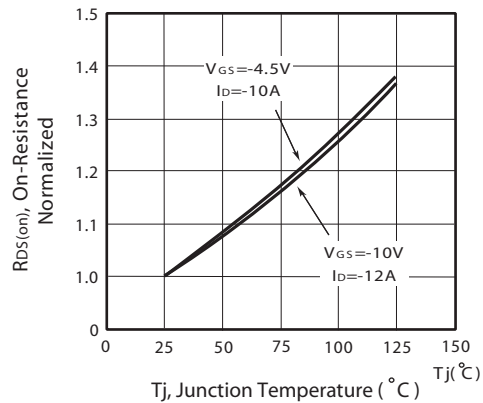

Figure 4. On-Resistance Variation with Drain Current and Temperature

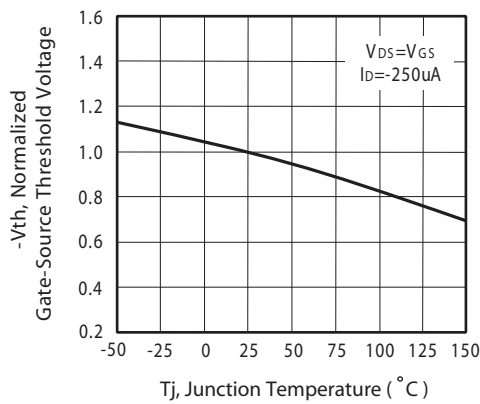

Figure 5. Gate Threshold Variation with Temperature

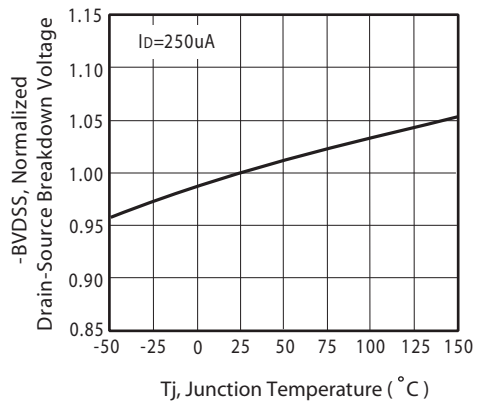

Figure 6. Breakdown Voltage Variation with Temperature

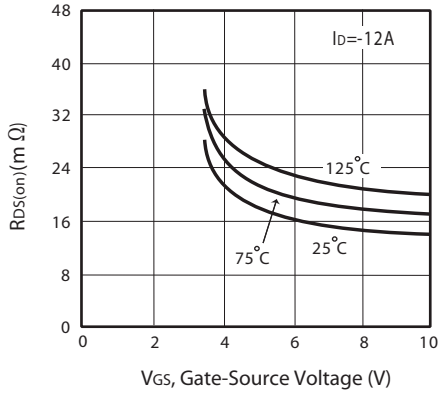

Figure 7. On-Resistance vs. Gate-Source Voltage

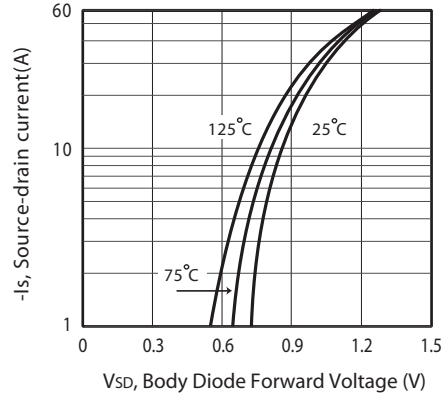

Figure 8. Body Diode Forward Voltage Variation with Source Current

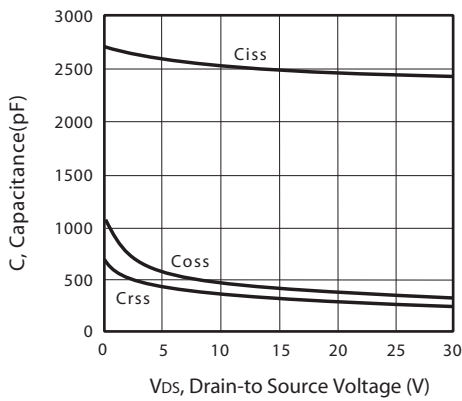

Figure 9. Capacitance

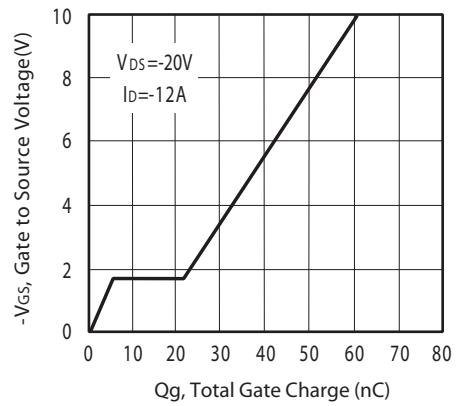

Figure 10. Gate Charge

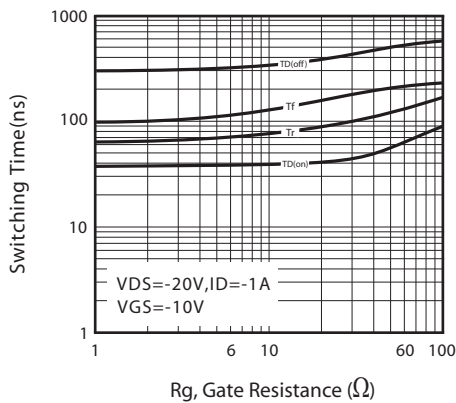

Figure 11. Switching Characteristics

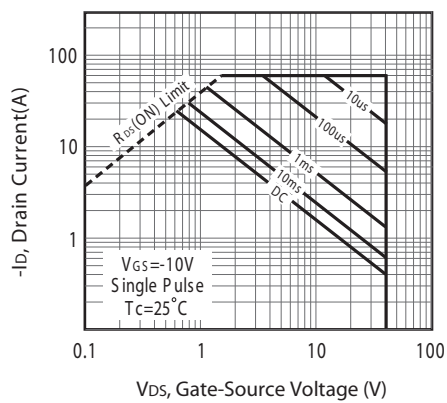
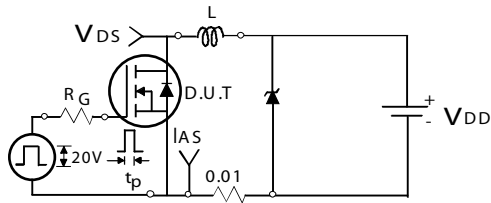
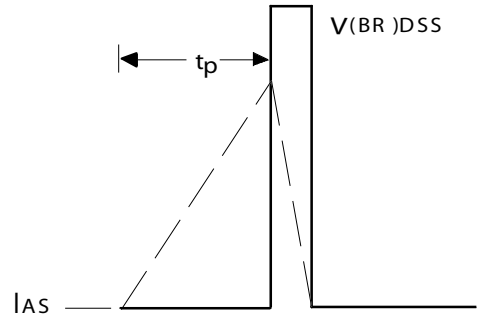

Figure 12. Maximum Safe Operating Area



Unclamped Inductive Test Circuit

Figure 13a.



Unclamped Inductive Waveforms

Figure 13b.

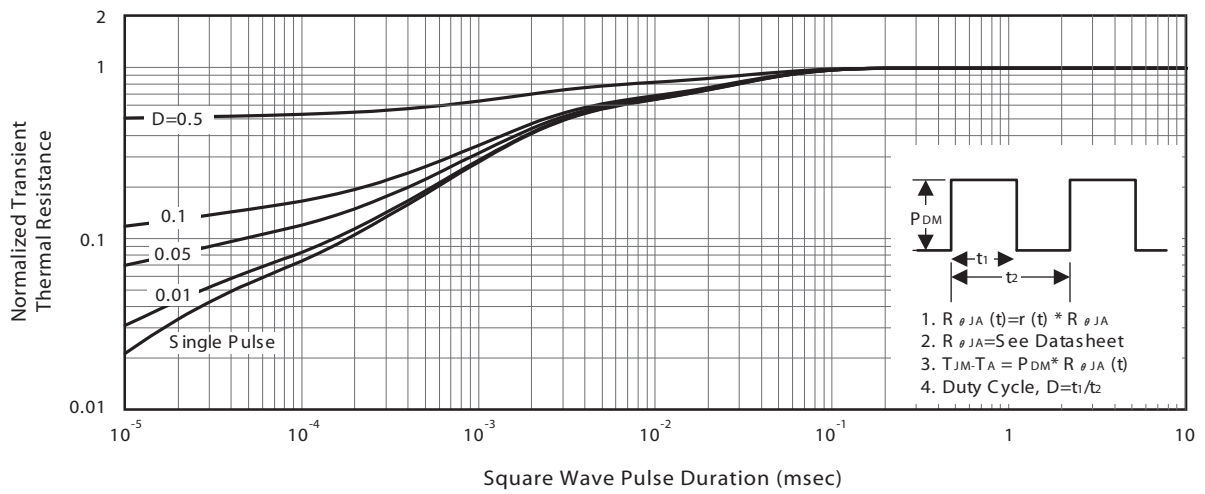

Figure 14. Normalized Thermal Transient Impedance Curve

STB458D

Ver 1.0

PACKAGE OUTLINE DIMENSIONS

TO-263AB

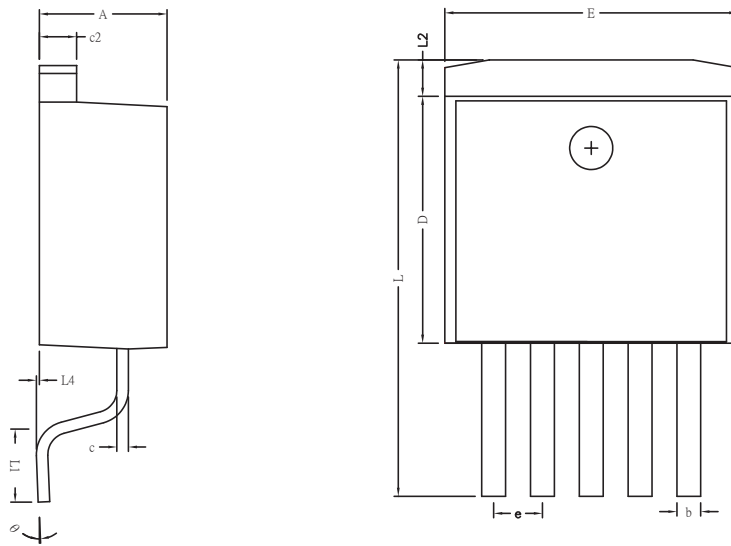

DIMENSIONS

REF.	MILLIMETERS	
	MIN	MAX
A	4.40	4.80
b	0.66	0.91
L4	0.00	0.30
C	0.36	0.50
L3	1.50 REF.	
L1	2.29	2.79
E	9.80	10.4
c2	1.25	1.45
L2	1.27	REF.
D	8.60	9.00
e	1.70 REF.	
L	14.6	15.8
θ	0°	8°

Apr,23,2010

STB458D

Ver1.0

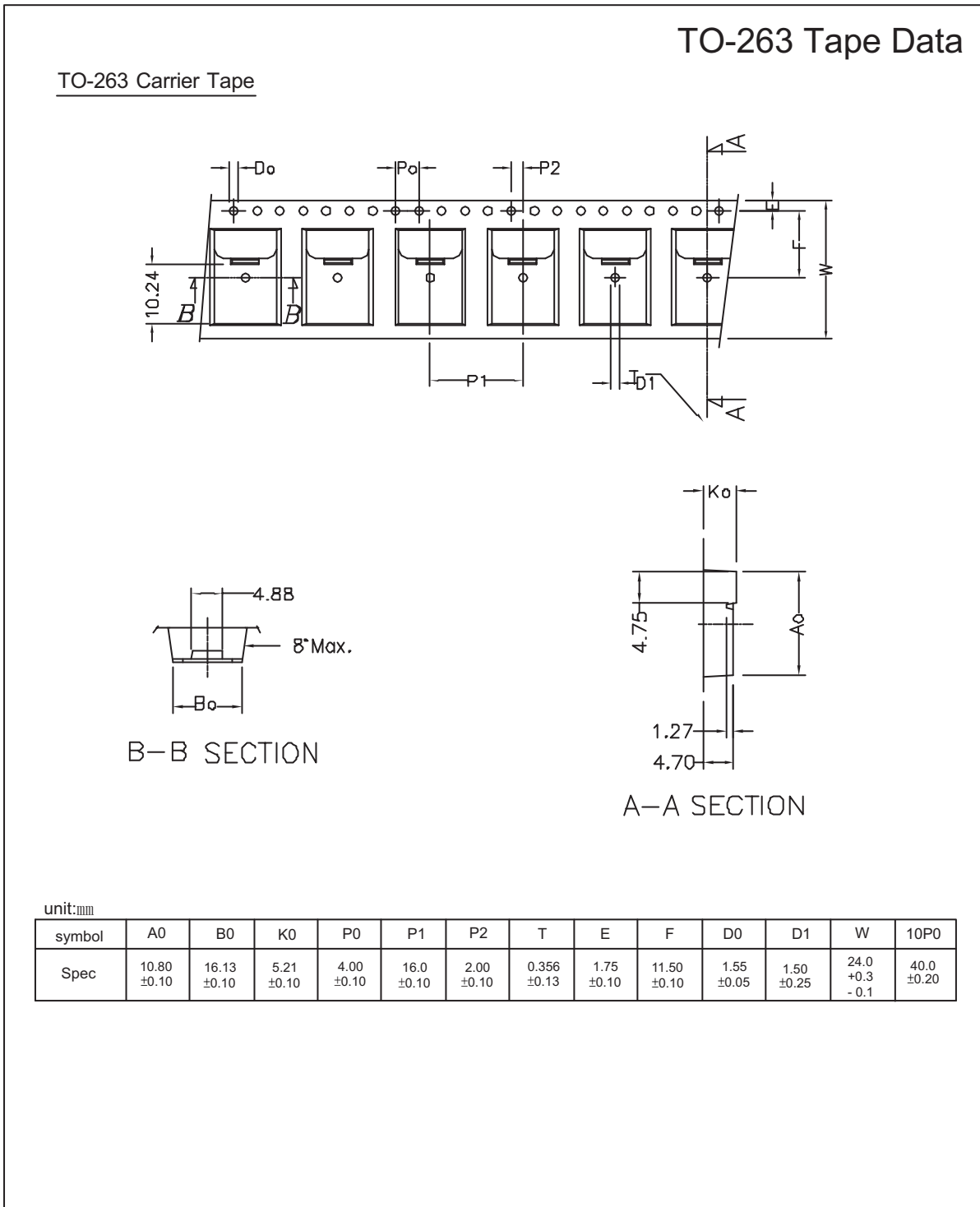

Apr.23,2010