



N-Channel Logic Level Enhancement Mode Field Effect Transistor

PRODUCT SUMMARY

V _{DSS}	I _D	R _{DS(ON)} (mΩ) Max
100V	12A	160 @ V _{GS} =10V

FEATURES

- Super high dense cell design for low R_{DS(ON)}.
- Rugged and reliable.
- TO-251 Package.



ABSOLUTE MAXIMUM RATINGS (T_A=25°C unless otherwise noted)

Symbol	Parameter	Limit	Units
V _{DS}	Drain-Source Voltage	100	V
V _{GS}	Gate-Source Voltage	±20	V
I _D	Drain Current-Continuous ^a	T _C =25°C	12
		T _C =70°C	9.6
I _{DM}	-Pulsed ^b	35	A
E _{AS}	Single Pulse Avalanche Energy ^d	25	mJ
P _D	Maximum Power Dissipation ^a	T _C =25°C	50
		T _C =70°C	32
T _J , T _{STG}	Operating Junction and Storage Temperature Range	-55 to 150	°C

THERMAL CHARACTERISTICS

R _{θJC}	Thermal Resistance, Junction-to-Case ^a	2.5	°C/W
R _{θJA}	Thermal Resistance, Junction-to-Ambient ^a	50	°C/W

STD12L01

Ver 1.3

ELECTRICAL CHARACTERISTICS (TA=25°C unless otherwise noted)

Symbol	Parameter	Conditions	Min	Typ	Max	Units
OFF CHARACTERISTICS						
BV _{DSS}	Drain-Source Breakdown Voltage	V _{GS} =0V , I _D =250uA	100			V
I _{DSS}	Zero Gate Voltage Drain Current	V _{DS} =80V , V _{GS} =0V			1	uA
I _{GSS}	Gate-Body Leakage Current	V _{GS} = ±20V , V _{DS} =0V			±100	nA
ON CHARACTERISTICS						
V _{GS(th)}	Gate Threshold Voltage	V _{DS} =V _{GS} , I _D =250uA	2	2.8	4	V
R _{DS(ON)}	Drain-Source On-State Resistance	V _{GS} =10V , I _D =6A		120	160	m ohm
g _{FS}	Forward Transconductance	V _{DS} =10V , I _D =6A		5		S
DYNAMIC CHARACTERISTICS ^c						
C _{ISS}	Input Capacitance	V _{DS} =25V, V _{GS} =0V f=1.0MHz		520		pF
C _{OSS}	Output Capacitance			47		pF
C _{RSS}	Reverse Transfer Capacitance			29		pF
SWITCHING CHARACTERISTICS ^c						
t _{D(ON)}	Turn-On Delay Time	V _{DD} =50V I _D =1A V _{GS} =10V R _{GEN} = 6 ohm		15.5		ns
t _r	Rise Time			12.2		ns
t _{D(OFF)}	Turn-Off Delay Time			18		ns
t _f	Fall Time			4		ns
Q _g	Total Gate Charge	V _{DS} =50V, I _D =6A, V _{GS} =10V		7.8		nC
Q _{gs}	Gate-Source Charge	V _{DS} =50V, I _D =6A, V _{GS} =10V		1.9		nC
Q _{gd}	Gate-Drain Charge			2.9		nC
DRAIN-SOURCE DIODE CHARACTERISTICS AND MAXIMUM RATINGS						
V _{SD}	Diode Forward Voltage	V _{GS} =0V, I _S =1A		0.775	1.3	V
Notes						
a.Surface Mounted on FR4 Board, t ≤ 10sec. b.Pulse Test:Pulse Width ≤ 300us, Duty Cycle ≤ 2%. c.Guaranteed by design, not subject to production testing. d.Starting T _J =25°C, L=0.5mH, V _{DD} = 50V.(See Figure13)						

Oct,29,2010

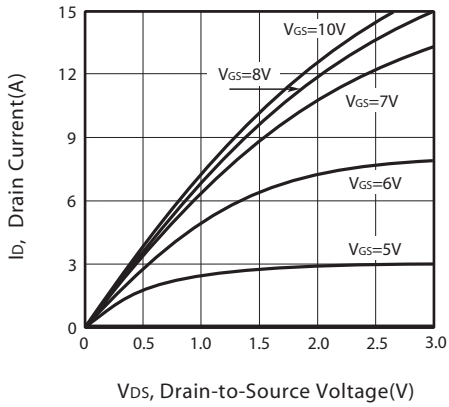

Figure 1. Output Characteristics

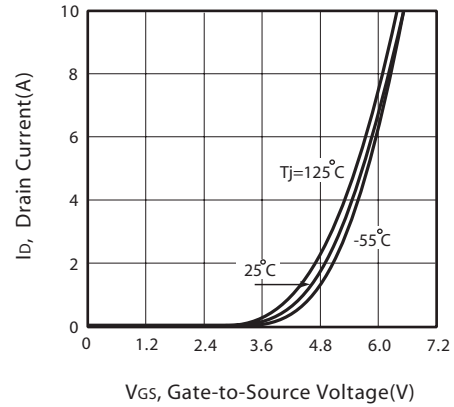

Figure 2. Transfer Characteristics

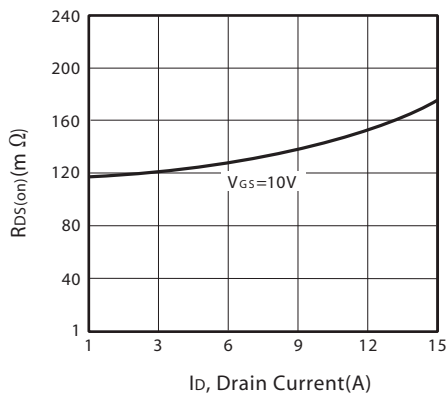

Figure 3. On-Resistance vs. Drain Current and Gate Voltage

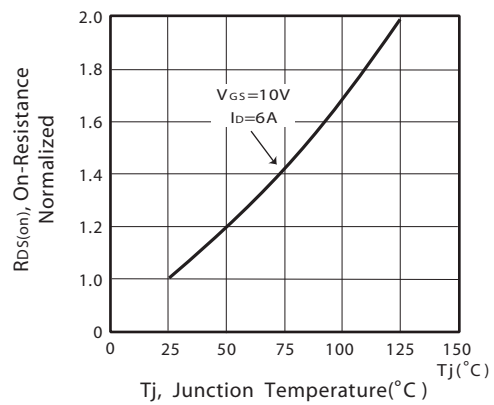

Figure 4. On-Resistance Variation with Drain Current and Temperature

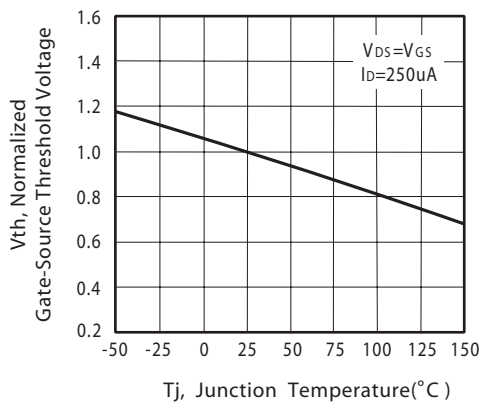

Figure 5. Gate Threshold Variation with Temperature

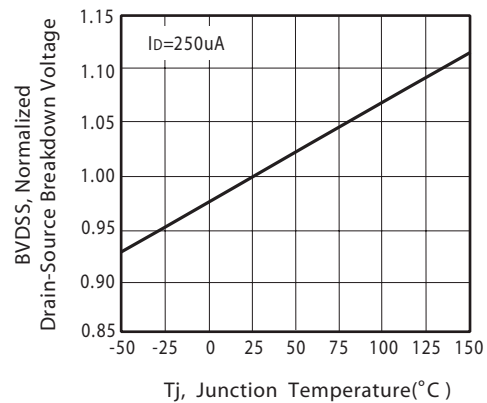
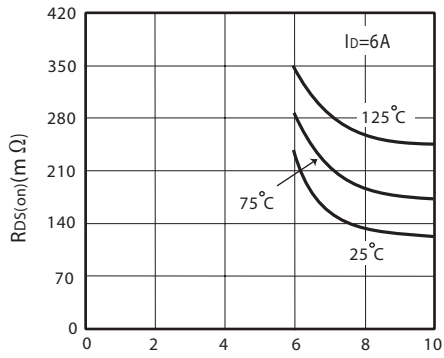
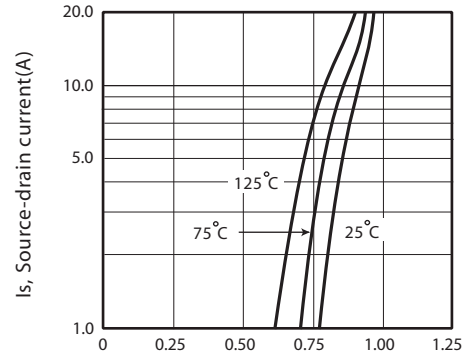

Figure 6. Breakdown Voltage Variation with Temperature



V_{GS} , Gate-to-Source Voltage(V)

Figure 7. On-Resistance vs. Gate-Source Voltage



V_{SD} , Body Diode Forward Voltage(V)

Figure 8. Body Diode Forward Voltage Variation with Source Current

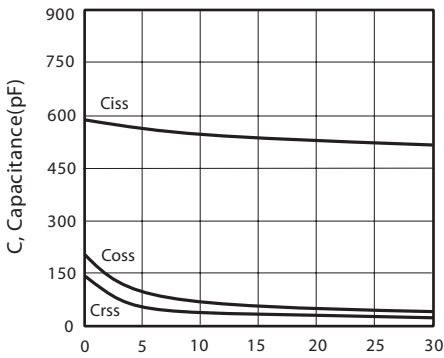

V_{DS} , Drain-to-Source Voltage(V)

Figure 9. Capacitance

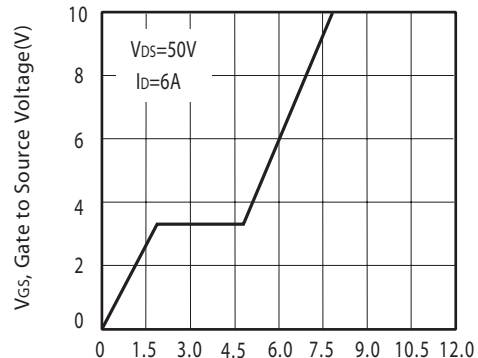

Q_g , Total Gate Charge(nC)

Figure 10. Gate Charge

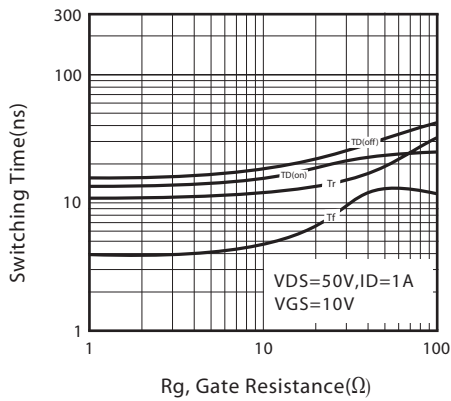

Figure 11. switching characteristics

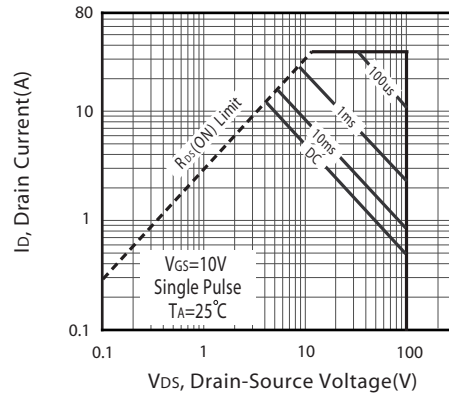
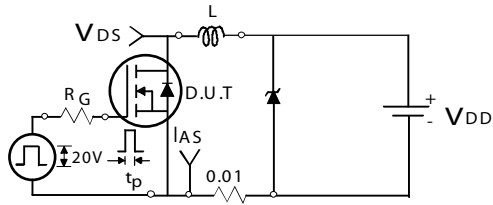

Figure 12. Maximum Safe Operating Area

STD12L01

Ver 1.3



Unclamped Inductive Test Circuit

Figure 13a.

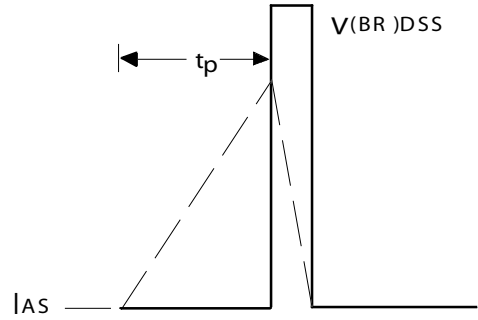

Unclamped Inductive Waveforms

Figure 13b.

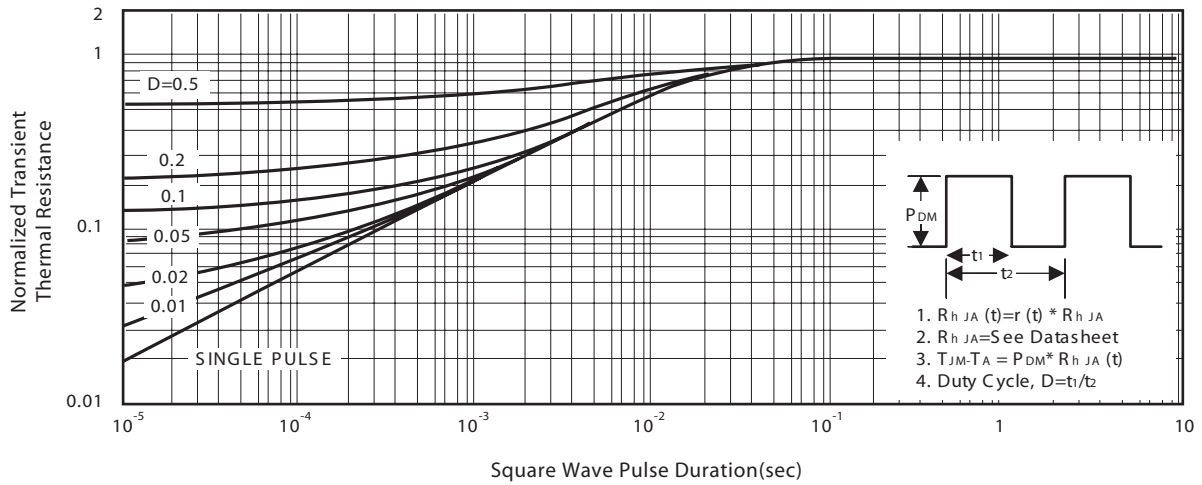

Figure 14. Normalized Thermal Transient Impedance Curve

Oct,29,2010

STD12L01

Ver 1.3

PACKAGE OUTLINE DIMENSIONS

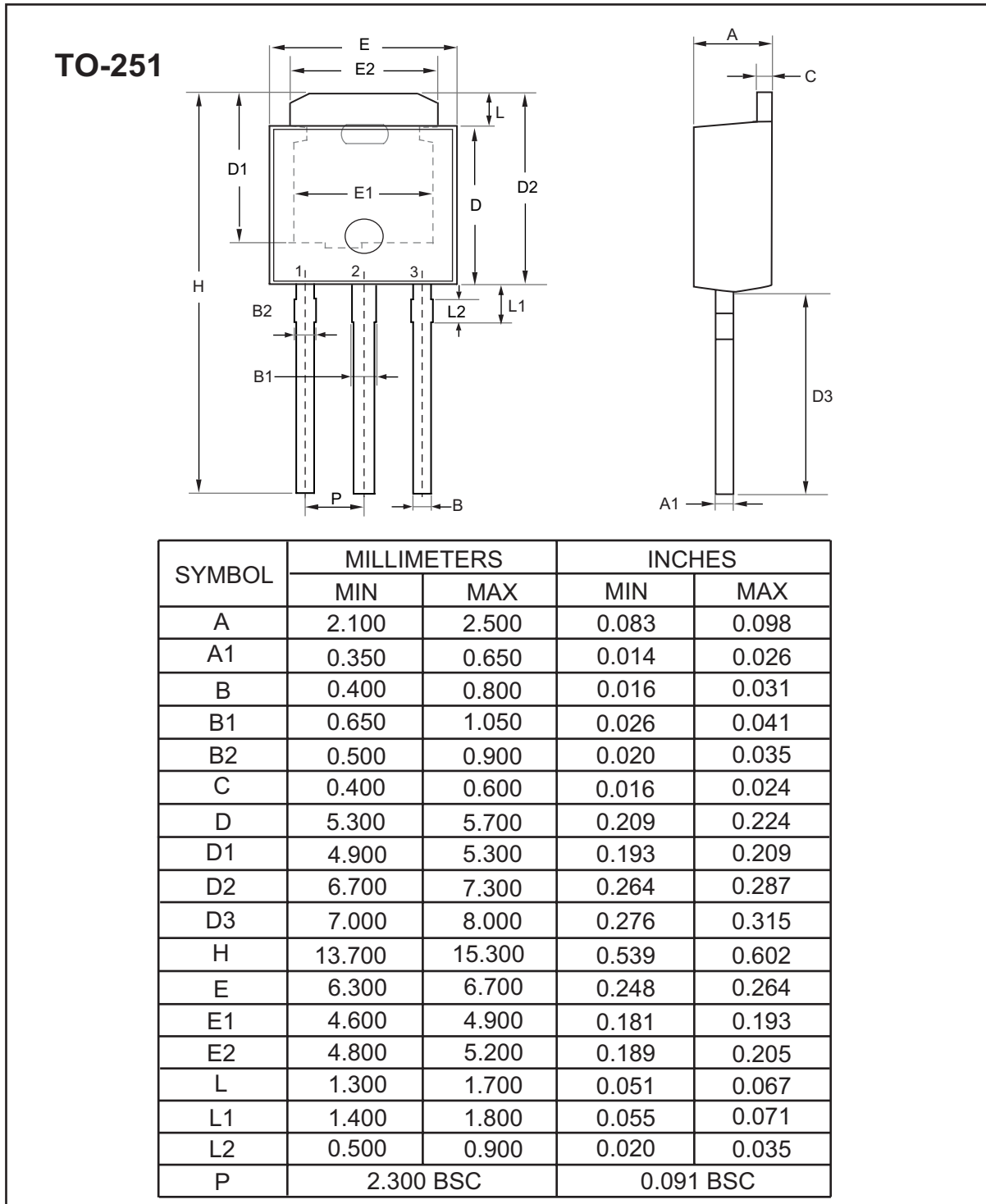

Oct,29,2010

STD12L01

Ver 1.3

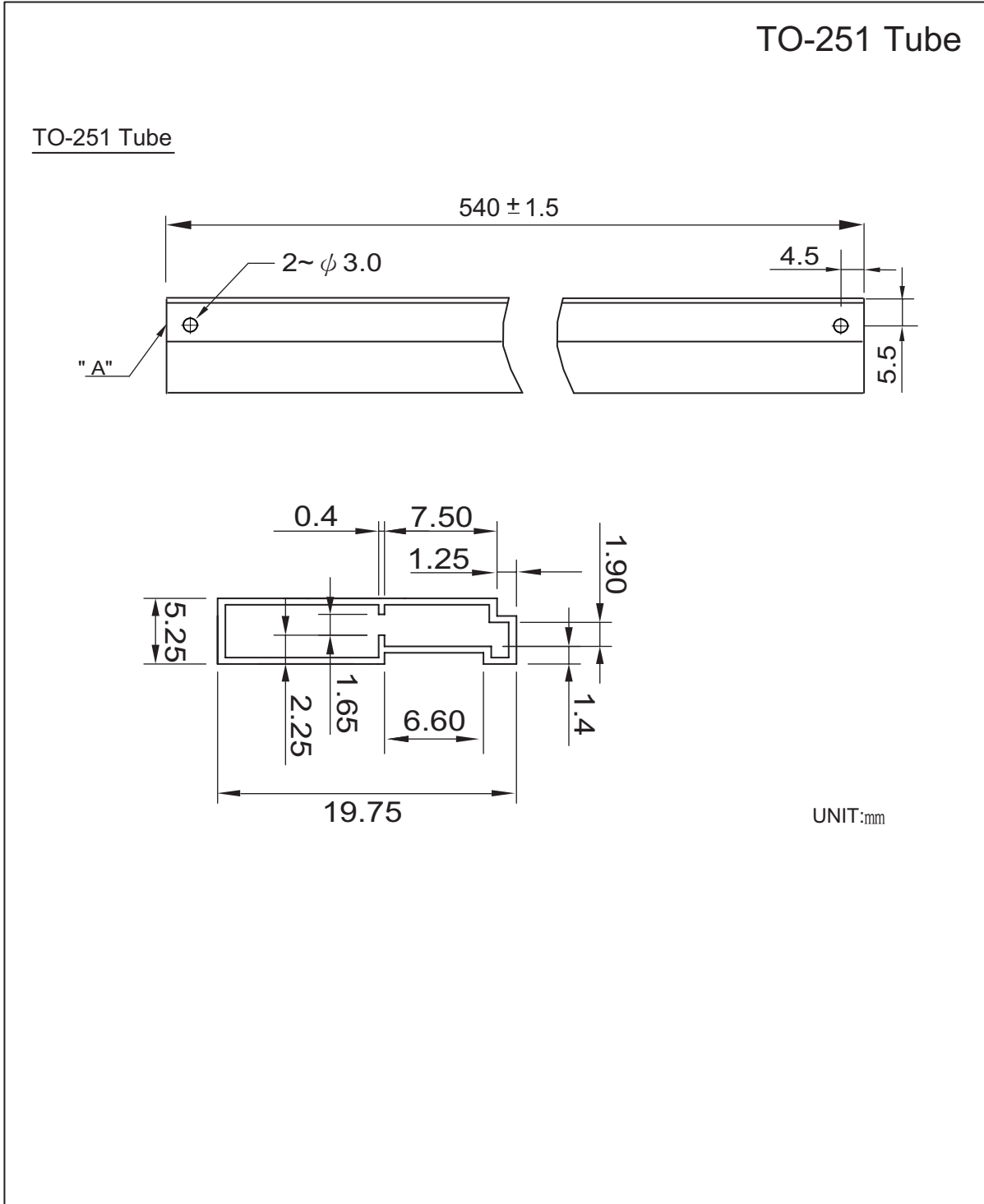

Oct,29,2010