



N-Channel Logic Level Enhancement Mode Field Effect Transistor

PRODUCT SUMMARY

V _{DSS}	I _D	R _{DS(ON)} (mΩ) Max
30V	12A	10.5 @ V _{GS} =10V
		15 @ V _{GS} =4.5V

FEATURES

- Super high dense cell design for low R_{DS(ON)}.
- Rugged and reliable.
- Surface Mount Package.

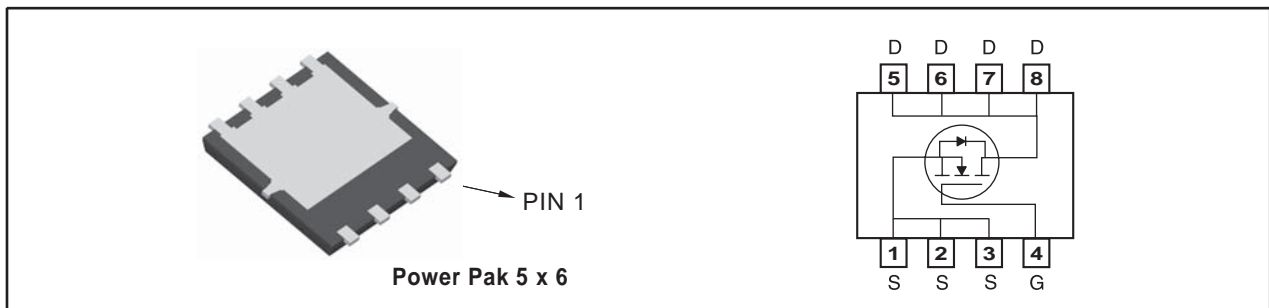

ABSOLUTE MAXIMUM RATINGS (T_A=25°C unless otherwise noted)

Symbol	Parameter	Limit	Units
V _{DS}	Drain-Source Voltage	30	V
V _{GS}	Gate-Source Voltage	±20	V
I _D	Drain Current-Continuous	T _A =25°C	12
		T _A =70°C	9.6
I _{DM}	-Pulsed ^a	42	A
P _D	Maximum Power Dissipation	T _A =25°C	3.1
		T _A =70°C	2
T _J , T _{STG}	Operating Junction and Storage Temperature Range	-55 to 150	°C

THERMAL CHARACTERISTICS

R _{θJA}	Thermal Resistance, Junction-to-Ambient	40	°C/W
------------------	---	----	------

STE339S

Ver 1.0

ELECTRICAL CHARACTERISTICS (T_A=25°C unless otherwise noted)

Symbol	Parameter	Conditions	Min	Typ	Max	Units
OFF CHARACTERISTICS						
BV _{DSS}	Drain-Source Breakdown Voltage	V _{GS} =0V, I _D =250uA	30			V
I _{DSS}	Zero Gate Voltage Drain Current	V _{DS} =24V, V _{GS} =0V			1	uA
I _{GSS}	Gate-Body Leakage Current	V _{GS} = ±20V, V _{DS} =0V			±100	nA
ON CHARACTERISTICS						
V _{GS(th)}	Gate Threshold Voltage	V _{DS} =V _{GS} , I _D =250uA	1	1.8	3	V
R _{DS(ON)}	Drain-Source On-State Resistance	V _{GS} =10V, I _D =6A		9	10.5	m ohm
		V _{GS} =4.5V, I _D =4.6A		12.5	15	m ohm
g _{FS}	Forward Transconductance	V _{DS} =10V, I _D =6A		29		S
DYNAMIC CHARACTERISTICS^b						
C _{ISS}	Input Capacitance	V _{DS} =15V, V _{GS} =0V f=1.0MHz		870		pF
C _{OSS}	Output Capacitance			163		pF
C _{RSS}	Reverse Transfer Capacitance			126		pF
SWITCHING CHARACTERISTICS^b						
t _{D(ON)}	Turn-On Delay Time	V _{DD} =15V I _D =1A		18		ns
t _r	Rise Time			18.2		ns
t _{D(OFF)}	Turn-Off Delay Time	V _{GS} =10V R _{GEN} = 6 ohm		42		ns
t _f	Fall Time			18		ns
Q _g	Total Gate Charge	V _{DS} =15V, I _D =6A, V _{GS} =10V		14.7		nC
		V _{DS} =15V, I _D =6A, V _{GS} =4.5V		7.7		nC
Q _{gs}	Gate-Source Charge	V _{DS} =15V, I _D =6A, V _{GS} =10V		1.7		nC
Q _{gd}	Gate-Drain Charge			4.1		nC
DRAIN-SOURCE DIODE CHARACTERISTICS AND MAXIMUM RATINGS						
V _{SD}	Diode Forward Voltage	V _{GS} =0V, I _S =4A		0.79	1.2	V

Notes

- a. Pulse Test: Pulse Width < 300us, Duty Cycle < 2%.
b. Guaranteed by design, not subject to production testing.

Dec,04,2012

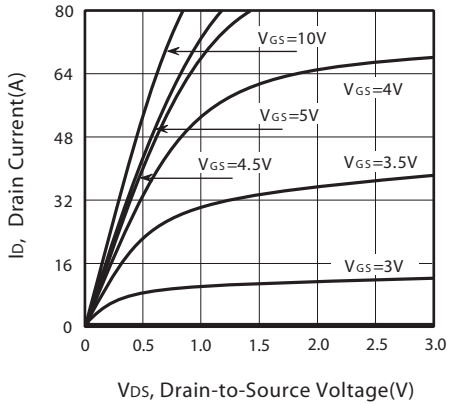

Figure 1. Output Characteristics

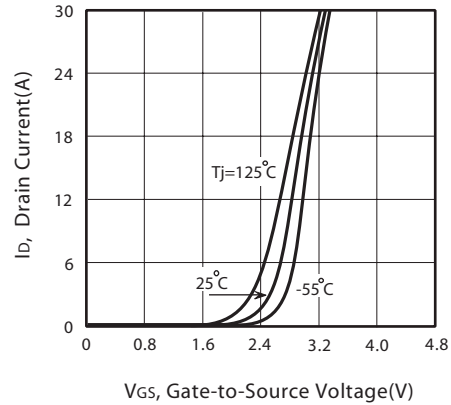

Figure 2. Transfer Characteristics

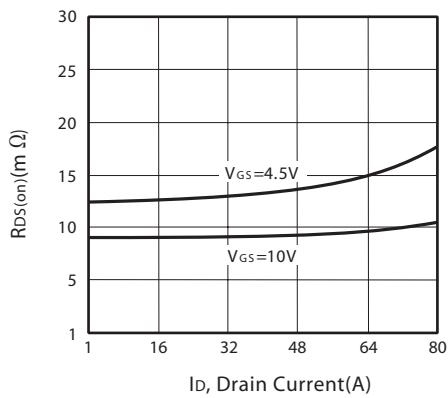

Figure 3. On-Resistance vs. Drain Current and Gate Voltage

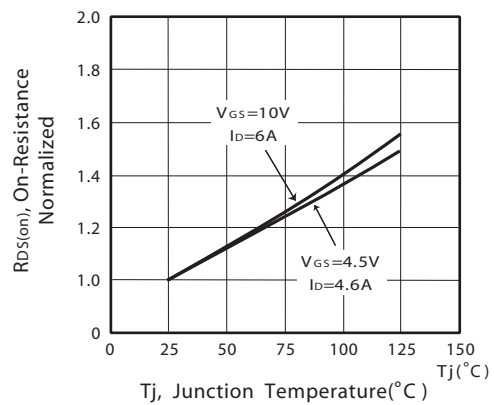

Figure 4. On-Resistance Variation with Drain Current and Temperature

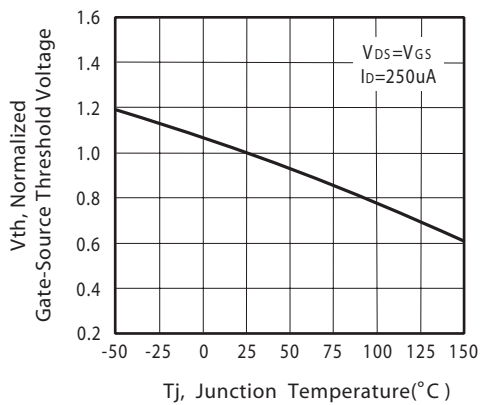

Figure 5. Gate Threshold Variation with Temperature

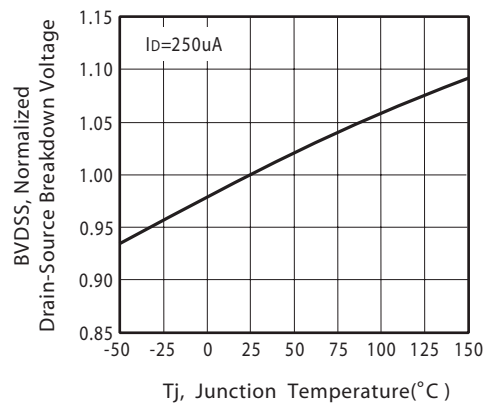

Figure 6. Breakdown Voltage Variation with Temperature

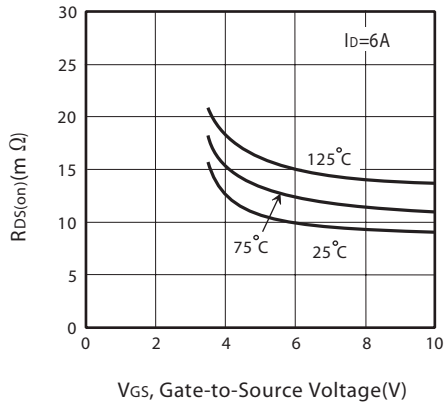

Figure 7. On-Resistance vs. Gate-Source Voltage

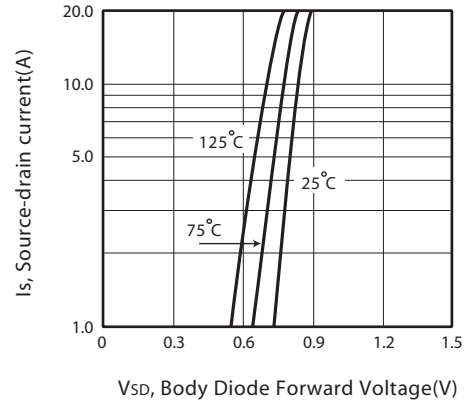

Figure 8. Body Diode Forward Voltage Variation with Source Current

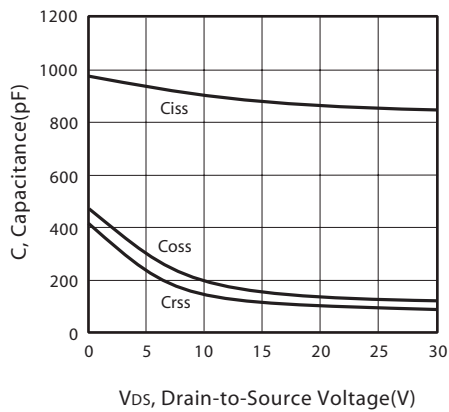

Figure 9. Capacitance

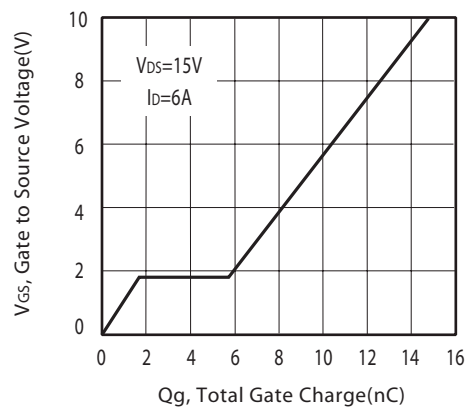

Figure 10. Gate Charge

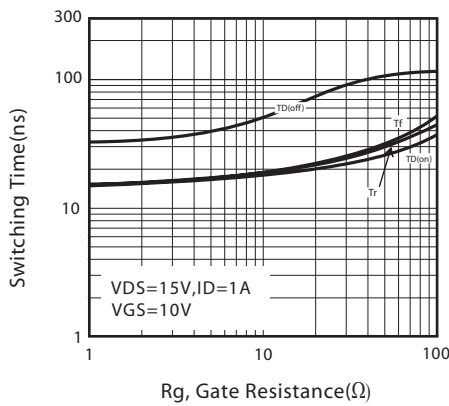

Figure 11. switching characteristics

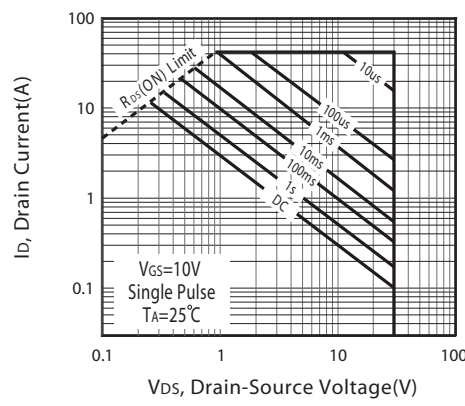

Figure 12. Maximum Safe Operating Area

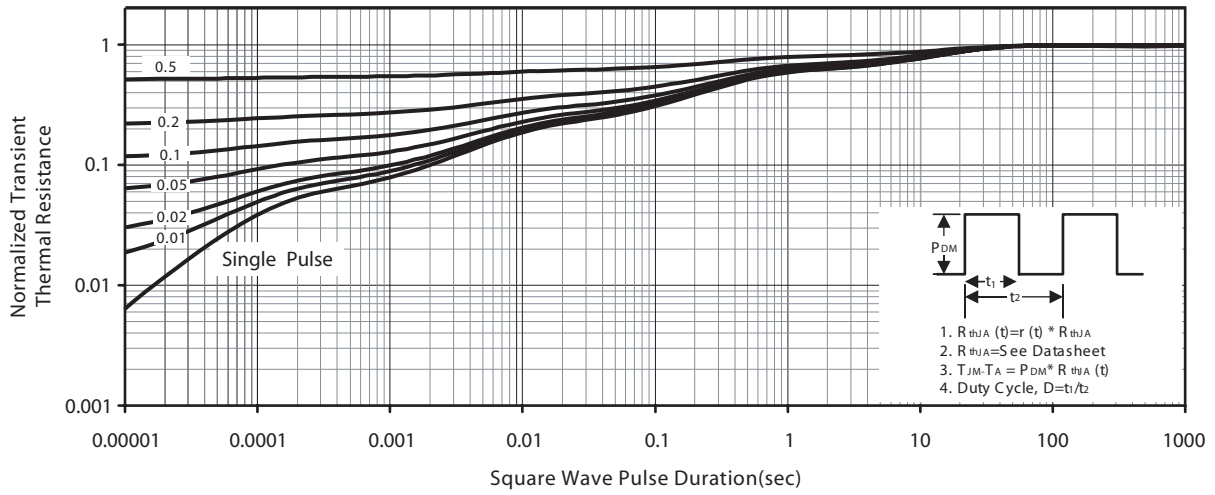
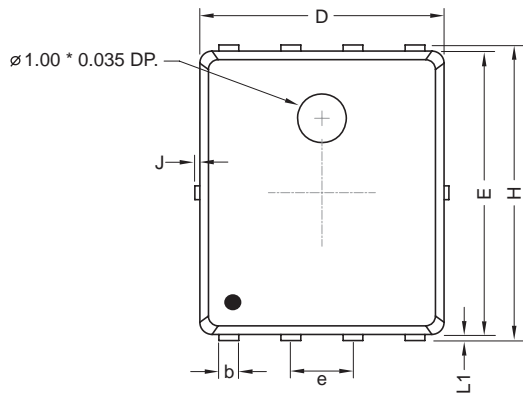

Figure 13. Normalized Thermal Transient Impedance Curve

PACKAGE OUTLINE DIMENSIONS

Power Pak 5 x 6



TOP VIEW

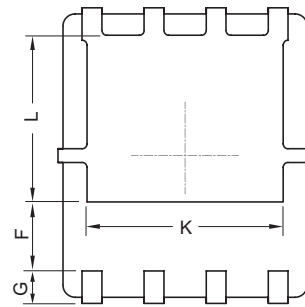

BOTTOM VIEW

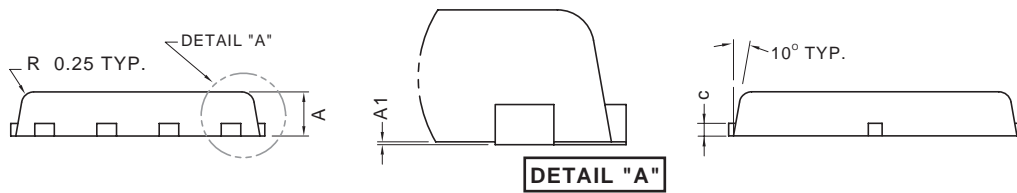

SIDE VIEW

SYMBOLS	MILLIMETERS	
	MIN	MAX
A	0.800	1.000
A1	0.000	0.050
b	0.350	0.490
c	0.254 Ref.	
D	4.900	5.100
F	1.400 Ref.	
E	5.700	5.900
e	1.270 BSC.	
H	5.950	6.200
L1	0.100	0.180
G	0.600 Ref.	
K	4.000 Ref.	
J	—	0.150
L	3.400 Ref.	