



## Dual N-Channel Enhancement Mode Field Effect Transistor

PRODUCT SUMMARY		
V <sub>DSS</sub>	I <sub>D</sub>	R <sub>DS(ON)</sub> (mΩ) Max
24V	10A	9.5 @ V <sub>GS</sub> =4.5V
		10.2 @ V <sub>GS</sub> =4.0V
		10.4 @ V <sub>GS</sub> =3.7V
		11.5 @ V <sub>GS</sub> =3.1V
		14.0 @ V <sub>GS</sub> =2.5V

### FEATURES

- Super high dense cell design for low R<sub>DS(ON)</sub>.
- Rugged and reliable.
- Surface Mount Package.
- ESD Protected.

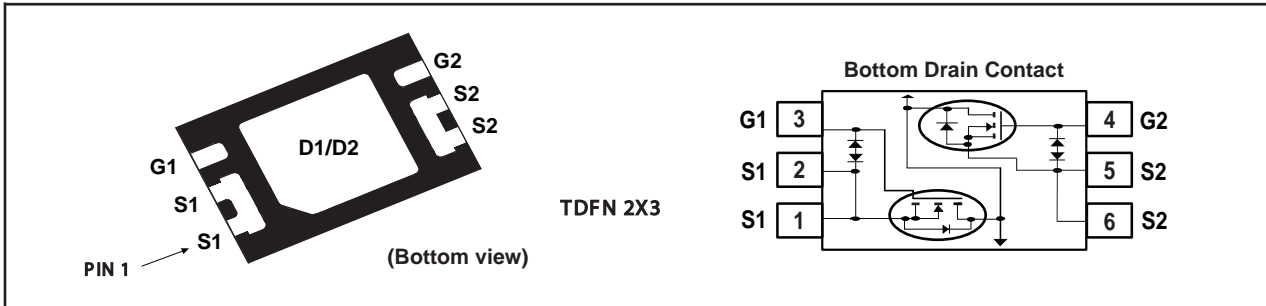

### ABSOLUTE MAXIMUM RATINGS (T<sub>A</sub>=25°C unless otherwise noted)

Symbol	Parameter	Limit	Units
V <sub>DS</sub>	Drain-Source Voltage	24	V
V <sub>GS</sub>	Gate-Source Voltage	±12	V
I <sub>D</sub>	Drain Current-Continuous <sup>a</sup>	T <sub>A</sub> =25°C	10.0
		T <sub>A</sub> =70°C	8.0
I <sub>DM</sub>	-Pulsed <sup>b</sup>	60	A
P <sub>D</sub>	Maximum Power Dissipation <sup>a</sup>	T <sub>A</sub> =25°C	1.56
		T <sub>A</sub> =70°C	1.00
T <sub>J</sub> , T <sub>STG</sub>	Operating Junction and Storage Temperature Range	-55 to 150	°C

### THERMAL CHARACTERISTICS

R <sub>θJA</sub>	Thermal Resistance, Junction-to-Ambient <sup>a</sup>	80	°C/W
------------------	--	----	------

# STF2458

Ver 1.1

## ELECTRICAL CHARACTERISTICS (T<sub>A</sub>=25°C unless otherwise noted)

Symbol	Parameter	Conditions	Min	Typ	Max	Units
<b>OFF CHARACTERISTICS</b>						
BV <sub>DSS</sub>	Drain-Source Breakdown Voltage	V <sub>GS</sub> =0V, I <sub>D</sub> =250uA	24			V
I <sub>DSS</sub>	Zero Gate Voltage Drain Current	V <sub>DS</sub> =20V, V <sub>GS</sub> =0V			1	uA
I <sub>GSS</sub>	Gate-Body Leakage Current	V <sub>GS</sub> = ±12V, V <sub>DS</sub> =0V			±10	uA
<b>ON CHARACTERISTICS</b>						
V <sub>GS(th)</sub>	Gate Threshold Voltage	V <sub>DS</sub> =V <sub>GS</sub> , I <sub>D</sub> =1.0mA	0.5	0.85	1.5	V
R <sub>DS(ON)</sub>	Drain-Source On-State Resistance	V <sub>GS</sub> =4.5V, I <sub>D</sub> =5.0A	6.0	7.5	9.5	m ohm
		V <sub>GS</sub> =4.0V, I <sub>D</sub> =5.0A	6.2	7.7	10.2	m ohm
		V <sub>GS</sub> =3.7V, I <sub>D</sub> =5.0A	6.4	7.9	10.4	m ohm
		V <sub>GS</sub> =3.1V, I <sub>D</sub> =5.0A	7.0	8.6	11.5	m ohm
		V <sub>GS</sub> =2.5V, I <sub>D</sub> =5.0A	8.0	10.4	14.0	m ohm
g <sub>FS</sub>	Forward Transconductance	V <sub>DS</sub> =5V, I <sub>D</sub> =5.0A		24		S
<b>DYNAMIC CHARACTERISTICS <sup>c</sup></b>						
C <sub>ISS</sub>	Input Capacitance	V <sub>DS</sub> =10V, V <sub>GS</sub> =0V f=1.0MHz		1300		pF
C <sub>OSS</sub>	Output Capacitance			241		pF
C <sub>RSS</sub>	Reverse Transfer Capacitance			217		pF
<b>SWITCHING CHARACTERISTICS <sup>c</sup></b>						
t <sub>D(ON)</sub>	Turn-On Delay Time	V <sub>DD</sub> =20V I <sub>D</sub> =5.0A		29		ns
t <sub>r</sub>	Rise Time			85		ns
t <sub>D(OFF)</sub>	Turn-Off Delay Time	V <sub>GS</sub> =4.5V R <sub>GEN</sub> =6 ohm		66		ns
t <sub>f</sub>	Fall Time			35		ns
Q <sub>g</sub>	Total Gate Charge	V <sub>DS</sub> =20V, I <sub>D</sub> =10.0A, V <sub>GS</sub> =4.5V		14		nC
Q <sub>gs</sub>	Gate-Source Charge			2.7		nC
Q <sub>gd</sub>	Gate-Drain Charge			7.0		nC
<b>DRAIN-SOURCE DIODE CHARACTERISTICS AND MAXIMUM RATINGS</b>						
V <sub>SD</sub>	Diode Forward Voltage	V <sub>GS</sub> =0V, I <sub>S</sub> =10A		0.83	1.2	V
<b>Notes</b>						
a.Surface Mounted on FR4 Board, t ≤ 10sec.						
b.Pulse Test:Pulse Width < 10us, Duty Cycle < 1%.						
c.Guaranteed by design, not subject to production testing.						

Sep,24,2013

# STF2458

Ver 1.1

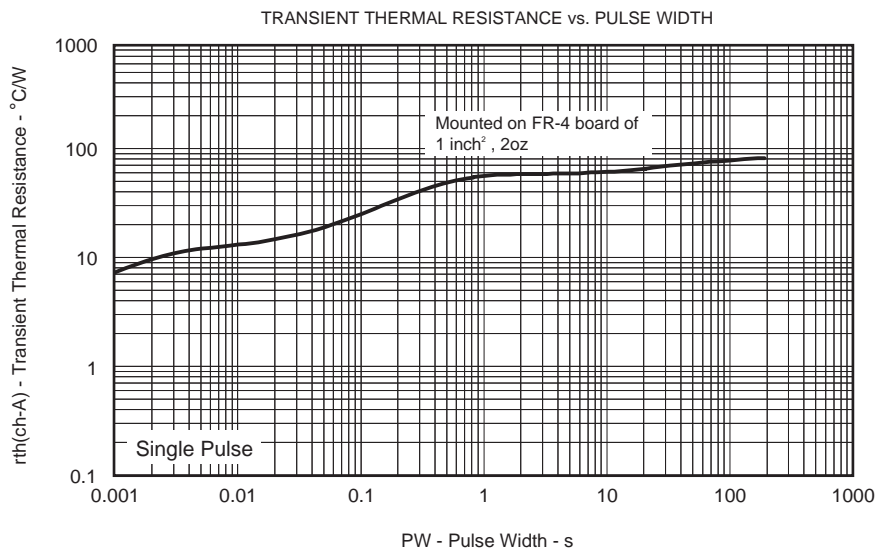
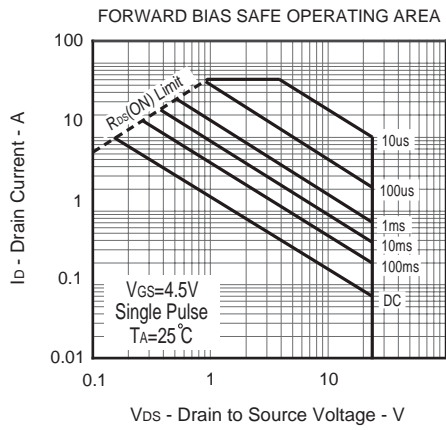
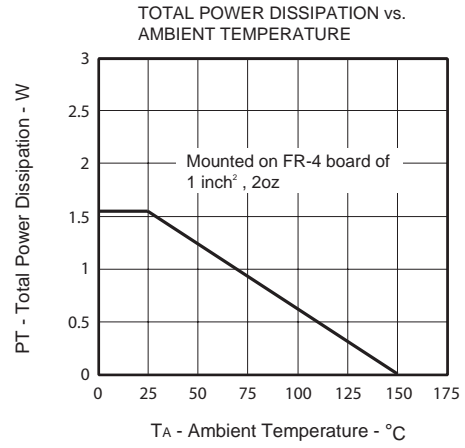
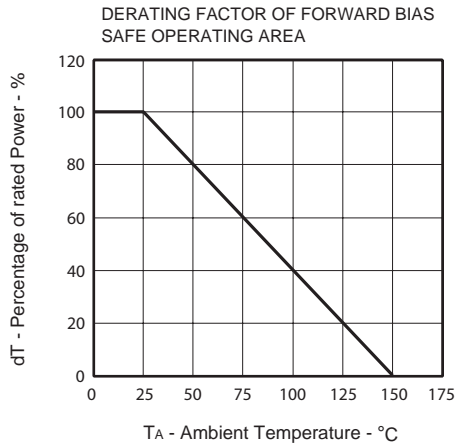

Sep,24,2013

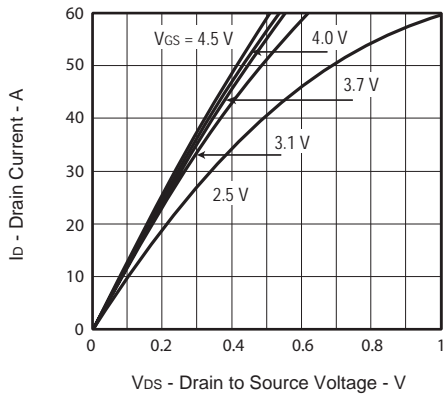

FORWARD TRANSFER CHARACTERISTICS

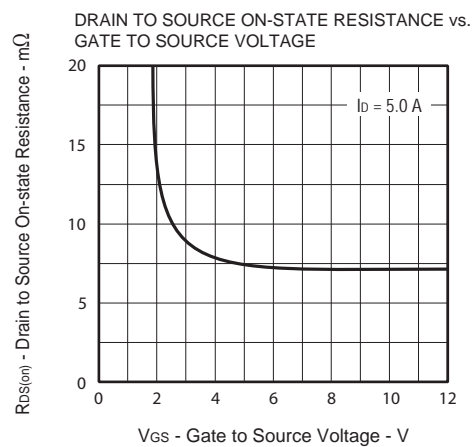
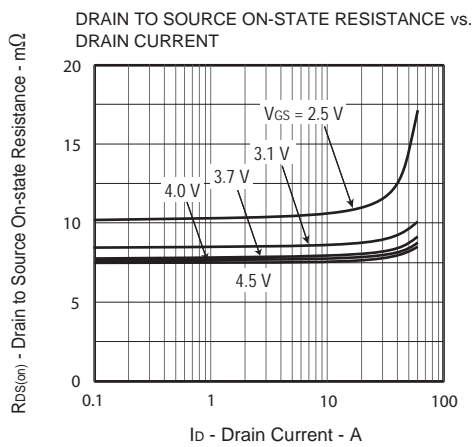
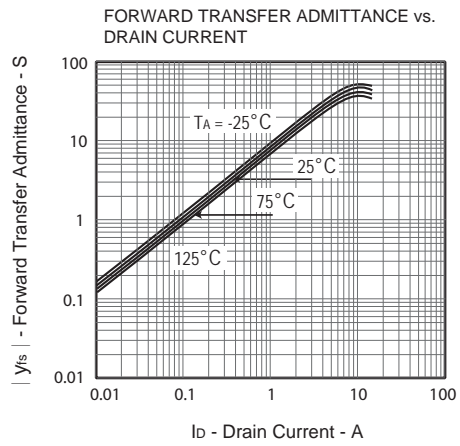
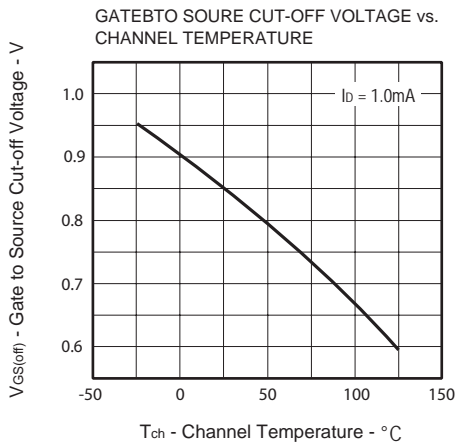
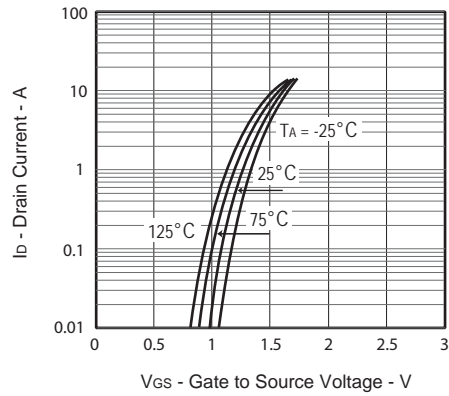

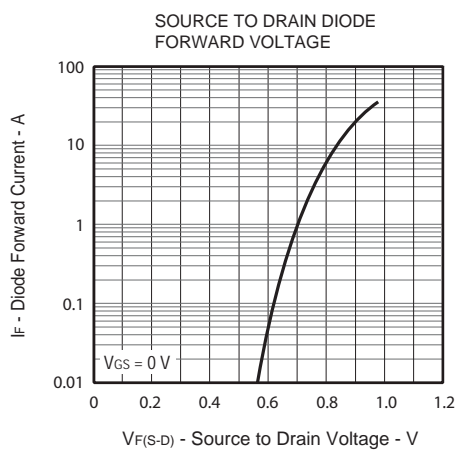
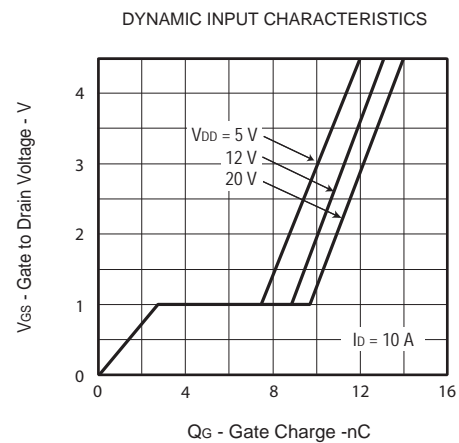
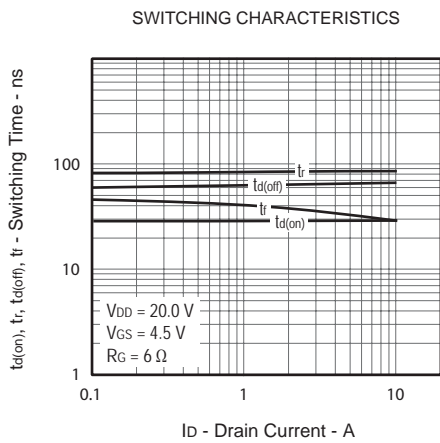
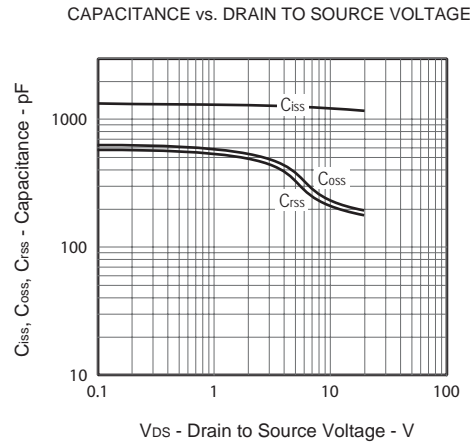
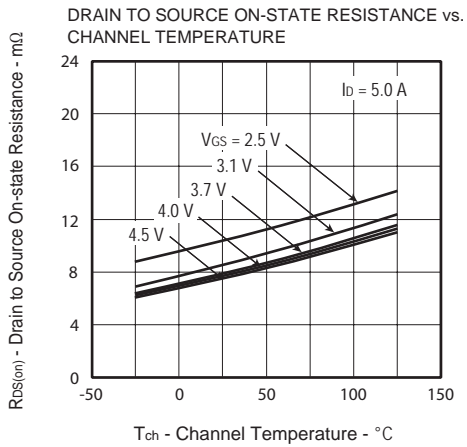

## PACKAGE OUTLINE DIMENSIONS

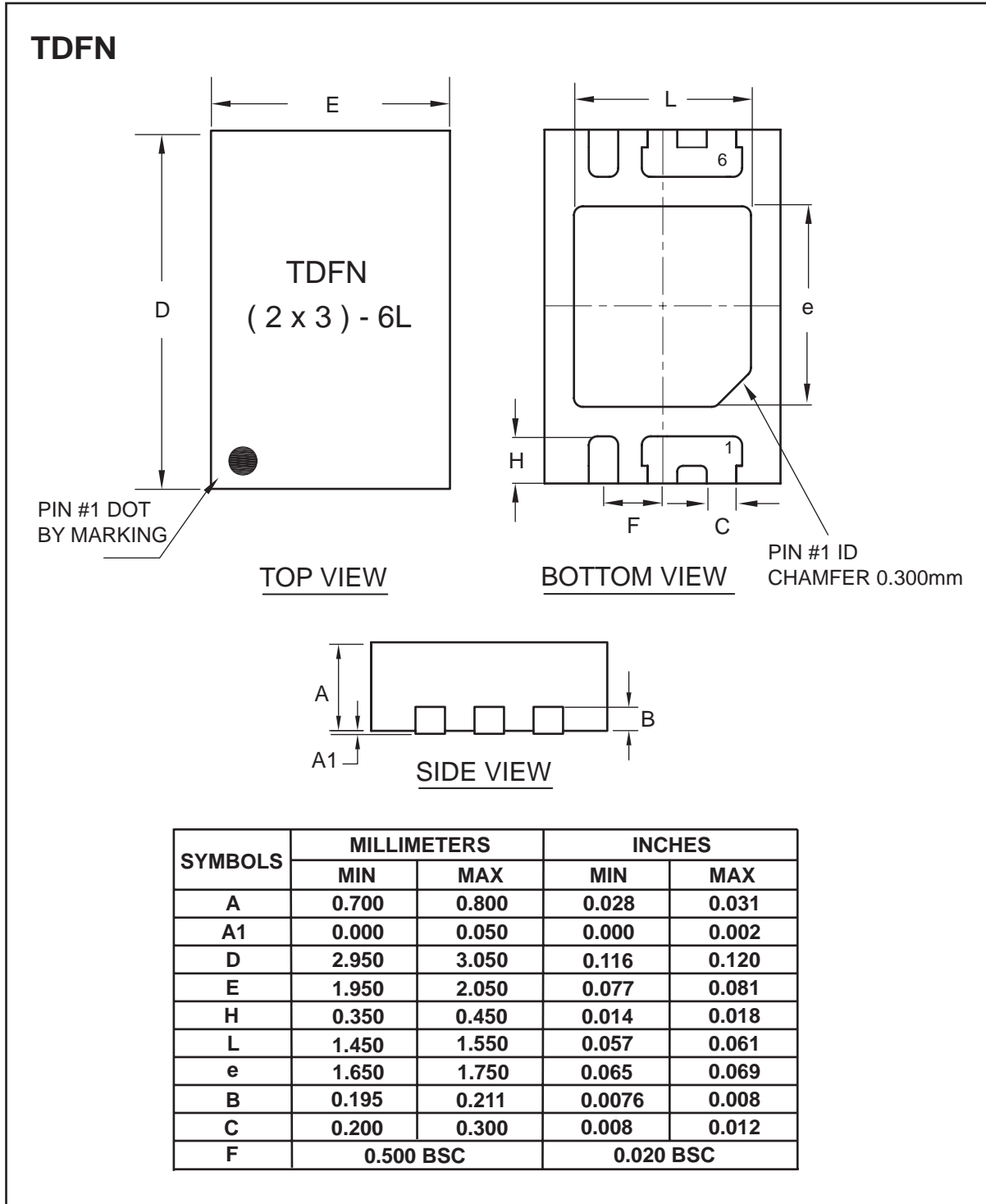

## TOP MARKING DEFINITION

