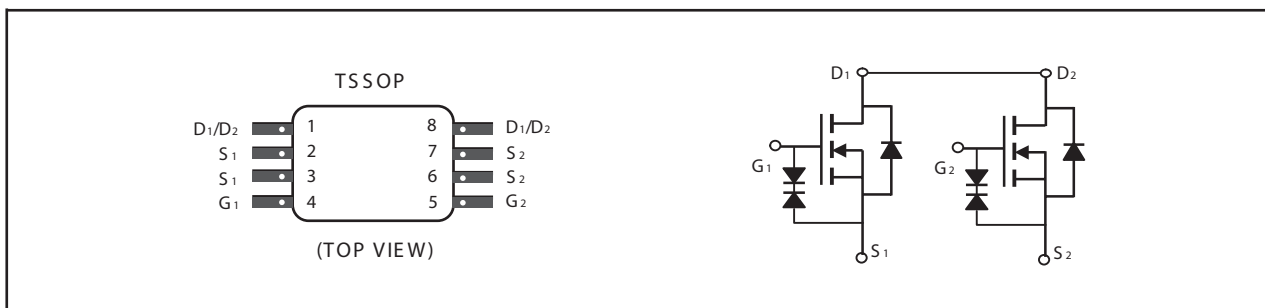

**Dual N-Channel Enhancement Mode Field Effect Transistor**

PRODUCT SUMMARY		
VDSS	ID	RDS(ON) (mΩ) Max
24V	7A	17 @ VGS=4.0V
		29 @ VGS=2.5V

FEATURES

- Super high dense cell design for low RDS(ON).
- Rugged and reliable.
- Surface Mount Package.
- ESD Protected.

**ABSOLUTE MAXIMUM RATINGS (TA=25°C unless otherwise noted)**

Symbol	Parameter	Limit	Units
V _{DS}	Drain-Source Voltage	24	V
V _{GS}	Gate-Source Voltage	±12	V
I _D	Drain Current-Continuous ^a	T _A =25°C	7
		T _A =70°C	5.6
I _{DM}	-Pulsed ^b	28.5	A
P _D	Maximum Power Dissipation ^a	T _A =25°C	1.5
		T _A =70°C	1
T _J , T _{STG}	Operating Junction and Storage Temperature Range	-55 to 150	°C

THERMAL CHARACTERISTICS

R _{θJA}	Thermal Resistance, Junction-to-Ambient ^a	85	°C/W
------------------	--	----	------

STG2454

Ver 1.1

ELECTRICAL CHARACTERISTICS (T_A=25°C unless otherwise noted)

Symbol	Parameter	Conditions	Min	Typ	Max	Units
OFF CHARACTERISTICS						
B _V DSS	Drain-Source Breakdown Voltage	V _{GS} =0V , I _D =250uA	24			V
I _{DSS}	Zero Gate Voltage Drain Current	V _{DS} =19V , V _{GS} =0V			1	uA
I _{GSS}	Gate-Body Leakage Current	V _{GS} = ±12V , V _{DS} =0V			±10	uA
ON CHARACTERISTICS						
V _{GS(th)}	Gate Threshold Voltage	V _{DS} =V _{GS} , I _D =250uA	0.5	0.8	1.5	V
R _{DS(ON)}	Drain-Source On-State Resistance	V _{GS} =4.0V , I _D =7A	10	14	17	m ohm
		V _{GS} =2.5V , I _D =6A	13	20	29	m ohm
g _{FS}	Forward Transconductance	V _{DS} =5V , I _D =7A		35		S
DYNAMIC CHARACTERISTICS ^c						
C _{ISS}	Input Capacitance	V _{DS} =10V, V _{GS} =0V f=1.0MHz		730		pF
C _{OSS}	Output Capacitance			200		pF
C _{RSS}	Reverse Transfer Capacitance			180		pF
SWITCHING CHARACTERISTICS ^c						
t _{D(ON)}	Turn-On Delay Time	V _{DD} =10V I _D =1A V _{GS} =4.0V R _{GEN} =6 ohm		23		ns
t _r	Rise Time			83		ns
t _{D(OFF)}	Turn-Off Delay Time			108		ns
t _f	Fall Time			58		ns
Q _g	Total Gate Charge	V _{DS} =10V, I _D =7A, V _{GS} =4.0V		12.5		nC
Q _{gs}	Gate-Source Charge			2		nC
Q _{gd}	Gate-Drain Charge			5		nC
DRAIN-SOURCE DIODE CHARACTERISTICS AND MAXIMUM RATINGS						
V _{SD}	Diode Forward Voltage ^b	V _{GS} =0V, I _S =1.5A		0.78	1.2	V
Notes						
a.Surface Mounted on FR4 Board, t ≤ 10sec.						
b.Pulse Test:Pulse Width ≤ 300us, Duty Cycle ≤ 2%.						
c.Guaranteed by design, not subject to production testing.						

Aug,24,2012

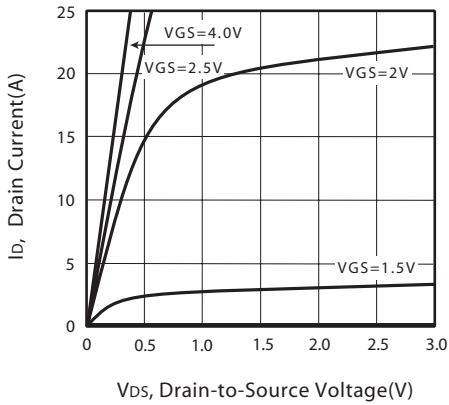

Figure 1. Output Characteristics

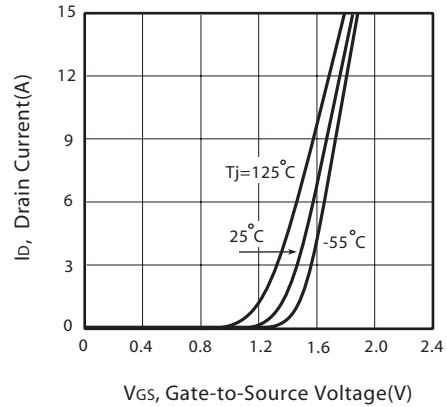

Figure 2. Transfer Characteristics

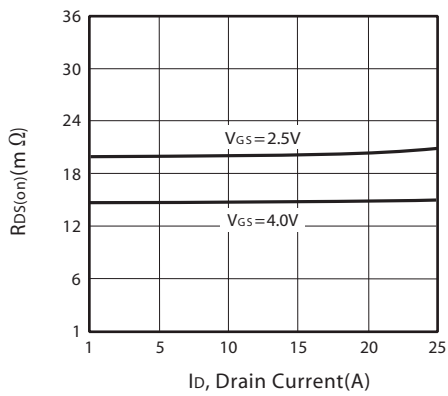

Figure 3. On-Resistance vs. Drain Current and Gate Voltage

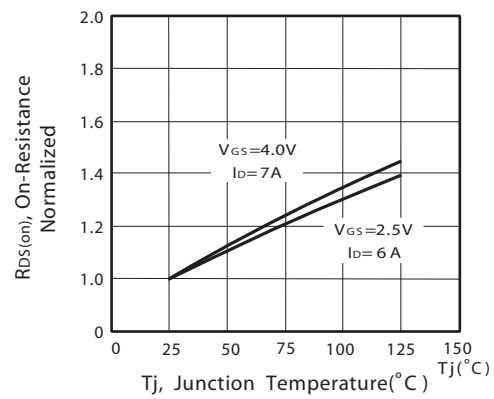

Figure 4. On-Resistance Variation with Drain Current and Temperature

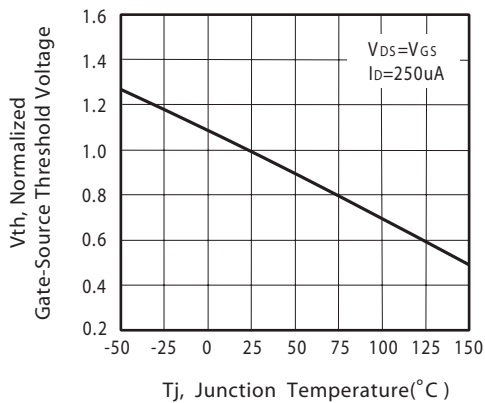

Figure 5. Gate Threshold Variation with Temperature

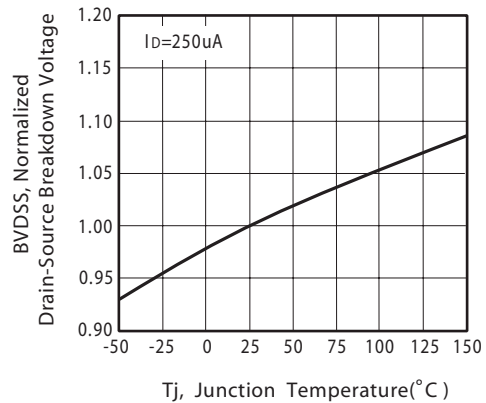

Figure 6. Breakdown Voltage Variation with Temperature

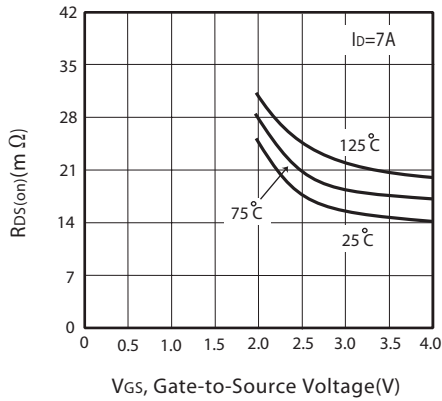

Figure 7. On-Resistance vs. Gate-Source Voltage

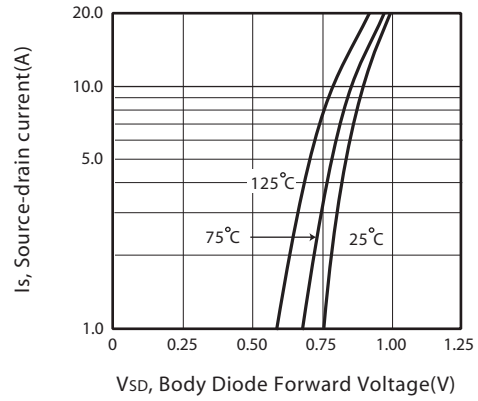

Figure 8. Body Diode Forward Voltage Variation with Source Current

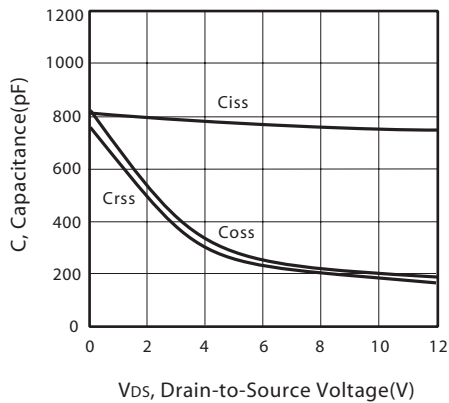

Figure 9. Capacitance

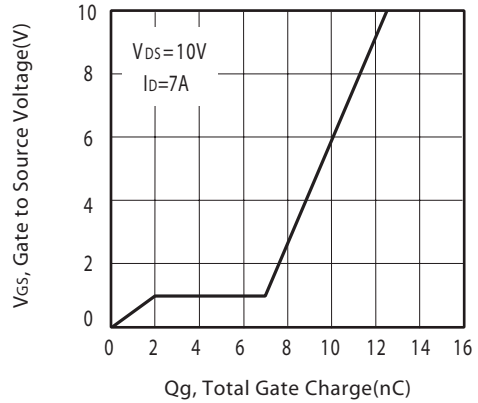

Figure 10. Gate Charge

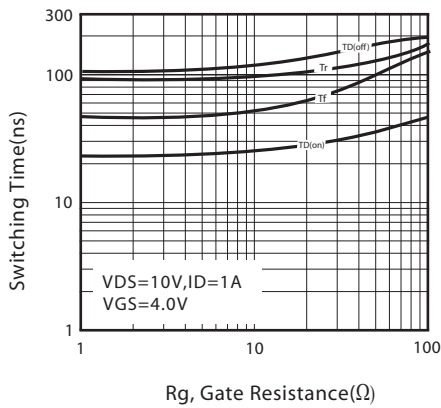

Figure 11. switching characteristics

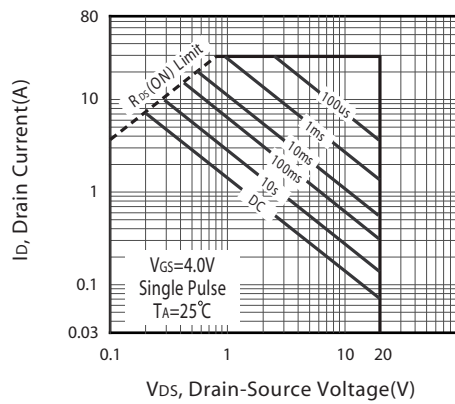
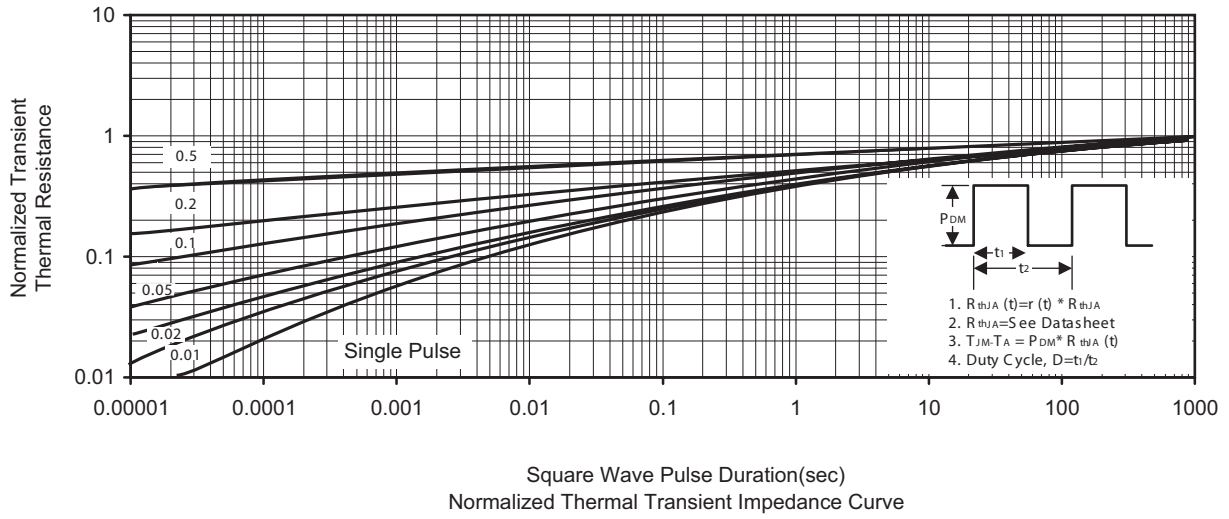

Figure 12. Maximum Safe Operating Area



PACKAGE OUTLINE DIMENSIONS

TSSOP-8

SYMBOLS	MILLIMETERS		INCHES	
	MIN	MAX	MIN	MAX
A	0.85	1.20	0.033	0.047
A1	0.05	0.15	0.002	0.006
A2	0.80	1.05	0.031	0.041
b	0.19	0.30	0.007	0.012
c	0.127		0.005	
D	2.90	3.10 [Ⓢ]	0.114	0.122 [Ⓢ]
E	4.30	4.50 [Ⓢ]	0.169	0.177 [Ⓢ]
E1	6.20	6.60	0.244	0.260
e	0.65BSC		0.025BSC	
L	0.50	0.70	0.020	0.028
L1	1.00		0.039	
θ_1	0°	8°	0°	8°

Notes: 1. This drawing is for general information only. Refer to JEDEC Drawing MO-153, Variation AA, for proper dimensions, tolerances, datums, etc.
 2. Dimension D does not include mold Flash, protrusions or gate burrs. Mold Flash, protrusions and gate burrs shall not exceed 0.15 mm (0.006 in) per side.
 3. Dimension E does not include inter-lead Flash or protrusions. Inter-lead Flash and protrusions shall not exceed 0.25mm (0.010 in) per side.
 4. Dimension b does not include Dambar protrusion. Allowable Dambar protrusion shall be 0.08 mm total in excess of the b dimension at maximum material condition. Dambar cannot be located on the lower radius of the foot. Minimum space between protrusion and adjacent lead is 0.07 mm.
 5. Dimension D and E to be determined at Datum Plane H.

TSSOP-8 Tape and Reel Data

TSSOP-8 Carrier Tape

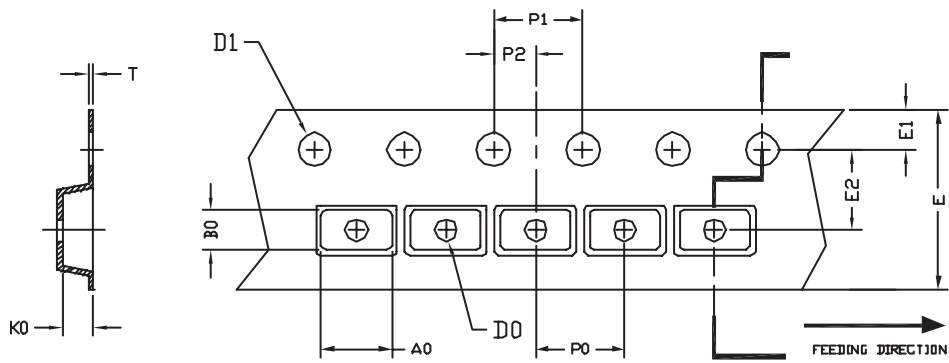

UNIT : mm

PACKAGE	A0	B0	K0	D0	D1	E	E1	E2	P0	P1	P2	T
TSSOP 8	6.08	4.40	1.60	$\phi 1.50$ +0.1 -0.0	$\phi 1.50$ +0.1 -0.0	12.00 ± 0.3	1.75	5.50 ± 0.05	8.00	4.00	2.00 ± 0.05	0.30 ± 0.05

TSSOP-8 Reel

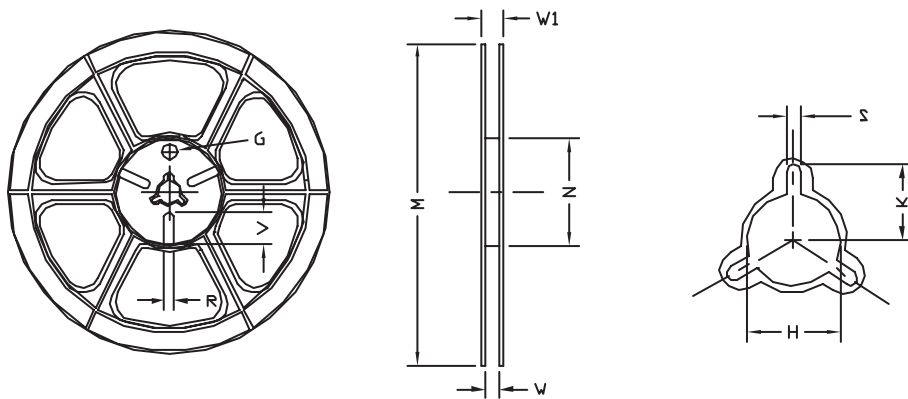

UNIT : mm

TAPE SIZE	REEL SIZE	M	N	W	W1	H	K	S	G	R	V
12 mm	$\phi 330$	330	100	12.5	16.0	$\phi 13.0$ +0.5 -0.2	10.6	2.0 ± 0.5	---	---	---