



STM4470

SamHop Microelectronics Corp.

Oct. 16. 2006 Ver1.1

N-Channel Enhancement Mode Field Effect Transistor

PRODUCT SUMMARY		
V_{DS}^d	I_D	$R_{DS(ON)}$ (m Ω) Max
40V	10A	10 @ $V_{GS} = 10V$
		13 @ $V_{GS} = 4.5V$

FEATURES

- Super high dense cell design for low $R_{DS(ON)}$.
- Rugged and reliable.
- Surface Mount Package.



ABSOLUTE MAXIMUM RATINGS ($T_A=25^\circ C$ unless otherwise noted)

Parameter	Symbol	Limit	Unit
Drain-Source Voltage	V_{DS}^d	40	V
Gate-Source Voltage	V_{GS}	± 20	V
Drain Current-Continuous ^a @ $T_J=25^\circ C$ -Pulsed ^b	I_D	10	A
	I_{DM}	39	A
Drain-Source Diode Forward Current ^a	I_S	1.7	A
Maximum Power Dissipation ^a	PD	2.5	W
Operating Junction and Storage Temperature Range	T_J, T_{STG}	-55 to 150	$^\circ C$

THERMAL CHARACTERISTICS

Thermal Resistance, Junction-to-Ambient ^a	$R_{\theta A}$	50	$^\circ C/W$
--	----------------	----	--------------

STM4470

ELECTRICAL CHARACTERISTICS (TA=25°C unless otherwise noted)

Parameter	Symbol	Condition	Min	Typ ^c	Max	Unit
OFF CHARACTERISTICS						
Drain-Source Breakdown Voltage ^d	BV _{DSS}	V _{GS} = 0V, I _D = 250uA	40			V
Zero Gate Voltage Drain Current	I _{DSS}	V _{DS} = 32V, V _{GS} = 0V			1	uA
Gate-Body Leakage	I _{GSS}	V _{GS} = ±20V, V _{DS} = 0V			±100	nA
ON CHARACTERISTICS^b						
Gate Threshold Voltage	V _{GS(th)}	V _{DS} = V _{GS} , I _D = 250uA	1	1.7	3	V
Drain-Source On-State Resistance	R _{DS(ON)}	V _{GS} = 10V, I _D = 10A		8	10	m ohm
		V _{GS} = 4.5V, I _D = 6A		11	13	m ohm
On-State Drain Current	I _{D(ON)}	V _{DS} = 10V, V _{GS} = 10V	20			A
Forward Transconductance	g _{FS}	V _{DS} = 10V, I _D = 10A		20		S
DYNAMIC CHARACTERISTICS^c						
Input Capacitance	C _{ISS}	V _{DS} = 20V, V _{GS} = 0V f = 1.0MHz		1020		pF
Output Capacitance	C _{OSS}			240		pF
Reverse Transfer Capacitance	C _{RSS}			135		pF
SWITCHING CHARACTERISTICS^c						
Turn-On Delay Time	t _{D(ON)}	V _{DD} = 20V I _D = 1A V _{GS} = 10V R _{GEN} = 3.3 ohm		15		ns
Rise Time	t			22		ns
Turn-Off Delay Time	t _{D(OFF)}			48		ns
Fall Time	t			12		ns
Total Gate Charge	Q _g	V _{DS} = 20V, I _D = 10A, V _{GS} = 10V		19.5		nC
		V _{DS} = 20V, I _D = 10A, V _{GS} = 4.5V		9.8		nC
Gate-Source Charge	Q _{gs}	V _{DS} = 20V, I _D = 10A		2		nC
Gate-Drain Charge	Q _{gd}	V _{GS} = 10V		5.5		nC

STM4470

ELECTRICAL CHARACTERISTICS ($T_A=25\text{ }^\circ\text{C}$ unless otherwise noted)

Parameter	Symbol	Condition	Min	Typ ^c	Max	Unit
DRAIN-SOURCE DIODE CHARACTERISTICS ^b						
Diode Forward Voltage	V_{SD}	$V_{GS} = 0V, I_S = 1.7A$		0.73	1.2	V

Notes

- a. Surface Mounted on FR4 Board, $t \leq 10\text{sec}$.
- b. Pulse Test: Pulse Width $\leq 300\mu\text{s}$, Duty Cycle $\leq 2\%$.
- c. Guaranteed by design, not subject to production testing.
- d. Guaranteed when external $R_g = 3.3\text{ ohm}$ and $t_f < t_{f\text{ max}}$

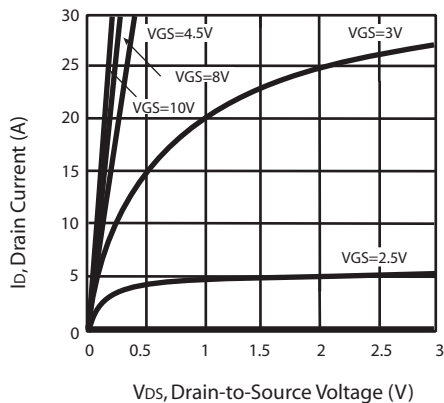

Figure 1. Output Characteristics

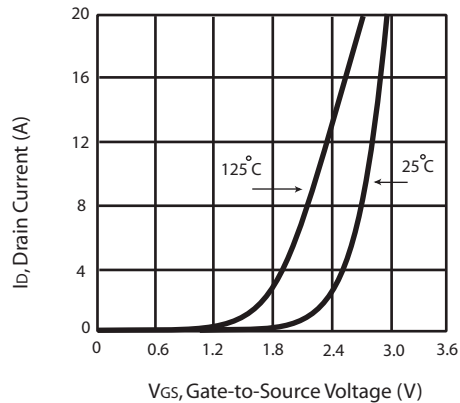

Figure 2. Transfer Characteristics

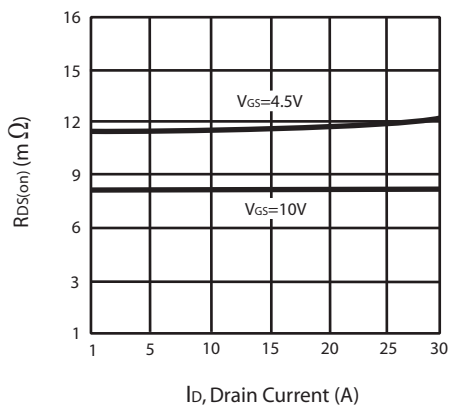

Figure 3. On-Resistance vs. Drain Current and Gate Voltage

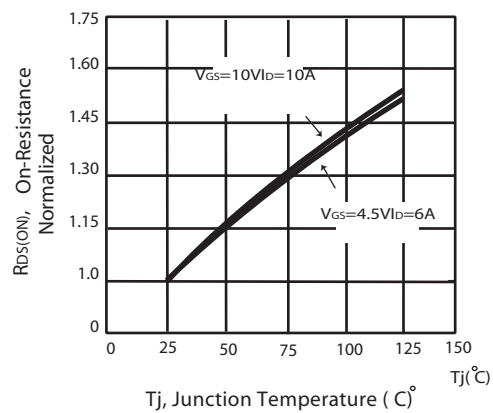

Figure 4. On-Resistance Variation with Drain Current and Temperature

STM4470

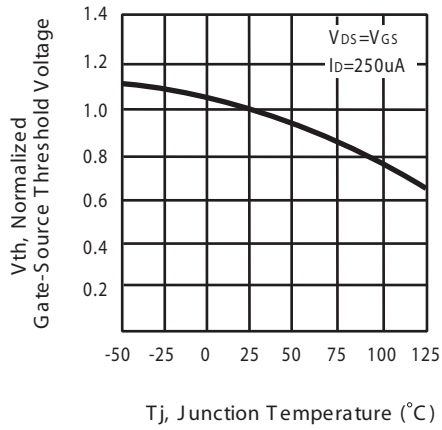

Figure 5. Gate Threshold Variation with Temperature

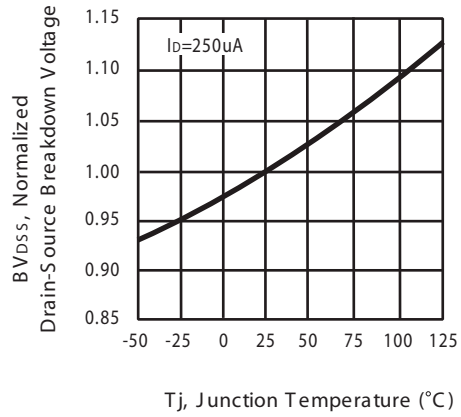

Figure 6. Breakdown Voltage Variation with Temperature

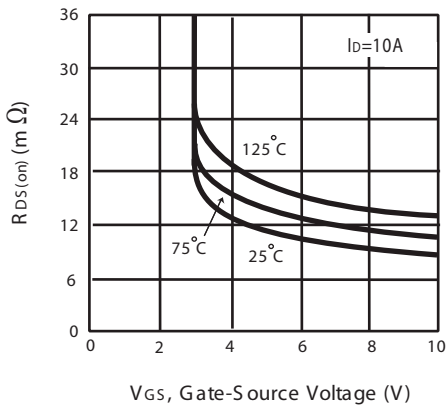

Figure 7. On-Resistance vs. Gate-Source Voltage

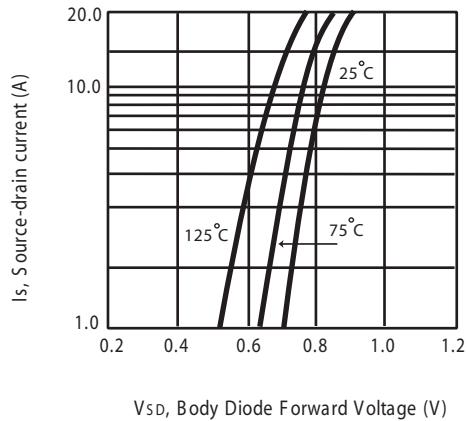

Figure 8. Body Diode Forward Voltage Variation with Source Current

STM4470

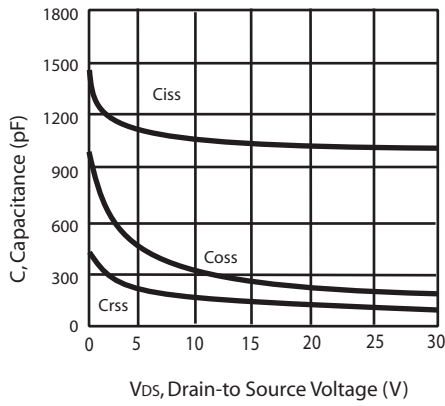

Figure 9. Capacitance

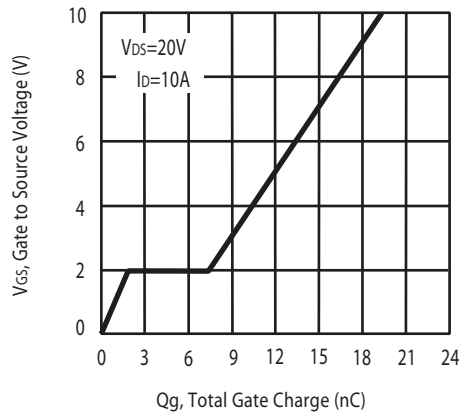

Figure 10. Gate Charge

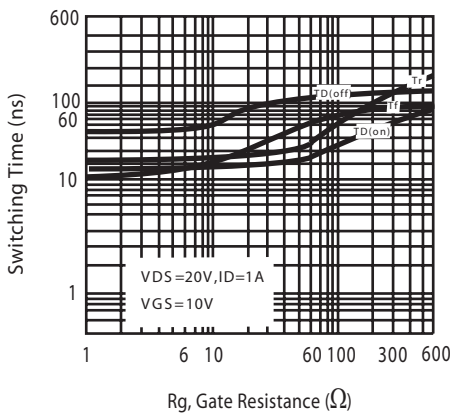

Figure 11. switching characteristics

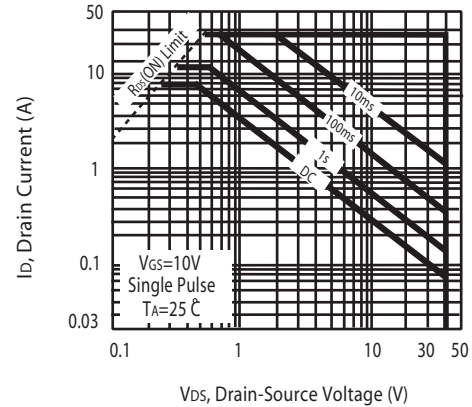
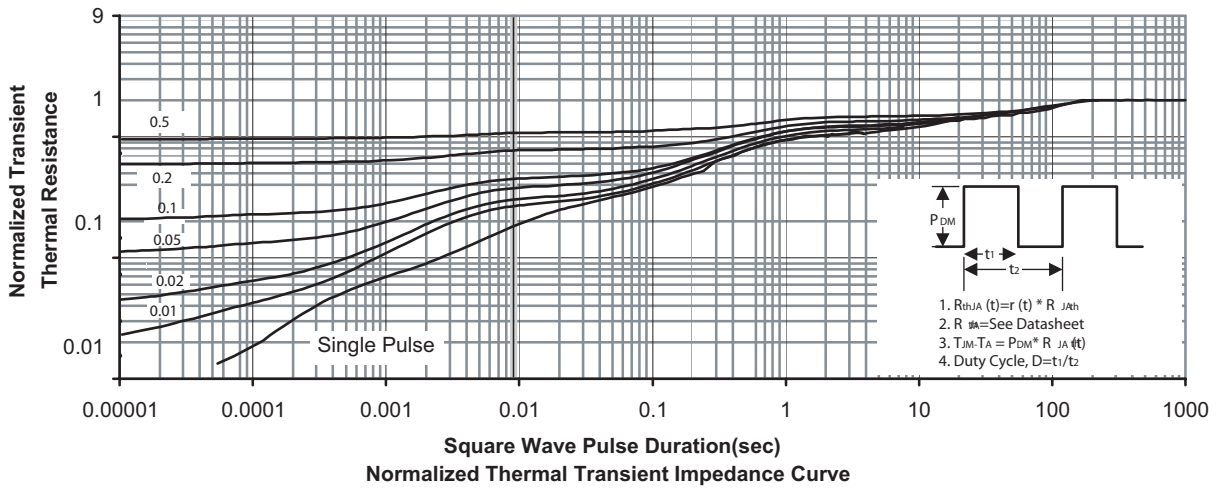

Figure 12. Maximum Safe Operating Area



STM4470

PACKAGE OUTLINE DIMENSIONS

SO-8

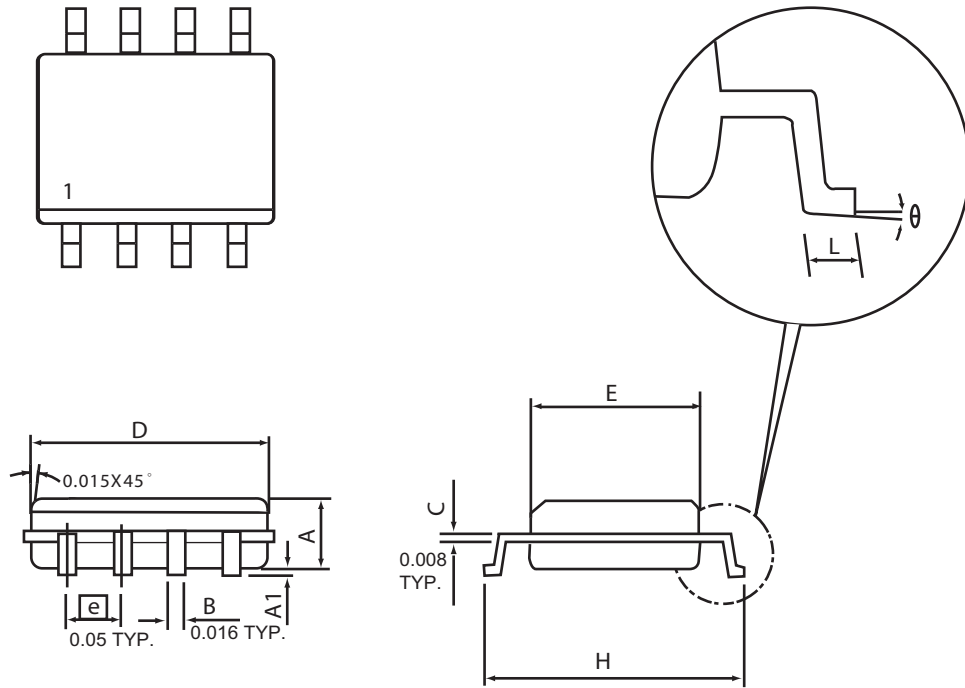

SYMBOLS	MILLIMETERS		INCHES	
	MIN	MAX	MIN	MAX
A	1.35	1.75	0.053	0.069
A1	0.10	0.25	0.004	0.010
D	4.80	4.98	0.189	0.196
E	3.81	3.99	0.150	0.157
H	5.79	6.20	0.228	0.244
L	0.41	1.27	0.016	0.050
θ	0°	8°	0°	8°

STM4470

SO-8 Tape and Reel Data

SO-8 Carrier Tape

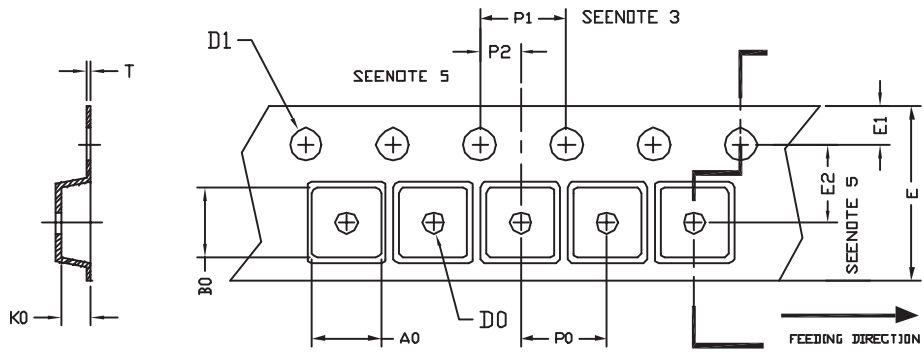

unit:mm

PACKAGE	A0	B0	K0	D0	D1	E	E1	E2	P0	P1	P2	T
SOP 8N 150mil	6.40	5.20	2.10	$\phi 1.5$ (MIN)	$\phi 1.5$ + 0.1 - 0.0	12.0 ± 0.3	1.75	5.5 ± 0.05	8.0	4.0	2.0 ± 0.05	0.3 ± 0.05

SO-8 Reel

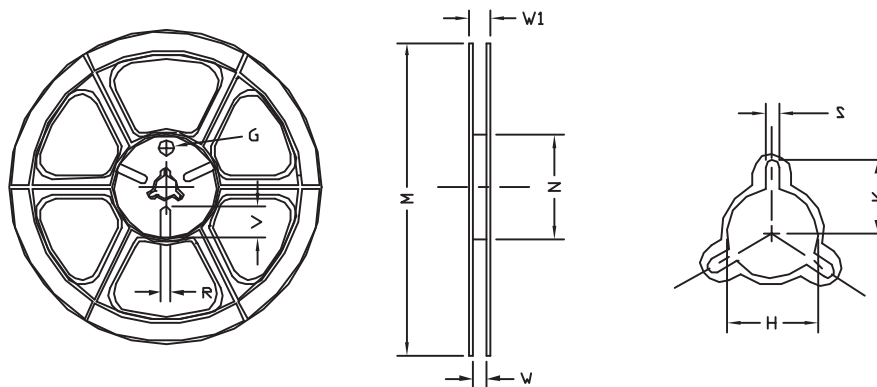

UNIT:mm

TAPE SIZE	REEL SIZE	M	N	W	W1	H	K	S	G	R	V
12 mm	$\phi 330$	330 ± 1	62 ± 1.5	12.4 + 0.2	16.8 - 0.4	$\phi 12.75$ + 0.15	---	2.0 ± 0.15	---	---	---